

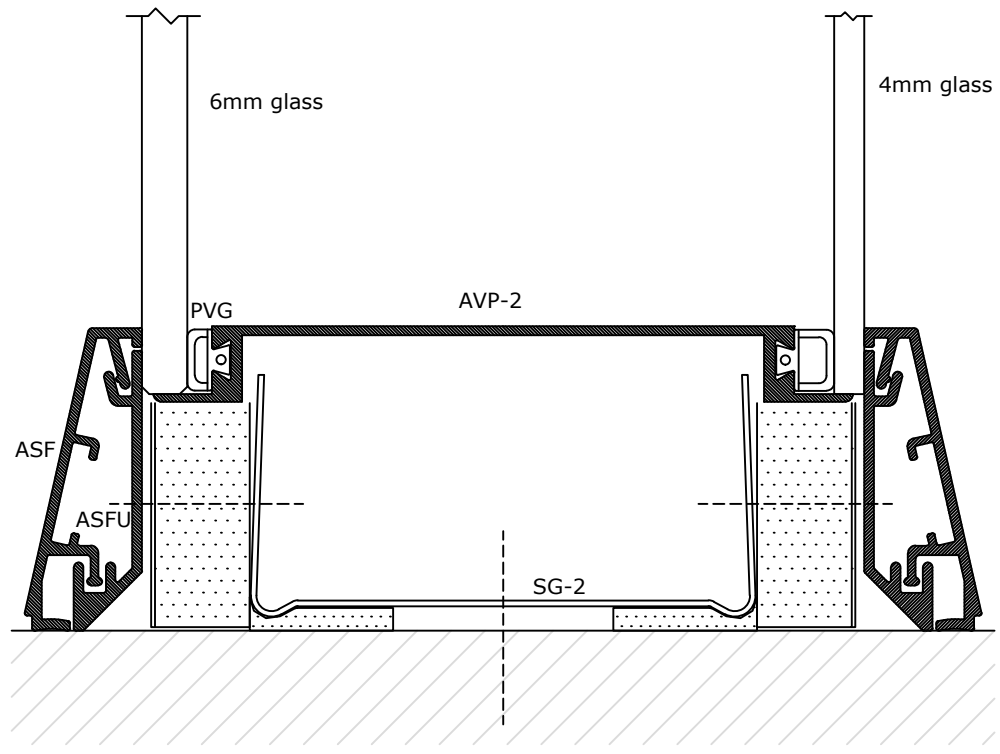

	DEKO Tlf./Tel: +45 43 55 77 11 www.deko.dk / www.deko.com	Projekt/Project: DEKO GV 1090	
	Sags Nr./Case No.: 	Emne/Subject: L3B	Dato/Date:
Mål/Scale: 1:1	 	Revideret/Revision: 2016-10-06-VXX	Signatur Signature EBR



	DEKO Tlf./Tel: +45 43 55 77 11 www.deko.dk / www.deko.com	Projekt/Project: DEKO GV 1090	
	Sags Nr./Case No.:	Emne/Subject: L3E	Dato/Date:
Mål/Scale: 1:1		Revideret/Revision: 2016-10-06-VXX	Signatur Signature EBR

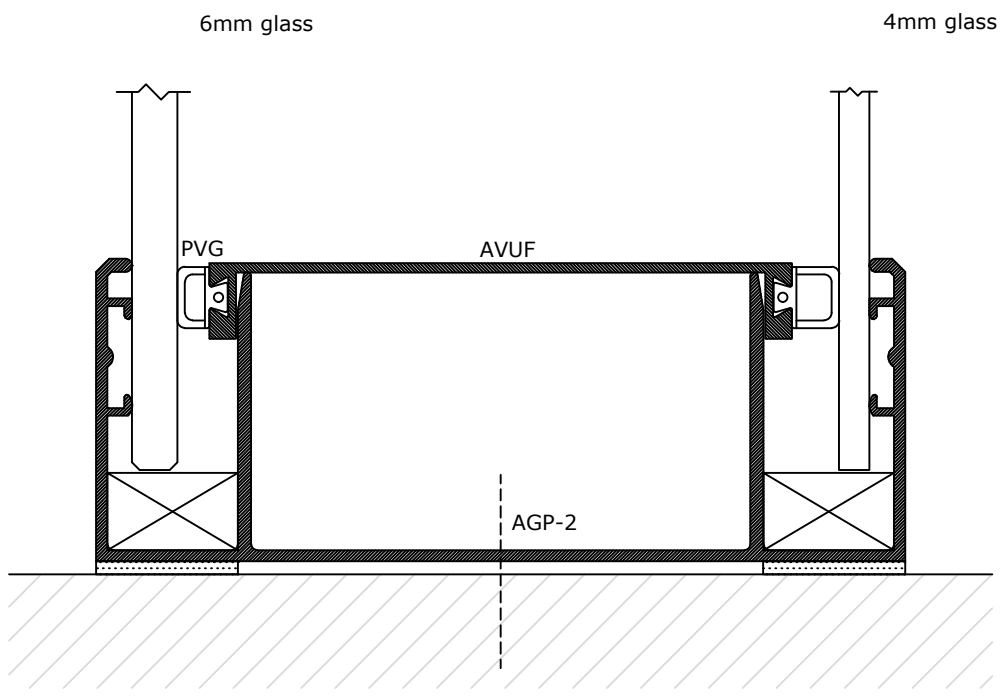

	DEKO Tlf./Tel: +45 43 55 77 11 www.deko.dk / www.deko.com	Projekt/Project: DEKO GV 1090	
	Sags Nr./Case No.: 	Emne/Subject: L3H	Dato/Date:
Mål/Scale: 1:1	 	Revideret/Revision: 2016-10-06-VXX	Signatur Signature EBR

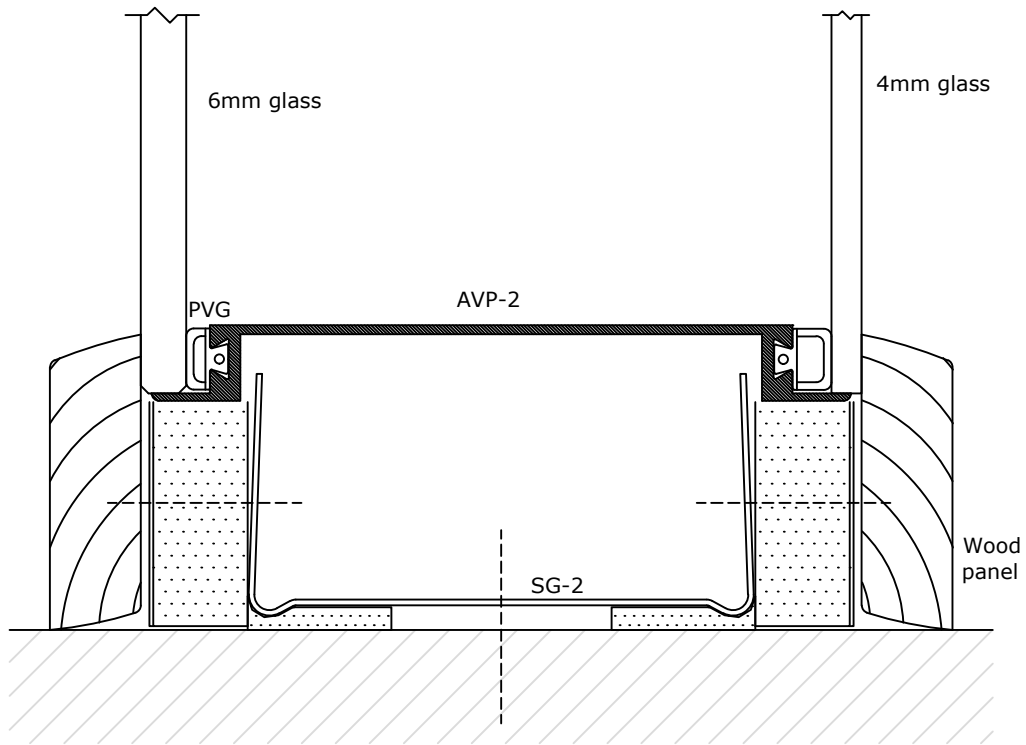

	DEKO Tlf./Tel: +45 43 55 77 11 www.deko.dk / www.deko.com	Projekt/Project: DEKO GV 1090	
	Sags Nr./Case No.: L3J	Emne/Subject:	Dato/Date:
Mål/Scale: 1:1		Revideret/Revision: 2016-10-06-VXX	Signatur Signature EBR

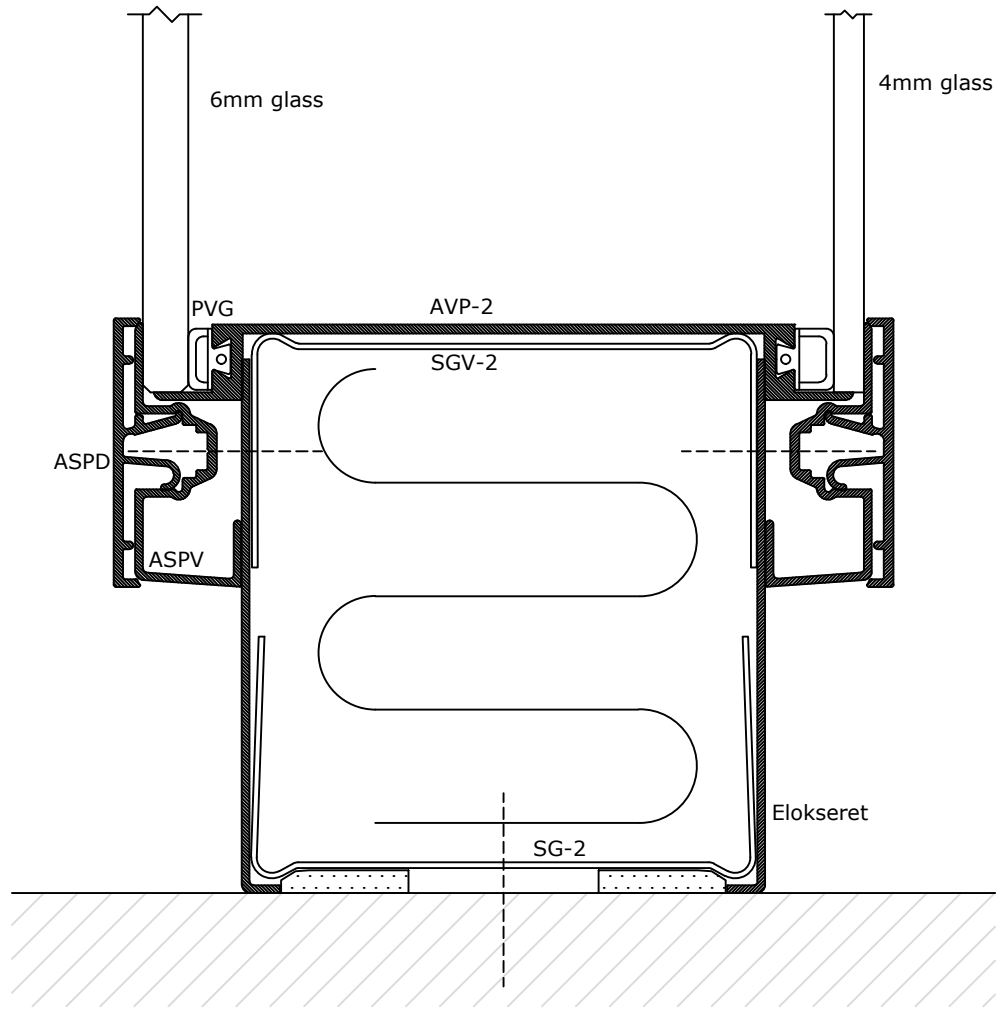

	DEKO Tlf./Tel: +45 43 55 77 11 www.deko.dk / www.deko.com	Projekt/Project: DEKO GV 1090	
	Sags Nr./Case No.: L3K	Emne/Subject: L3K	Dato/Date:
Mål/Scale: 1:1		Revideret/Revision: 2016-10-06-VXX	Signatur Signature EBR

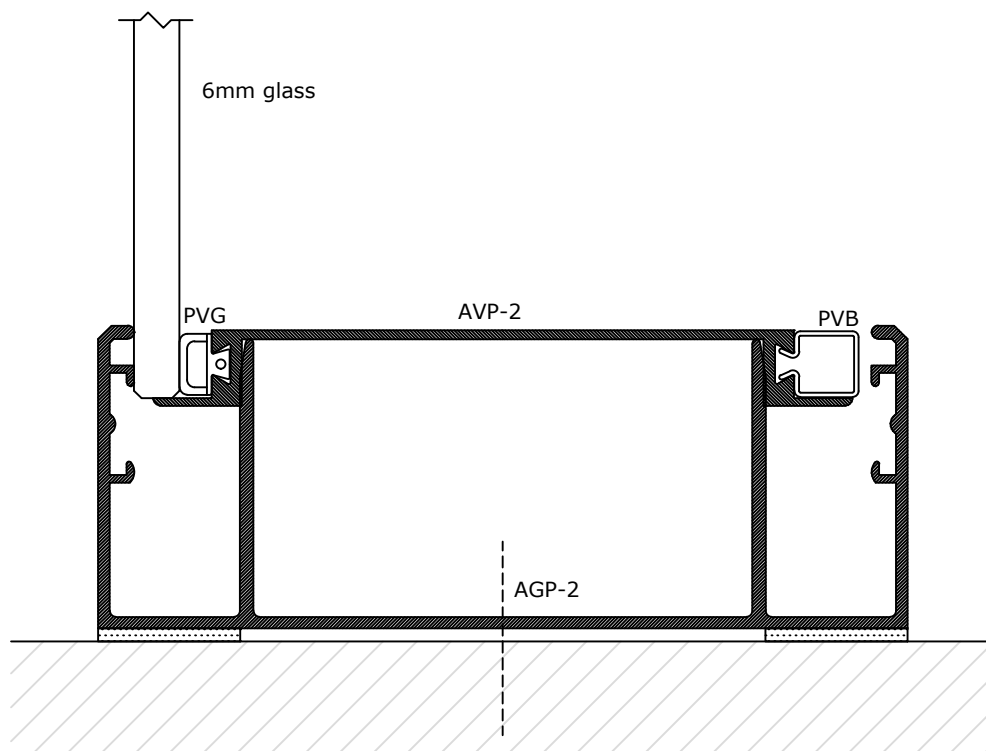

	DEKO Tlf./Tel: +45 43 55 77 11 www.deko.dk / www.deko.com	Projekt/Project: DEKO GV 1090	
	Sags Nr./Case No.: 	Emne/Subject: L3L	Dato/Date:
Mål/Scale: 1:1	 	Revideret/Revision: 2016-10-06-VXX	Signatur Signature EBR