

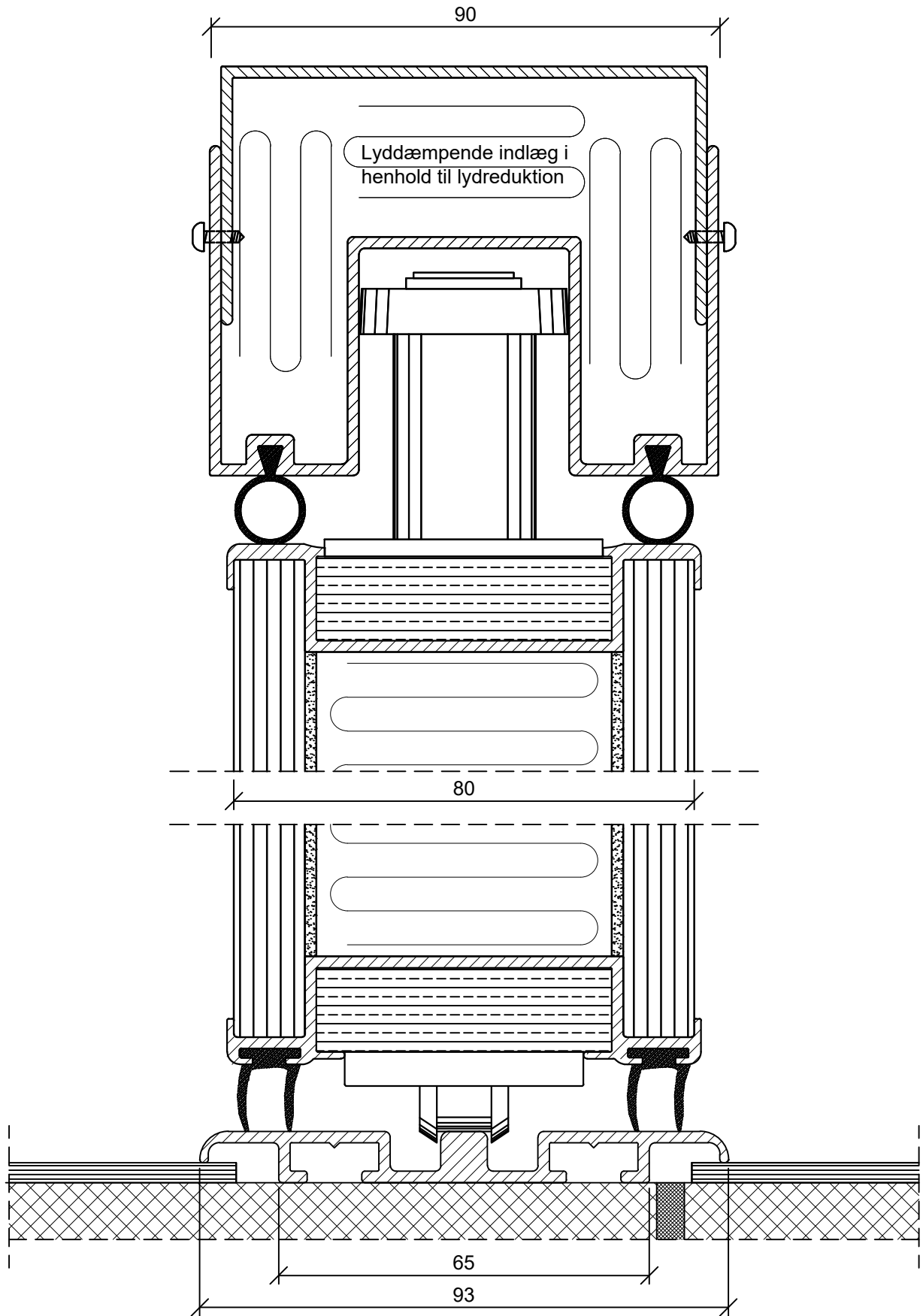

	DEKO Tlf./Tel: +45 43 55 77 11 www.deko.dk / www.deko.com		Projekt/Project: DEKO	
	Sags Nr./Case No.: 2017-05-30-1400	Emne/Subject: DEKO FV 41dB - 52dB Forslag til opbygning over tophængt foldevæg		Dato/Date: 2017-05-30
Mål/Scale: 1:2			Revideret/Revision: 2017-06-02-V01	Signatur Signature



	DEKO Tlf./Tel: +45 43 55 77 11 www.deko.dk / www.deko.com	Projekt/Project: DEKO	
	Sags Nr./Case No.: 2017-05-30-1400	Emne/Subject: DEKO FV 41dB - 52dB Gulvkørende Væg	Dato/Date: 2017-05-30
Mål/Scale: 1:1		Revideret/Revision: 2017-06-02-V01	Signatur Signature

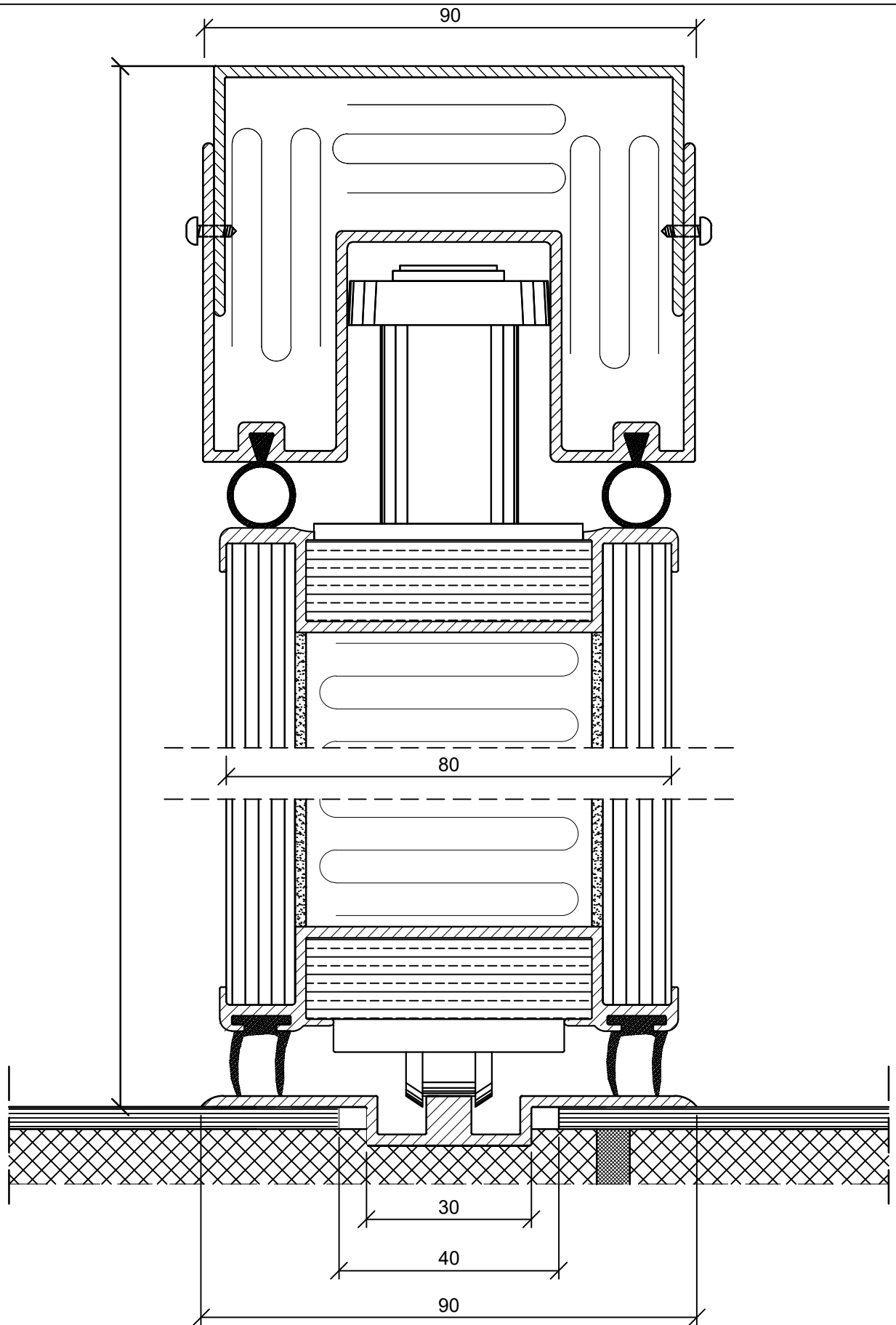

	DEKO Tlf./Tel: +45 43 55 77 11 www.deko.dk / www.deko.com	Projekt/Project: DEKO	
	Sags Nr./Case No.: 2017-05-30-1400	Emne/Subject: DEKO FV 41dB - 52dB Gulvkørende Væg Tilpasset gulvskinne	Dato/Date: 2017-05-30
Mål/Scale: 1:1		Revideret/Revision: 2017-06-02-V01	Signatur Signature

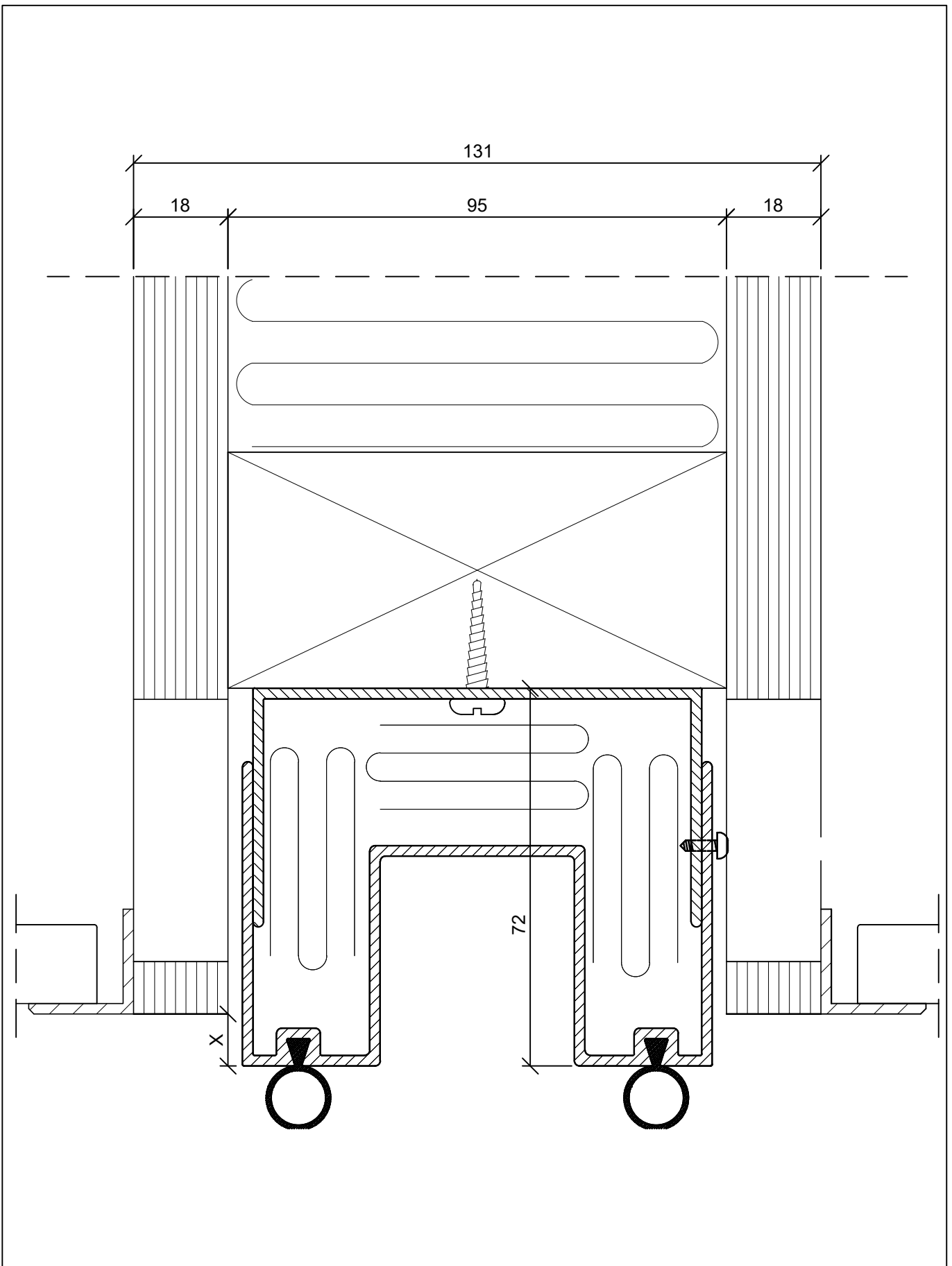

	DEKO Tlf./Tel: +45 43 55 77 11 www.deko.dk / www.deko.com	Projekt/Project: DEKO	
	Sags Nr./Case No.: 2017-05-30-1400	Emne/Subject: DEKO FV 41dB - 52dB Princip af skjult topskinne ved nedhængt loft	Dato/Date: 2017-05-30
Mål/Scale: 1:1		Revideret/Revision: 2017-06-02-V01	Signatur Signature

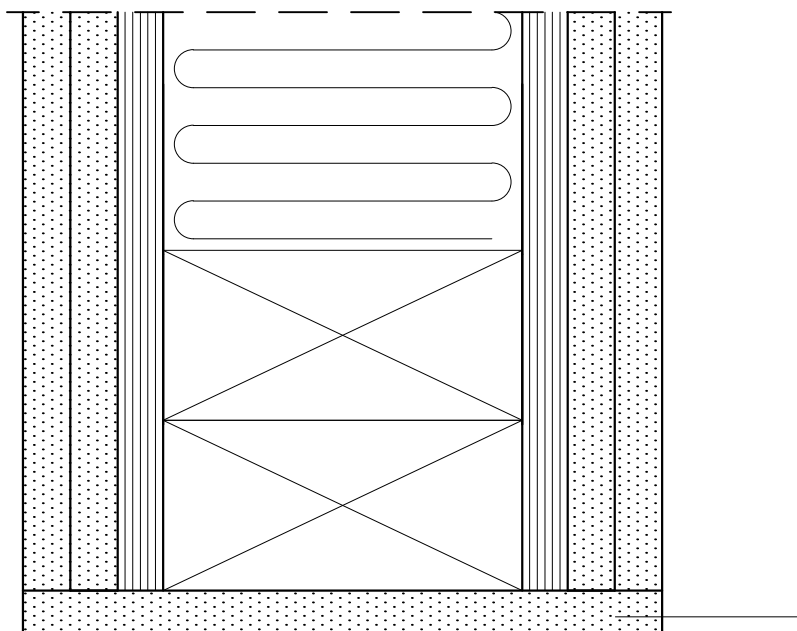
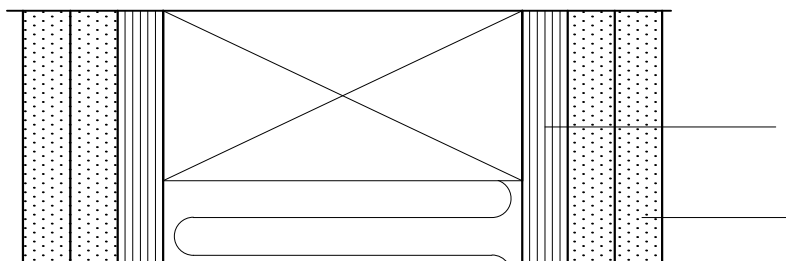

DEKO

Tlf./Tel: +45 43 55 77 11
www.deko.dk / www.deko.com

Projekt/Project:

DEKO

Sags Nr./Case No.:
2017-05-30-1400

Emne/Subject:

DEKO FV 41dB - 52dB
Princip opbygning af skørt over mobil og foldevægge

Dato/Date:
2017-05-30

Tegn. Nr. Sheet No. 1/1

Mål/Scale: 1:2

Revideret/Revision:
2017-06-02-V01

Signatur Signature

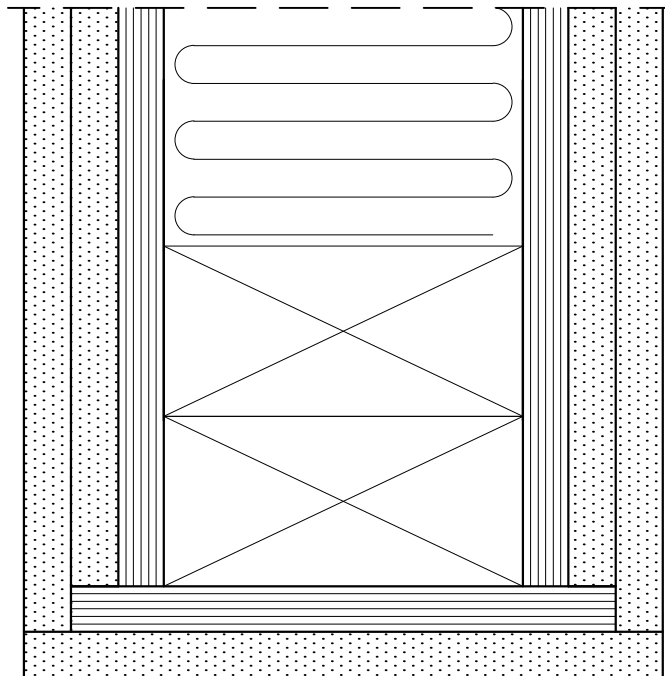
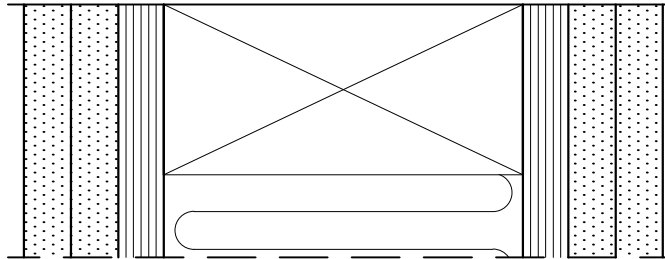

DEKO

Tlf./Tel: +45 43 55 77 11
www.deko.dk / www.deko.com

Projekt/Project:

DEKO

Sags Nr./Case No.:
2017-05-30-1400

Emne/Subject:

DEKO FV 41dB - 52dB
Princip opbygning af skørt over mobil og foldevægge

Dato/Date:
2017-05-30

Tegn. Nr.
Sheet No. 1/1

Mål/Scale: 1:2

Revideret/Revision:
2017-06-02-V01

Signatur
Signature

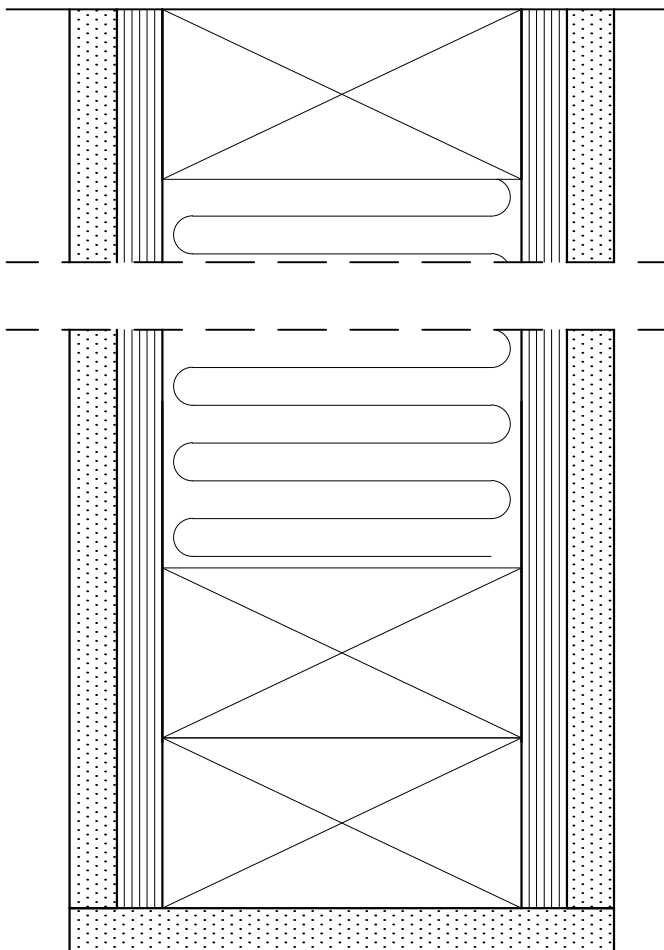

DEKO

Tlf./Tel: +45 43 55 77 11
www.deko.dk / www.deko.com

Projekt/Project:

DEKO

Sags Nr./Case No.:
2017-05-30-1400

Emne/Subject:

DEKO FV 41dB - 52dB
Princip opbygning af skørt over mobil og foldevægge

Dato/Date:
2017-05-30

Tegn. Nr.
Sheet No. 1/1

Mål/Scale: 1:2

Revideret/Revision:
2017-06-02-V01

Signatur
Signature

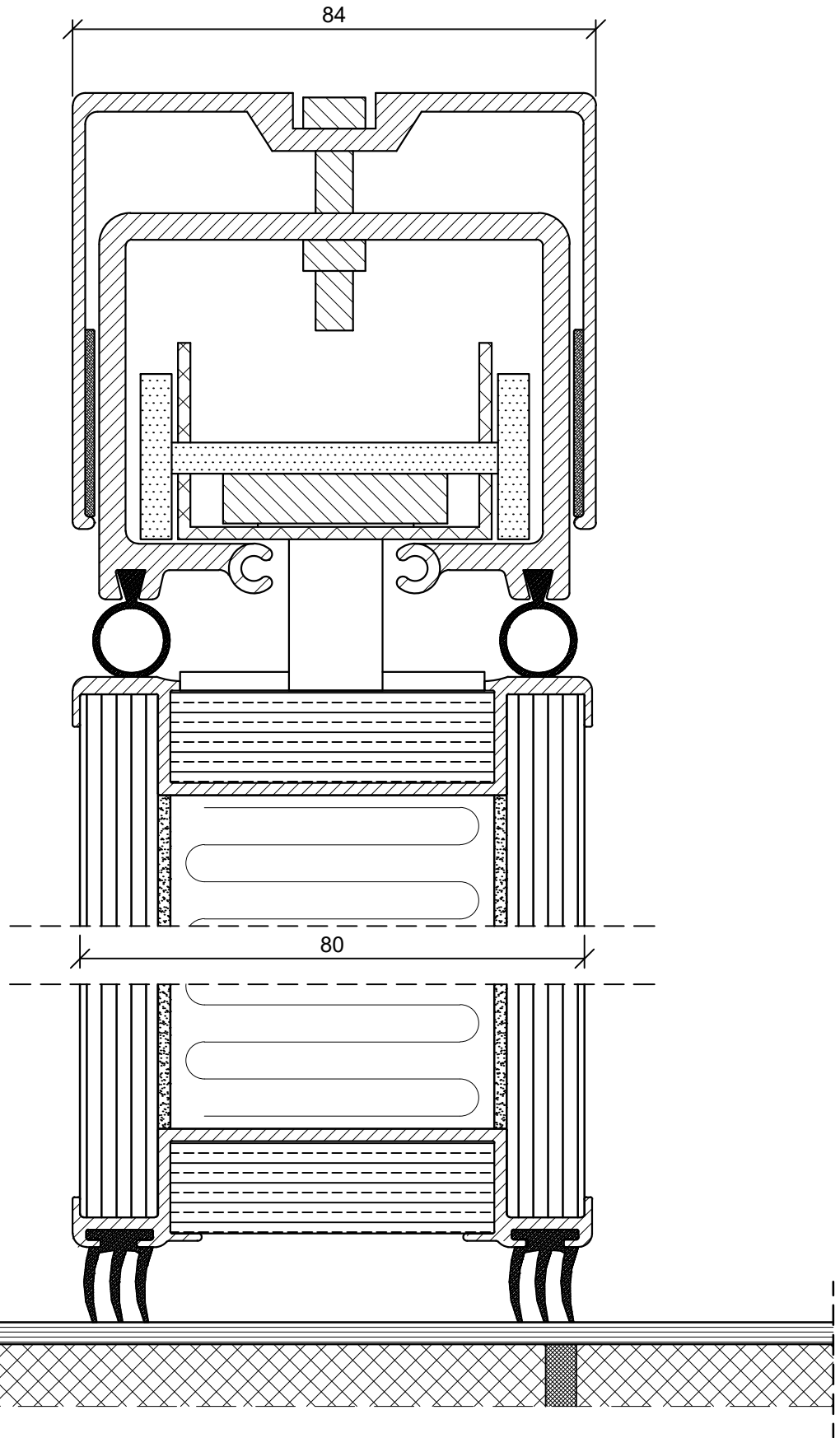

	DEKO Tlf./Tel: +45 43 55 77 11 www.deko.dk / www.deko.com	Projekt/Project: DEKO	
	Sags Nr./Case No.: 2017-05-30-1400	Emne/Subject: DEKO FV 41dB - 52dB Tophængt Væg	Dato/Date: 2017-05-30
Mål/Scale: 1:1		Revideret/Revision: 2017-06-02-V01	Signatur Signature

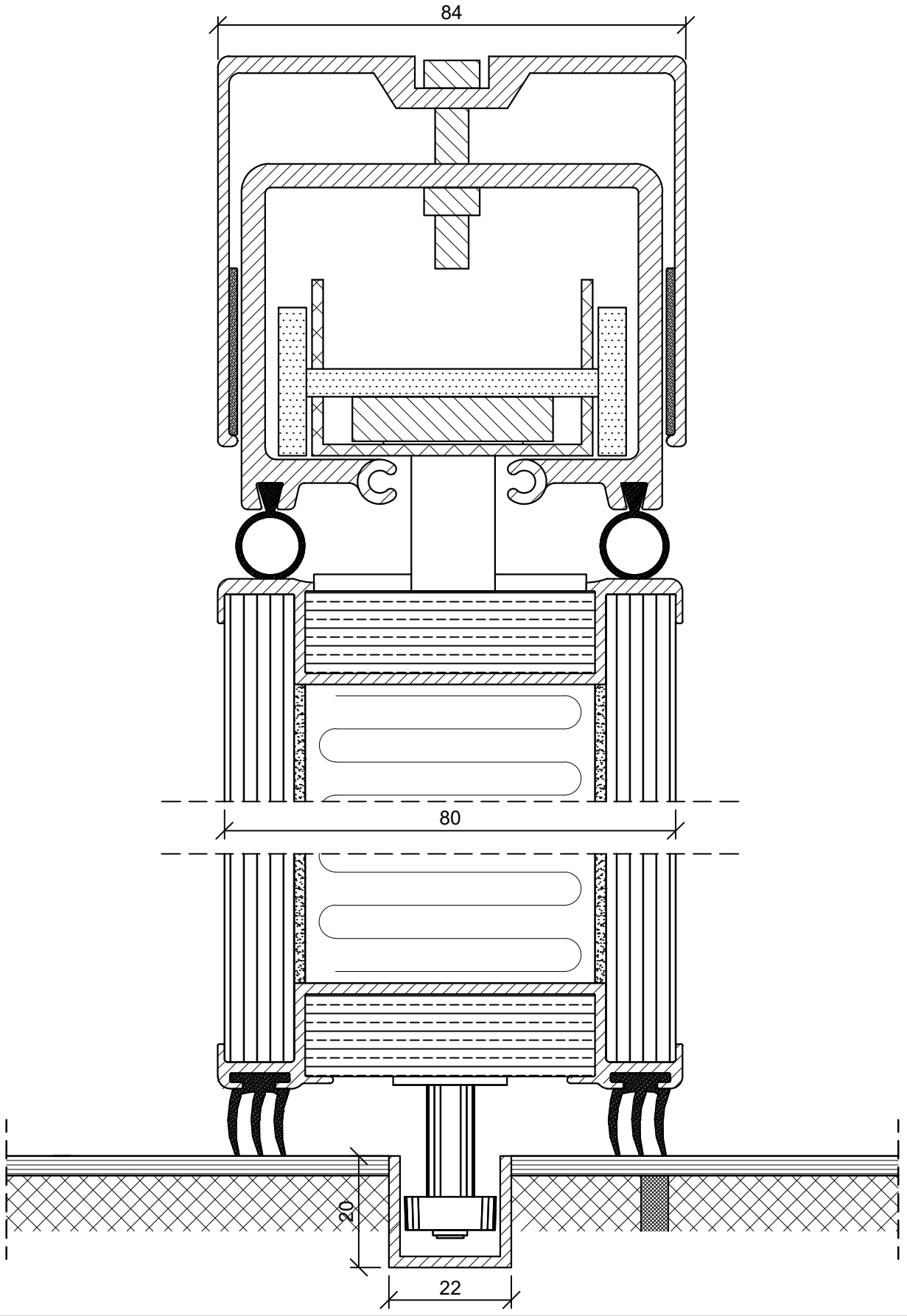

	DEKO Tlf./Tel: +45 43 55 77 11 www.deko.dk / www.deko.com	Projekt/Project: DEKO	
	Sags Nr./Case No.: 2017-05-30-1400	Emne/Subject: DEKO FV 41dB - 52dB Tophængt Væg m.gulvstyr	Dato/Date: 2017-05-30
Mål/Scale: 1:1		Revideret/Revision: 2017-06-02-V01	Signatur Signature