

|   |  |  |                                 |
|---|--|--|---------------------------------|
|  | <b>DEKO</b><br>Tlf./Tel: +45 43 55 77 11<br>www.deko.dk / www.deko.com | <b>Projekt/Project:</b><br>DEKO                              |                                 |
|   | <b>Sags Nr./Case No.:</b><br>2017-05-30-1400                           | <b>Emne/Subject:</b><br>DEKO MV<br>Åben Topskinne Vægopstalt | <b>Dato/Date:</b><br>2017-05-30 |
| <b>Mål/Scale:</b> 1:1   |  | <b>Revideret/Revision:</b><br>2017-06-02-V01                 | <b>Signatur Signature</b>       |

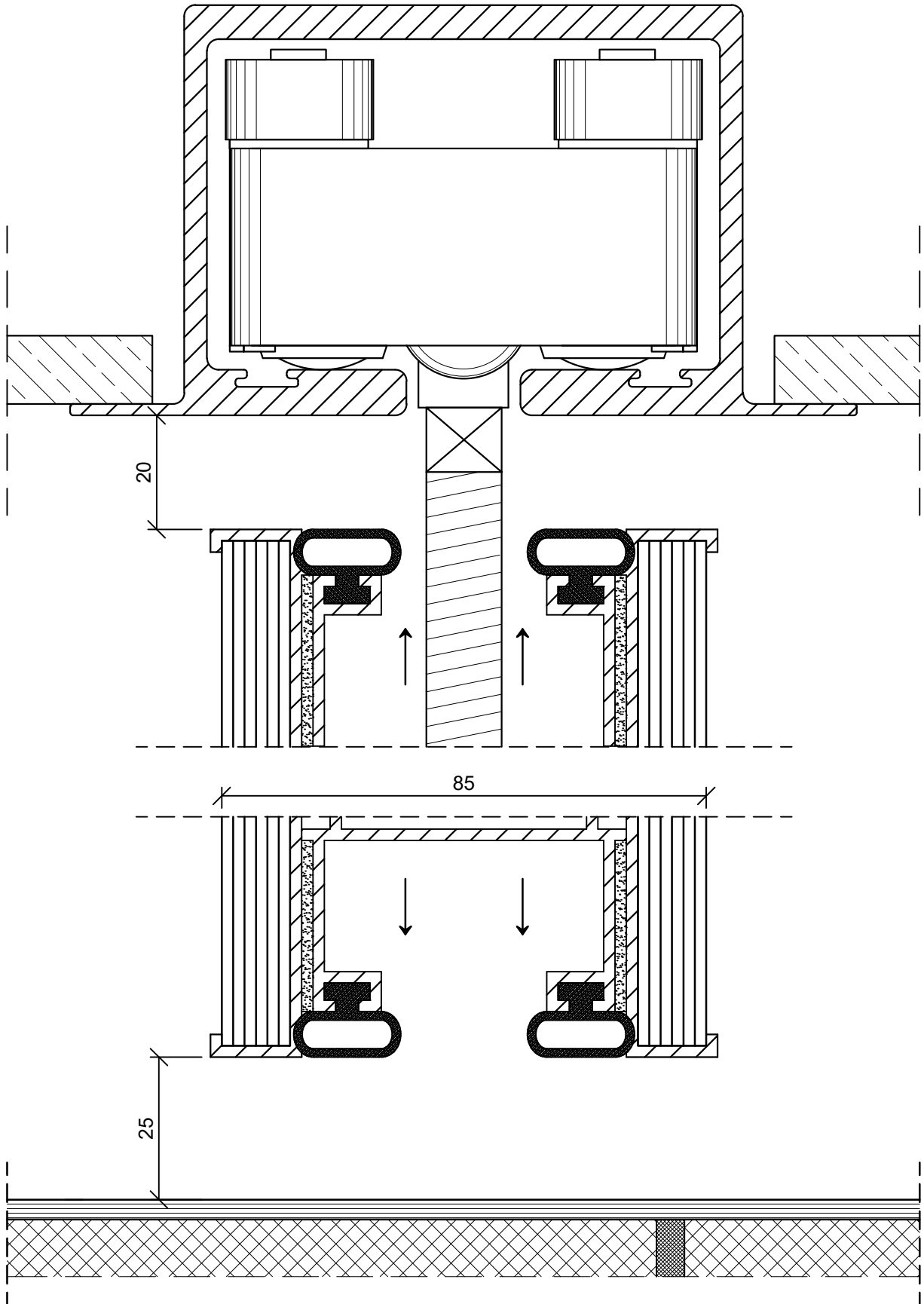

|   |  |  |                                 |                                |
|---|--|--|---------------------------------|--------------------------------|
|  | <b>DEKO</b><br>Tlf./Tel: +45 43 55 77 11<br>www.deko.dk / www.deko.com |  | <b>Projekt/Project:</b><br>DEKO |                                |
|   | <b>Sags Nr./Case No.:</b><br>2017-05-30-1400                           |  | <b>Dato/Date:</b><br>2017-05-30 |                                |
| <b>Mål/Scale:</b> 1:1   |  | <b>Emne/Subject:</b><br>DEKO MV<br>Åben Topskinn Vægopstalt Vinger |                                 | <b>Tegn. Nr. Sheet No.</b> 1/1 |
|   |  | <b>Revideret/Revision:</b><br>2017-06-02-V01                       |                                 | <b>Signatur Signature</b>      |

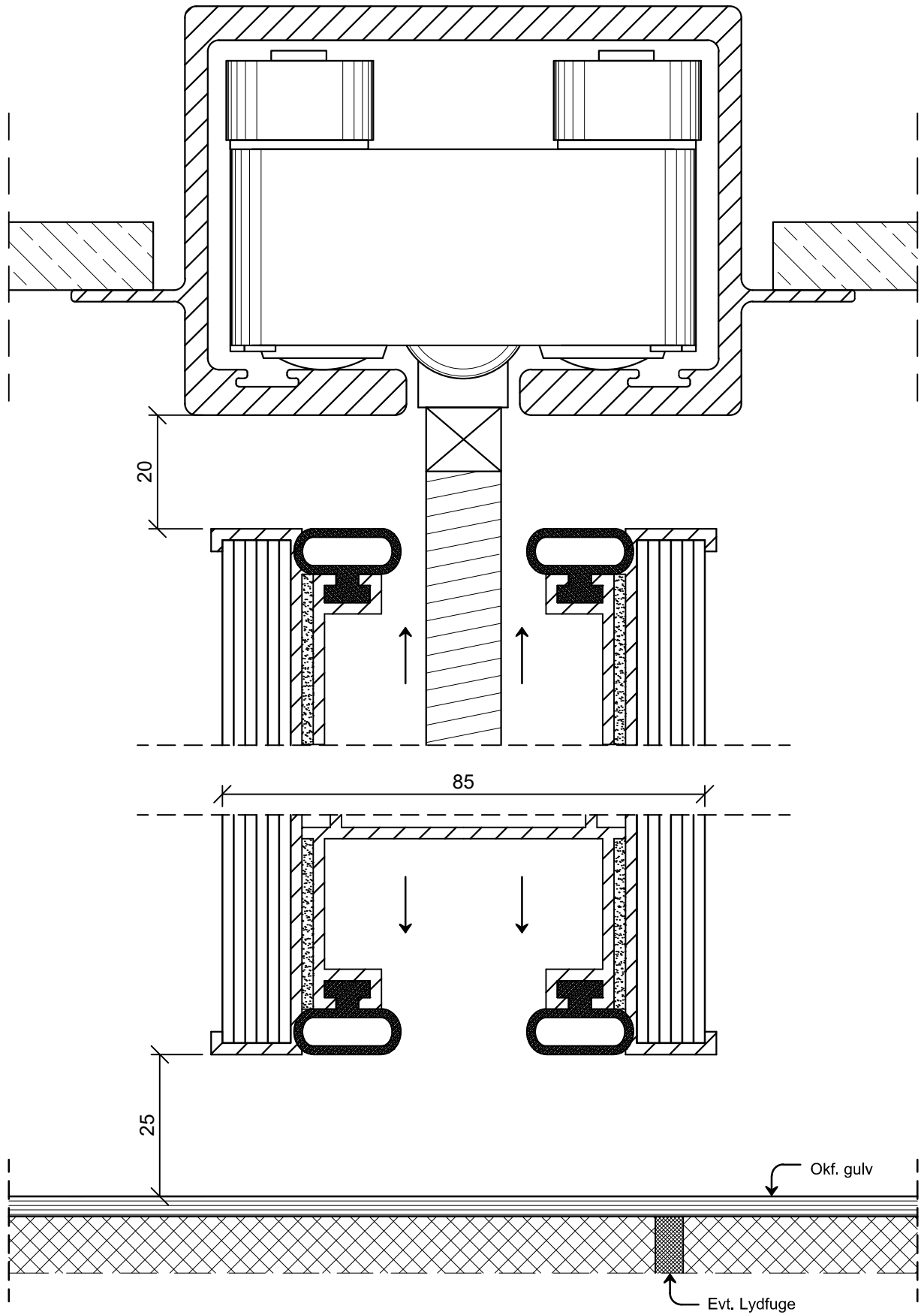

**DEKO**

Tlf./Tel: +45 43 55 77 11  
 www.deko.dk / www.deko.com

**Projekt/Project:**

DEKO

**Sags Nr./Case No.:**  
 2017-05-30-1400

**Emne/Subject:**

DEKO MV  
 Åben Topskinn Vægopstalt Vinger

**Dato/Date:**  
 2017-05-30

**Tegn. Nr. / Sheet No.** 1/1

**Mål/Scale:** 1:1

**Revideret/Revision:**  
 2017-06-05-V01

**Signatur / Signature**

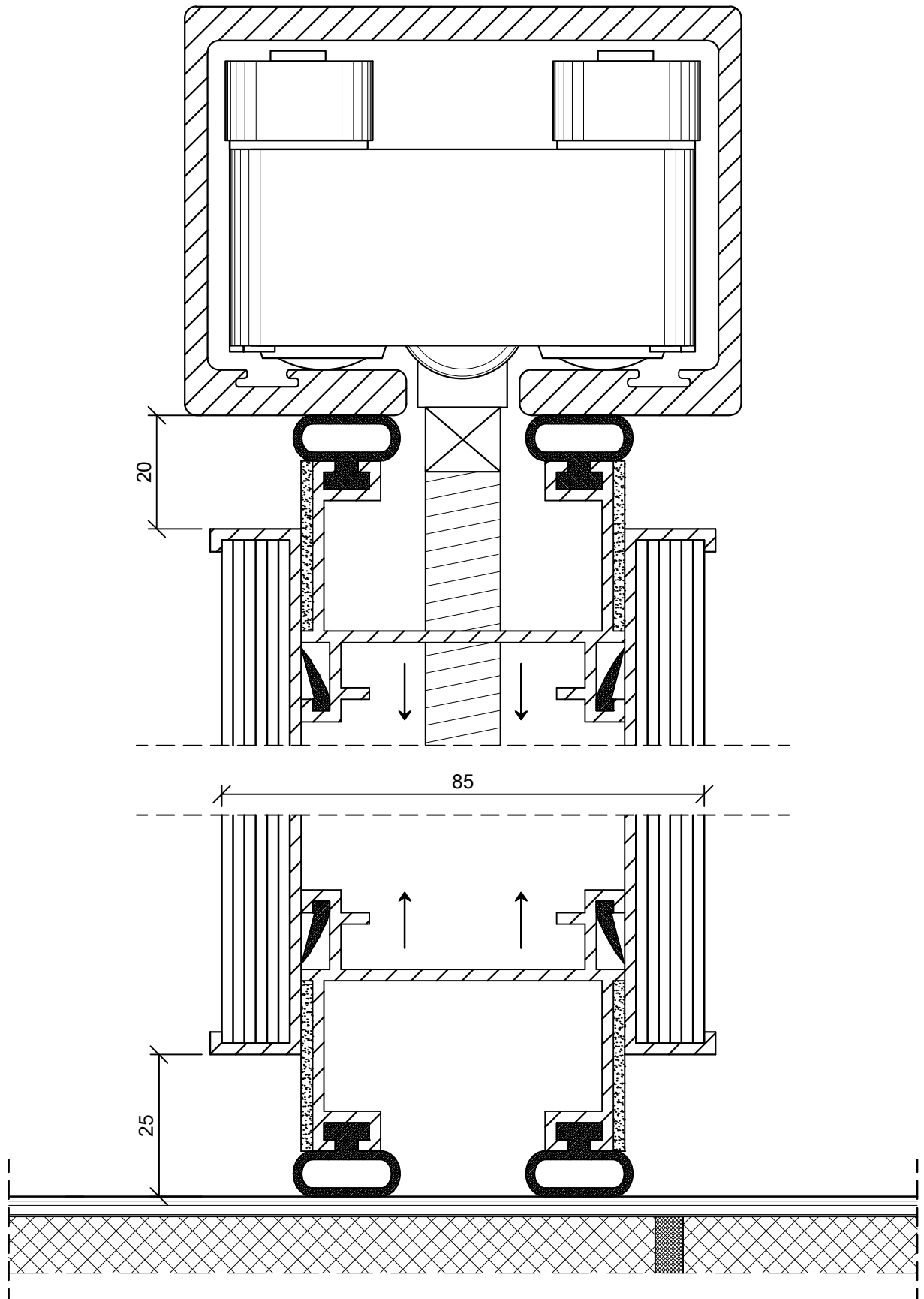

|   |  |  |                                 |
|---|--|--|---------------------------------|
|  | <b>DEKO</b><br>Tlf./Tel: +45 43 55 77 11<br>www.deko.dk / www.deko.com | <b>Projekt/Project:</b><br>DEKO                              |                                 |
|   | <b>Sags Nr./Case No.:</b><br>2017-05-30-1400                           | <b>Emne/Subject:</b><br>DEKO MV<br>ben Topskinne Vgopstalt | <b>Dato/Date:</b><br>2017-05-30 |
| <b>Ml/Scale:</b> 1:1   |  | <b>Revideret/Revision:</b><br>2017-06-05-V01                 | <b>Signatur Signature</b>       |

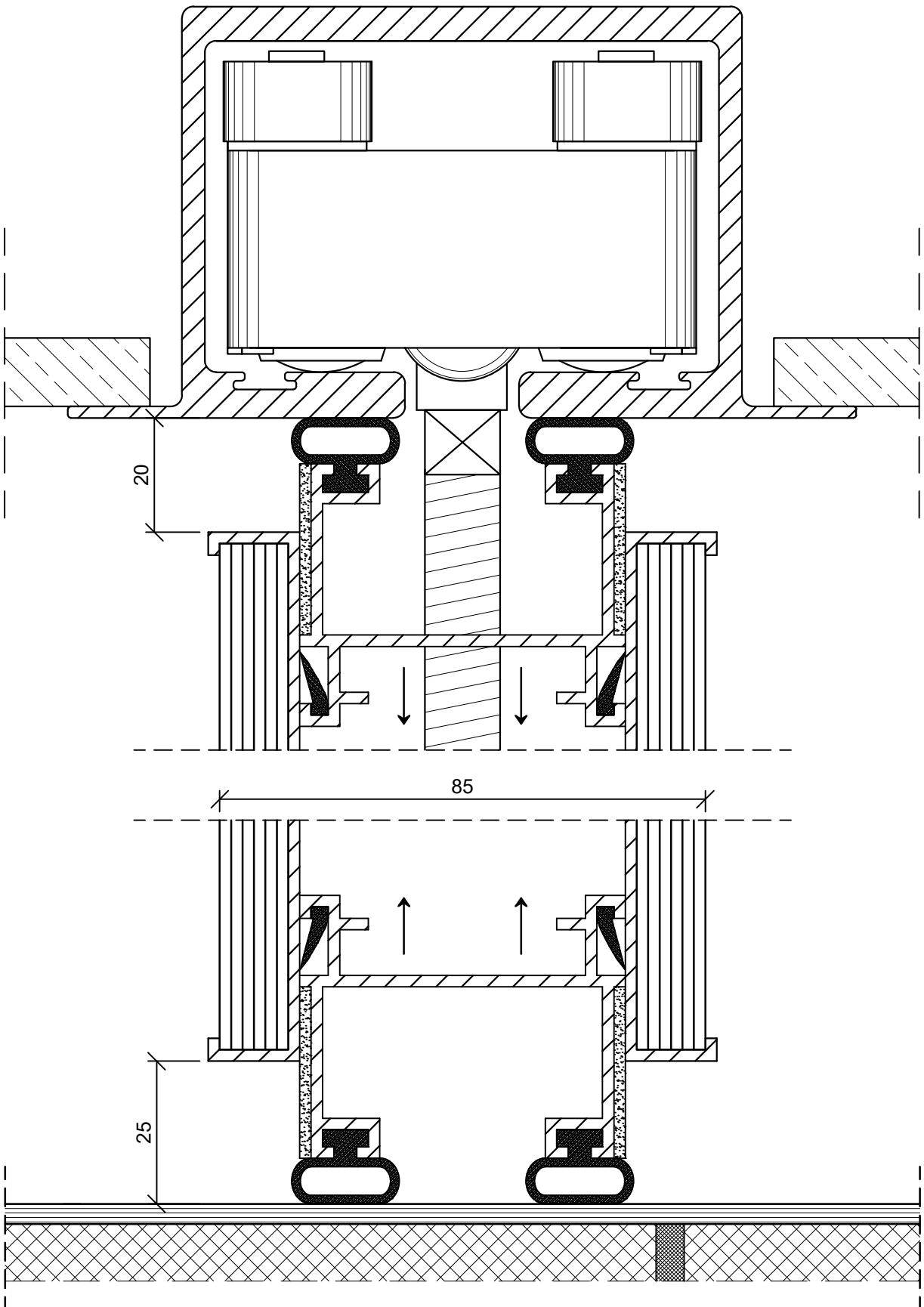

|   |  |   |                                 |
|---|--|---|---------------------------------|
|  | <b>DEKO</b><br>Tlf./Tel: +45 43 55 77 11<br>www.deko.dk / www.deko.com | <b>Projekt/Project:</b><br>DEKO                                     |                                 |
|   | <b>Sags Nr./Case No.:</b><br>2017-05-30-1400                           | <b>Emne/Subject:</b><br>DEKO MV<br> ben Topskinne Vægopstalt Vinger | <b>Dato/Date:</b><br>2017-05-30 |
| <b>M l/Scale:</b> 1:1   |  | <b>Revideret/Revision:</b><br>2017-06-05-V01                        | <b>Signatur Signature</b>       |

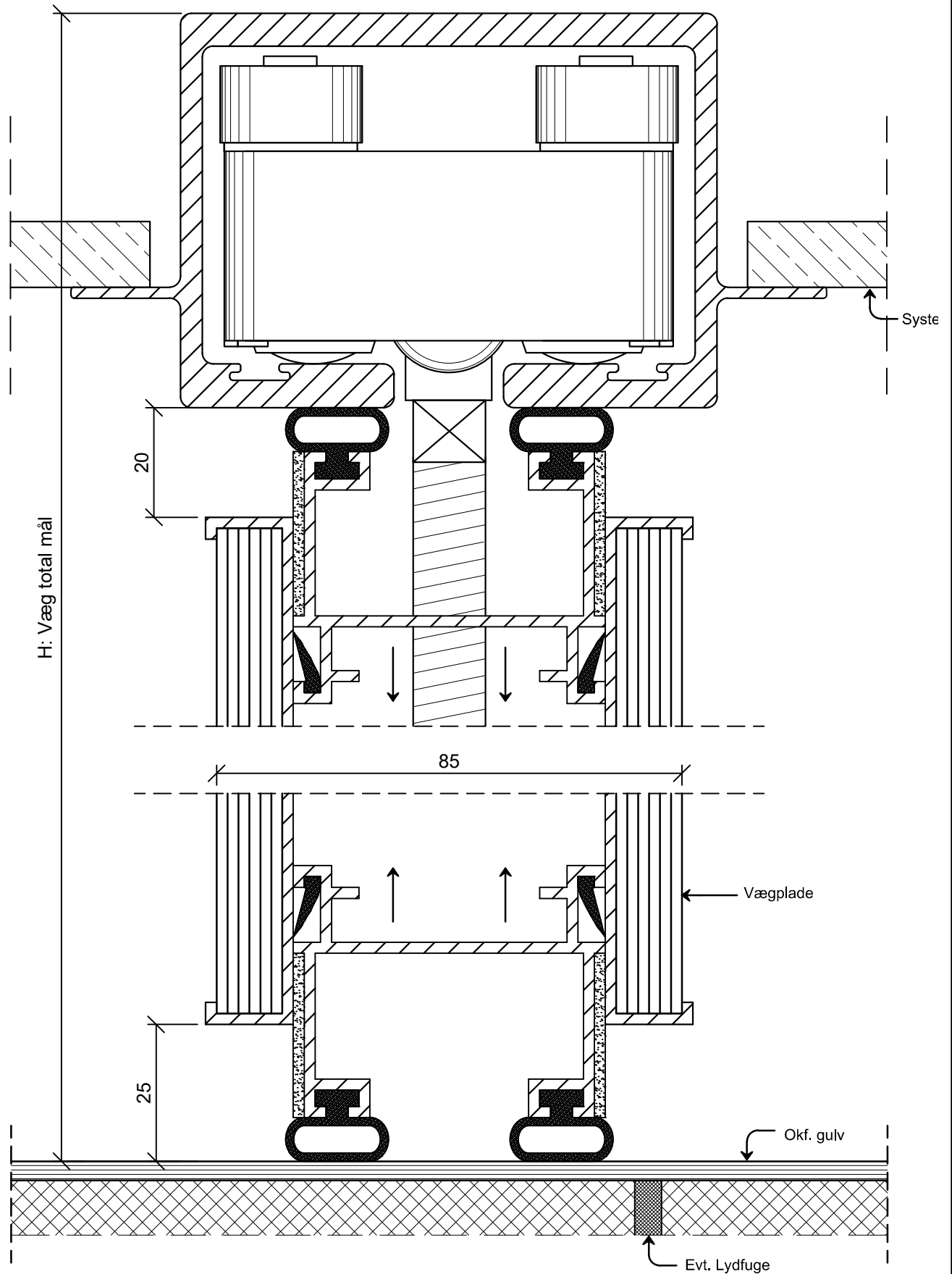

|   |  |   |                                 |
|---|--|---|---------------------------------|
|  | <b>DEKO</b><br>Tlf./Tel: +45 43 55 77 11<br>www.deko.dk / www.deko.com | <b>Projekt/Project:</b><br>DEKO                                     |                                 |
|   | <b>Sags Nr./Case No.:</b><br>2017-05-30-1400                           | <b>Emne/Subject:</b><br>DEKO MV<br>Åben Topskinne Vægopstalt Vinger | <b>Dato/Date:</b><br>2017-05-30 |
| <b>Mål/Scale:</b> 1:1   |  | <b>Revideret/Revision:</b><br>2017-06-05-V01                        | <b>Signatur Signature</b>       |

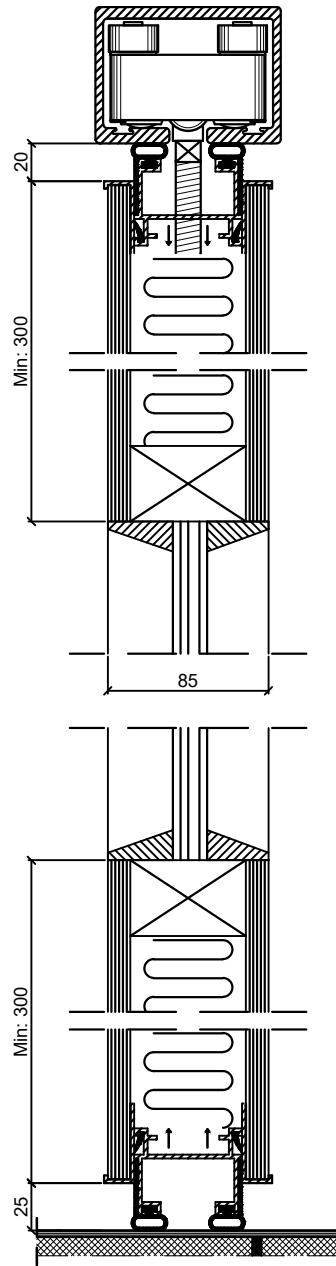

**DEKO**

Tlf./Tel: +45 43 55 77 11  
 www.deko.dk / www.deko.com

**Projekt/Project:**

DEKO

**Sags Nr./Case No.:**  
 2017-05-30-1400

**Emne/Subject:**

DEKO MV  
 Lodret Snit i Glasmobilvæg

**Dato/Date:**  
 2017-05-30

**Tegn. Nr. / Sheet No.** 1/1

**Mål/Scale:** 1:4

**Revideret/Revision:**  
 2017-06-05-V01

**Signatur / Signature**

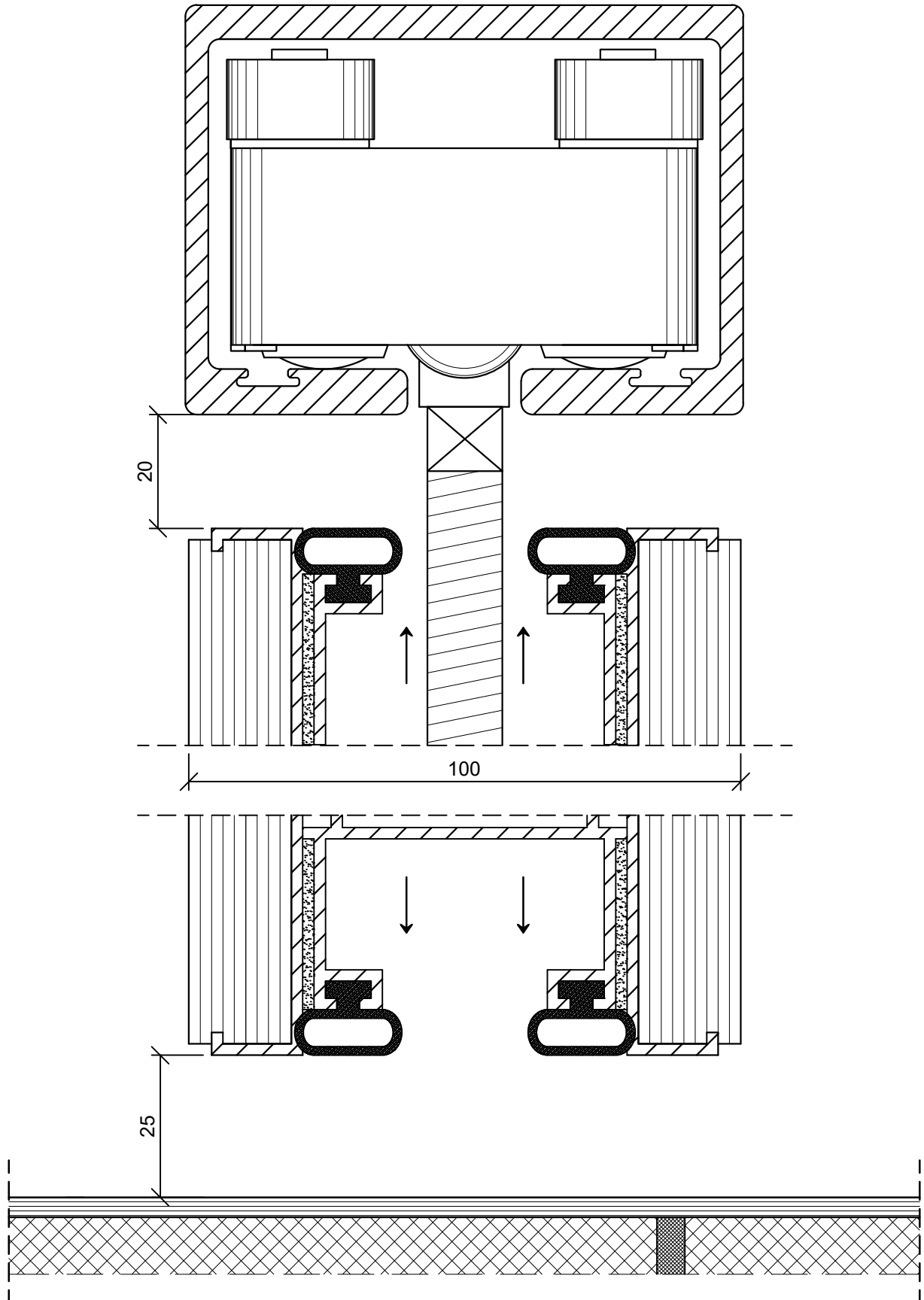

|   |  |  |                                 |
|---|--|--|---------------------------------|
|  | <b>DEKO</b><br>Tlf./Tel: +45 43 55 77 11<br>www.deko.dk / www.deko.com | <b>Projekt/Project:</b><br>DEKO                              |                                 |
|   | <b>Sags Nr./Case No.:</b><br>2017-05-30-1400                           | <b>Emne/Subject:</b><br>DEKO MV<br>Åben Topskinne Vægopstalt | <b>Dato/Date:</b><br>2017-05-30 |
| <b>Mål/Scale:</b> 1:1   |  | <b>Revideret/Revision:</b><br>2017-06-05-V01                 | <b>Signatur Signature</b>       |



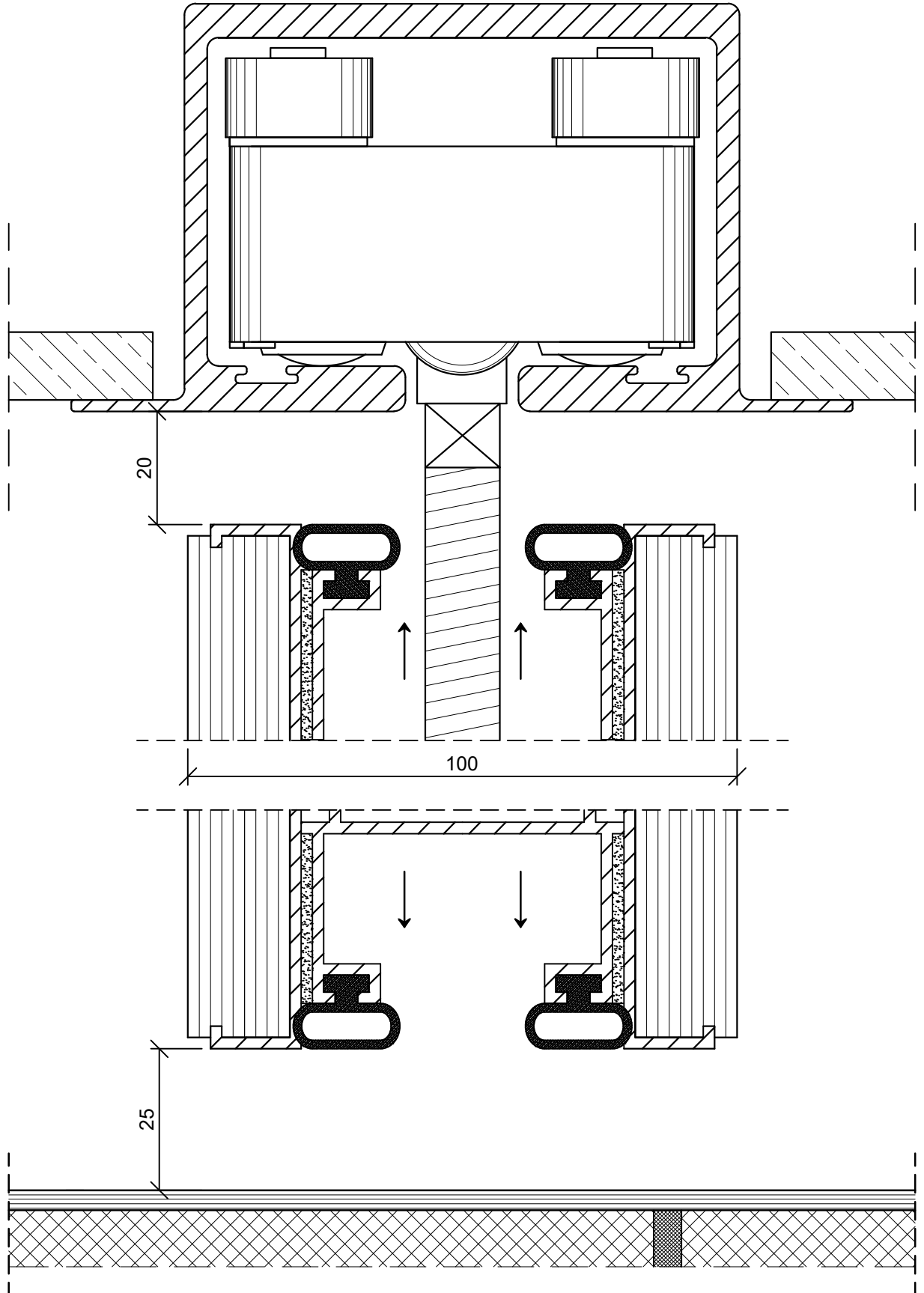

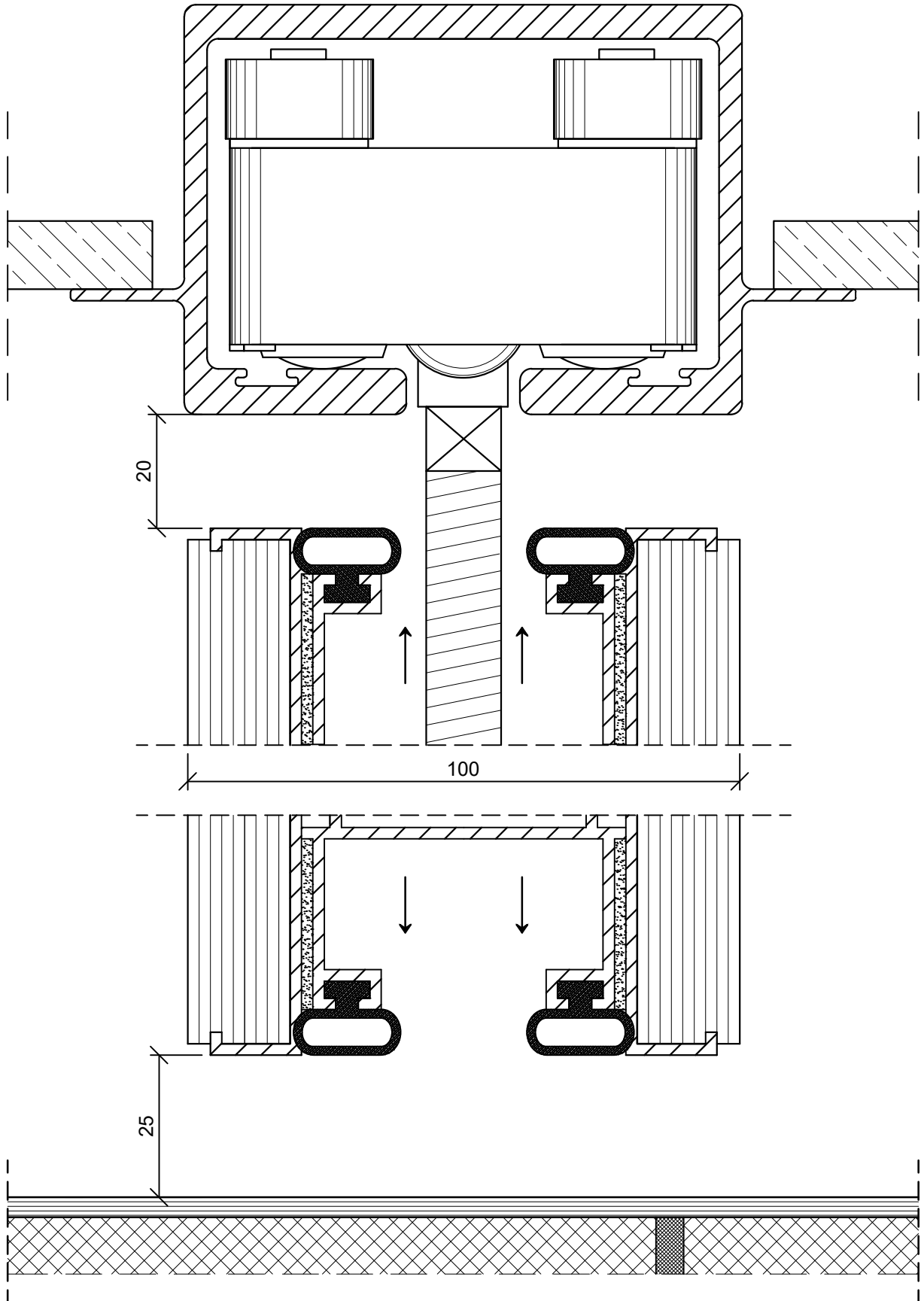

|   |  |   |                                 |
|---|--|---|---------------------------------|
|  | <b>DEKO</b><br>Tlf./Tel: +45 43 55 77 11<br>www.deko.dk / www.deko.com | <b>Projekt/Project:</b><br>DEKO                                     |                                 |
|   | <b>Sags Nr./Case No.:</b><br>2017-05-30-1400                           | <b>Emne/Subject:</b><br>DEKO MV<br>Åben Topskinne Vægopstalt Vinger | <b>Dato/Date:</b><br>2017-05-30 |
| <b>Mål/Scale:</b> 1:1   |  | <b>Revideret/Revision:</b><br>2017-06-05-V01                        | <b>Signatur Signature</b>       |

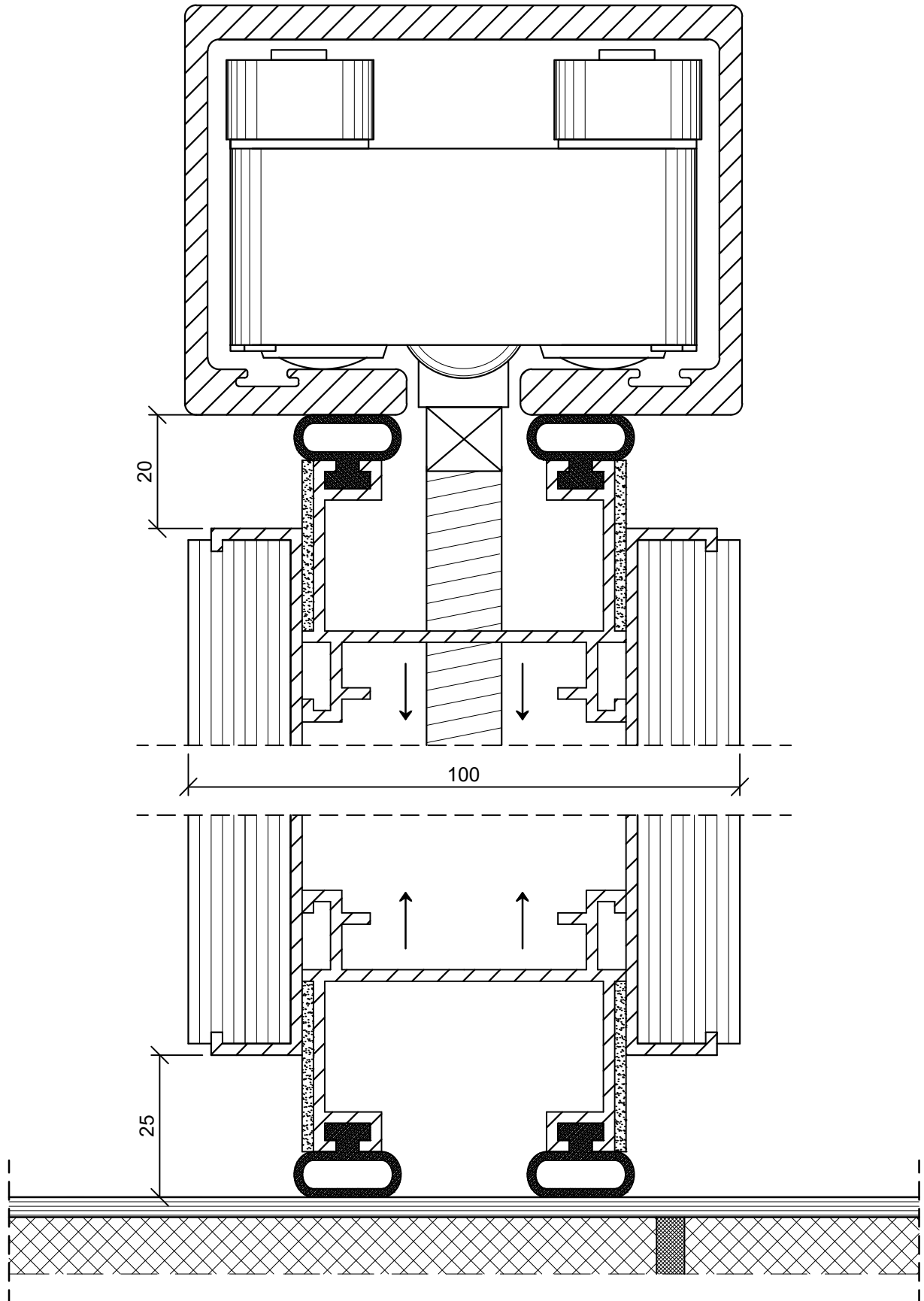

|   |  |   |                                 |
|---|--|---|---------------------------------|
|  | <b>DEKO</b><br>Tlf./Tel: +45 43 55 77 11<br>www.deko.dk / www.deko.com | <b>Projekt/Project:</b><br>DEKO                                     |                                 |
|   | <b>Sags Nr./Case No.:</b><br>2017-05-30-1400                           | <b>Emne/Subject:</b><br>DEKO MV<br>Åben Topskinne Vægopstalt Vinger | <b>Dato/Date:</b><br>2017-05-30 |
| <b>Mål/Scale:</b> 1:1   |  | <b>Revideret/Revision:</b><br>2017-06-05-V01                        | <b>Signatur Signature</b>       |



|   |  |  |                                 |
|---|--|--|---------------------------------|
|  | <b>DEKO</b><br>Tlf./Tel: +45 43 55 77 11<br>www.deko.dk / www.deko.com | <b>Projekt/Project:</b><br>DEKO                                  |                                 |
|   | <b>Sags Nr./Case No.:</b><br>2017-05-30-1400                           | <b>Emne/Subject:</b><br>DEKO MV<br>Fastlåst Topskinne Vægopstalt | <b>Dato/Date:</b><br>2017-05-30 |
| <b>Mål/Scale:</b> 1:1   |  | <b>Revideret/Revision:</b><br>2017-06-05-V01                     | <b>Signatur Signature</b>       |

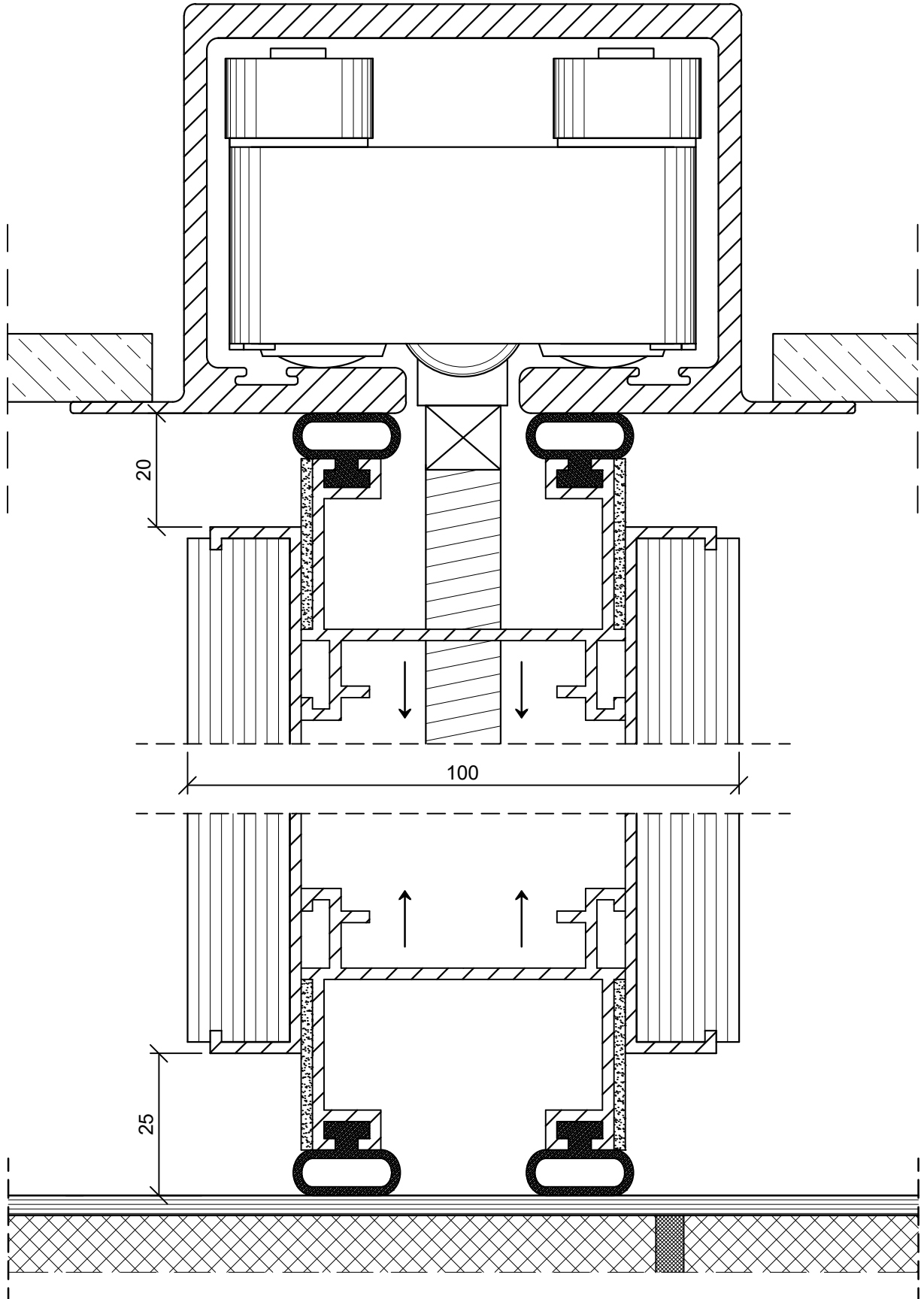

**DEKO**

Tlf./Tel: +45 43 55 77 11  
 www.deko.dk / www.deko.com

**Projekt/Project:**

DEKO

**Sags Nr./Case No.:**  
 2017-05-30-1400

**Emne/Subject:**

DEKO MV  
 Fastlåst Topskinne Vægopstalt Vinger

**Dato/Date:**  
 2017-05-30

**Tegn. Nr. Sheet No.** 1/1

**Mål/Scale:** 1:1

**Revideret/Revision:**  
 2017-06-05-V01

**Signatur Signature**