

DEKO

Tlf./Tel: +45 43 55 77 11
www.deko.dk / www.deko.com

Projekt/Project:

DEKO FG

Sags Nr./Case No.:

Emne/Subject:

Lofttilslutning

L1A

Dato/Date:

Tegn. Nr.

Sheet No. 1/1

Mål/Scale

1:1

Revideret/Revision:

2016-05-03-V01

Signatur

Signature OP/EZ

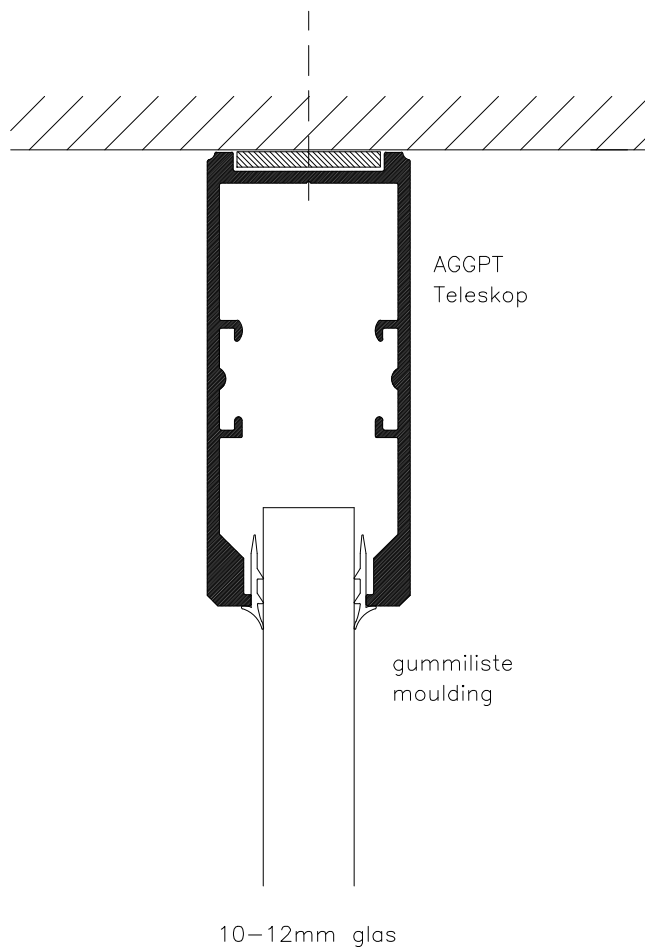

	DEKO	Projekt/Project:	
	Tlf./Tel: +45 43 55 77 11 www.deko.dk / www.deko.com	DEKO FG	
Sags Nr./Case No.:	Emne/Subject:	Dato/Date:	Tegn. Nr. Sheet No. 1/1
Mål/Scale 1:1	L1B	Revideret/Revision: 2016-05-03-V01	Signatur Signature OP/EZ

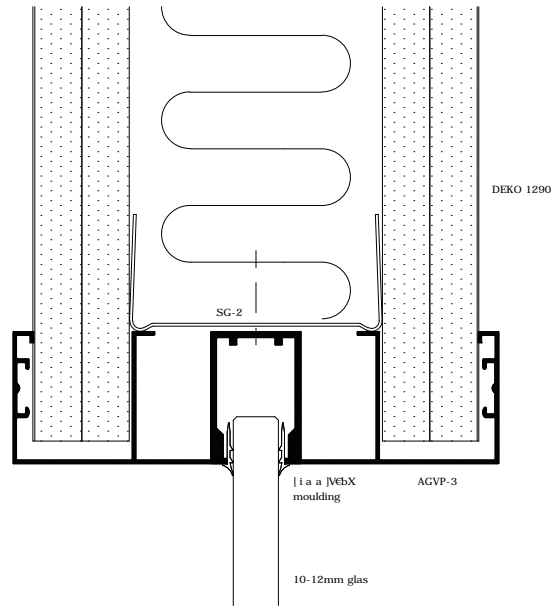

	DEKO Tlf./Tel: +45 43 55 77 11 www.deko.dk / www.deko.com		Projekt/Project: DEKO FG	
	Sags Nr./Case No.:	Emne/Subject: Lofttilslutning L1E		Dato/Date:
Mål/Scale 1:2			Revideret/Revision: 2016-05-03-V01	Signatur Signature OP/EZ

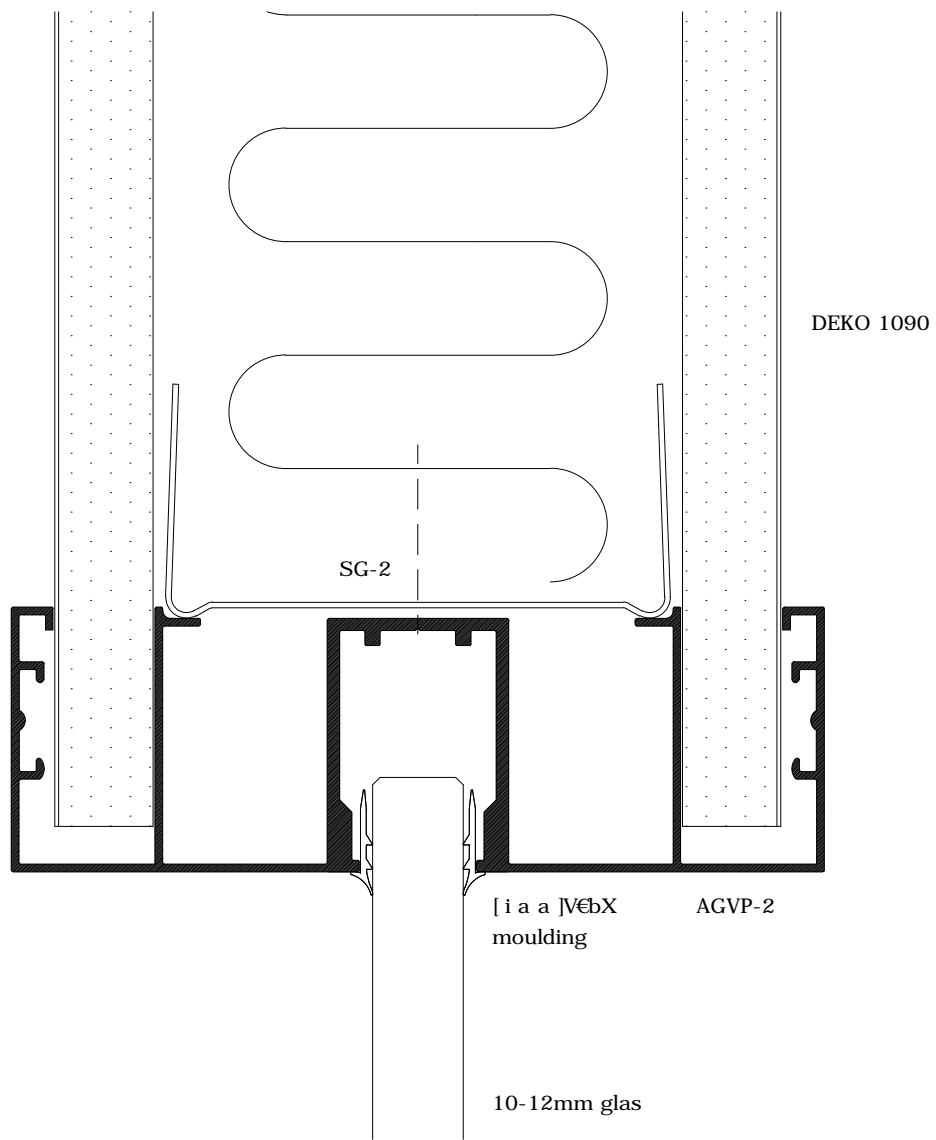

DEKO
 Tlf./Tel: +45 43 55 77 11
 www.deko.dk / www.deko.com

Projekt/Project:
 DEKO FG

Sags Nr./Case No.:

Emne/Subject:
 Lofttilslutning
 L1F

Dato/Date:

Tegn. Nr. Sheet No. 1/1

Mål/Scale
 1:1

Revideret/Revision:
 2016-05-03-V01

Signatur Signature OP/EZ

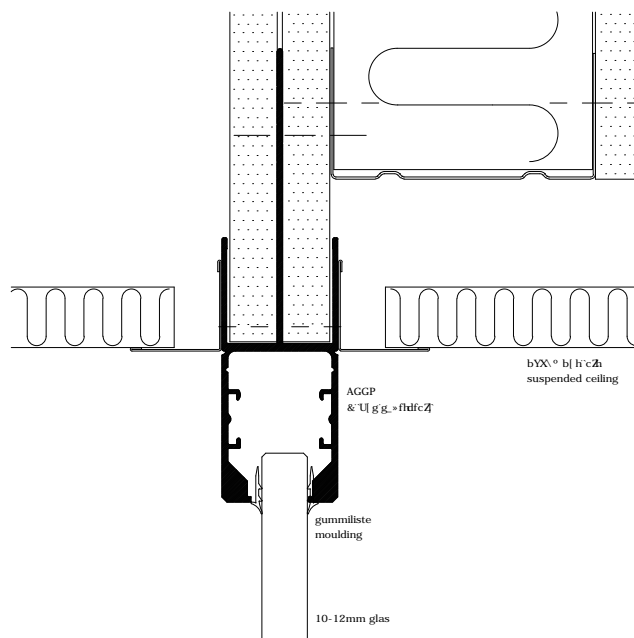

	DEKO Tlf./Tel: +45 43 55 77 11 www.deko.dk / www.deko.com		Projekt/Project: DEKO FG	
	Sags Nr./Case No.:	Emne/Subject: Lofttilslutning LIG		Dato/Date:
Mål/Scale 1:2			Revideret/Revision: 2016-05-03-V01	Signatur Signature OP/EZ

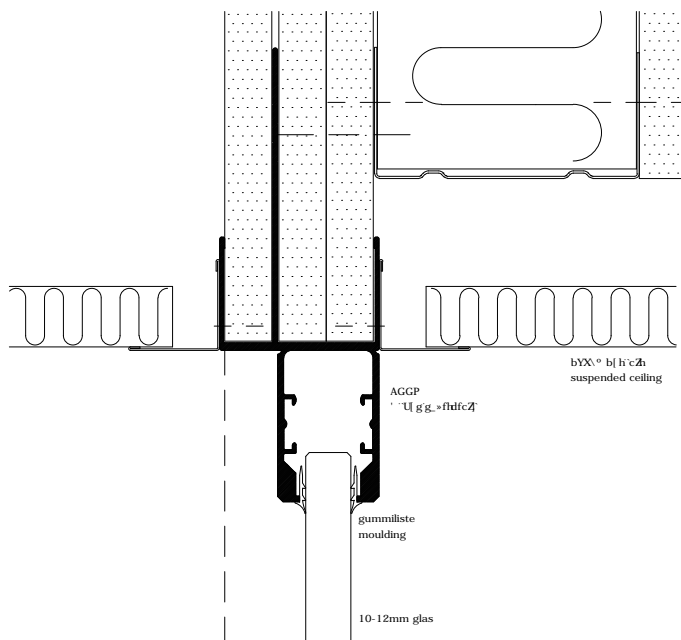

	DEKO Tlf./Tel: +45 43 55 77 11 www.deko.dk / www.deko.com		Projekt/Project: DEKO FG	
	Sags Nr./Case No.:	Emne/Subject: Lofttilslutning L1H		Dato/Date:
Mål/Scale 1:2			Revideret/Revision: 2016-05-03-V01	Signatur Signature OP/EZ