

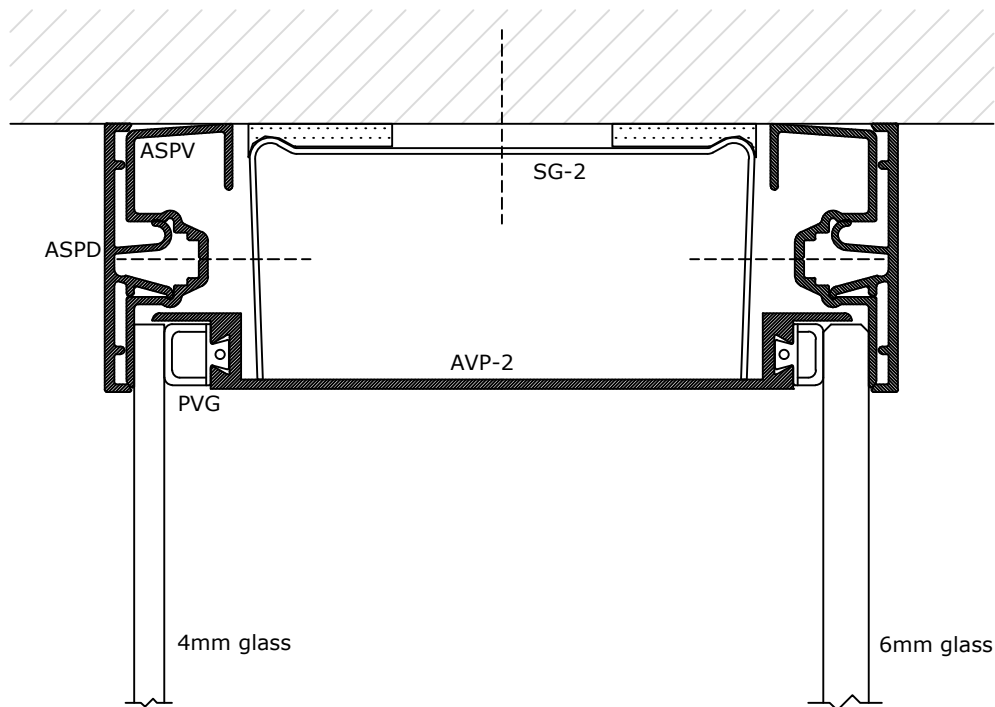

	DEKO Tlf./Tel: +45 43 55 77 11 www.deko.dk / www.deko.com	Projekt/Project: DEKO GV 1090	
	Sags Nr./Case No.:	Emne/Subject: L1E	Dato/Date:
Mål/Scale: 1:1		Revideret/Revision: 2016-10-06-VXX	Signatur Signature EBR



	DEKO Tlf./Tel: +45 43 55 77 11 www.deko.dk / www.deko.com	Projekt/Project: DEKO GV 1090	
	Sags Nr./Case No.:	Emne/Subject: L1G	Dato/Date:
Mål/Scale: 1:1		Revideret/Revision: 2016-10-06-VXX	Signatur Signature EBR

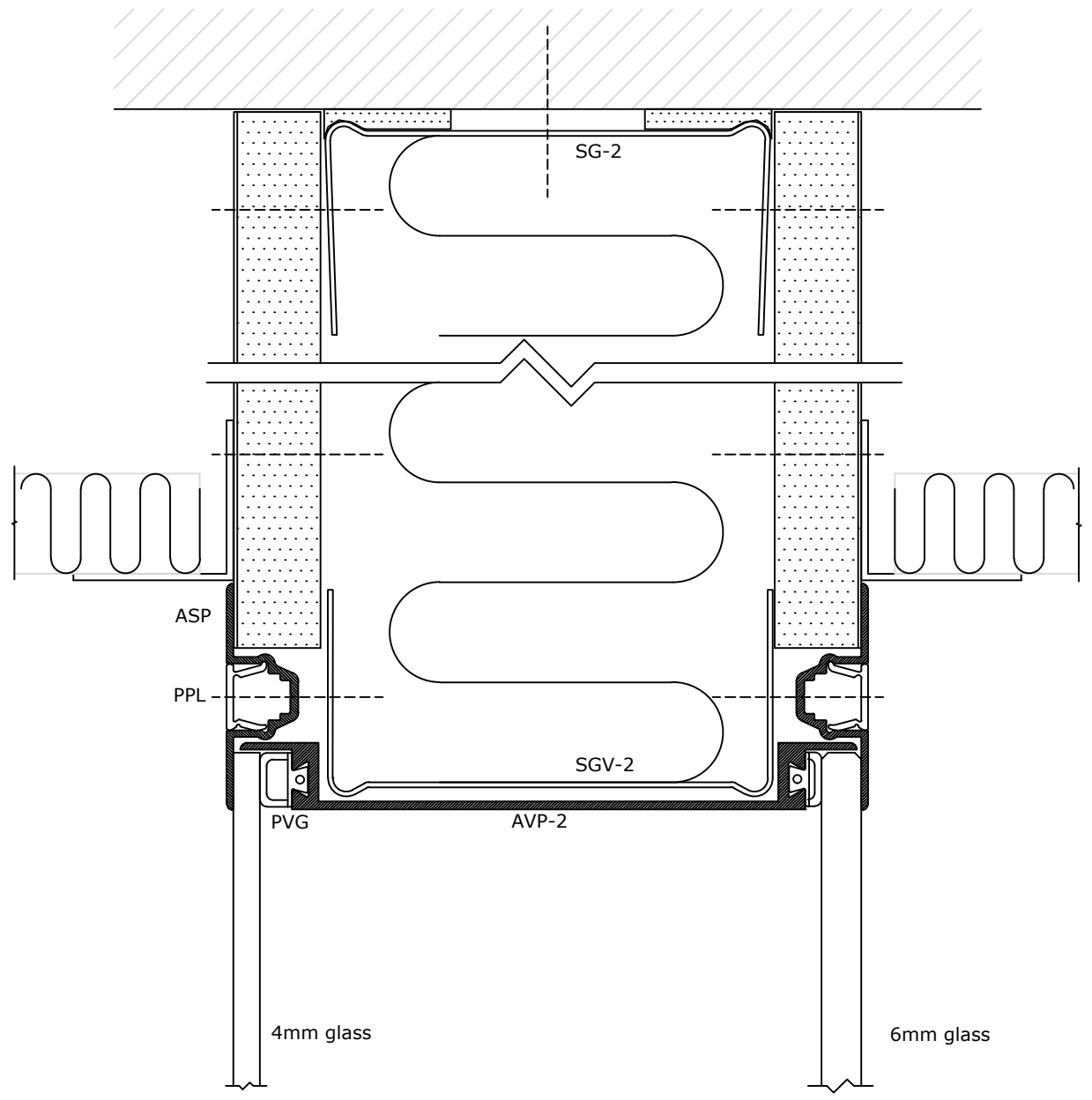

	DEKO Tlf./Tel: +45 43 55 77 11 www.deko.dk / www.deko.com	Projekt/Project: DEKO GV 1090	
	Sags Nr./Case No.: L1J	Emne/Subject: L1J	Dato/Date: 2016-10-06-VXX
Mål/Scale: 1:1		Revideret/Revision: 2016-10-06-VXX	Signatur Signature EBR

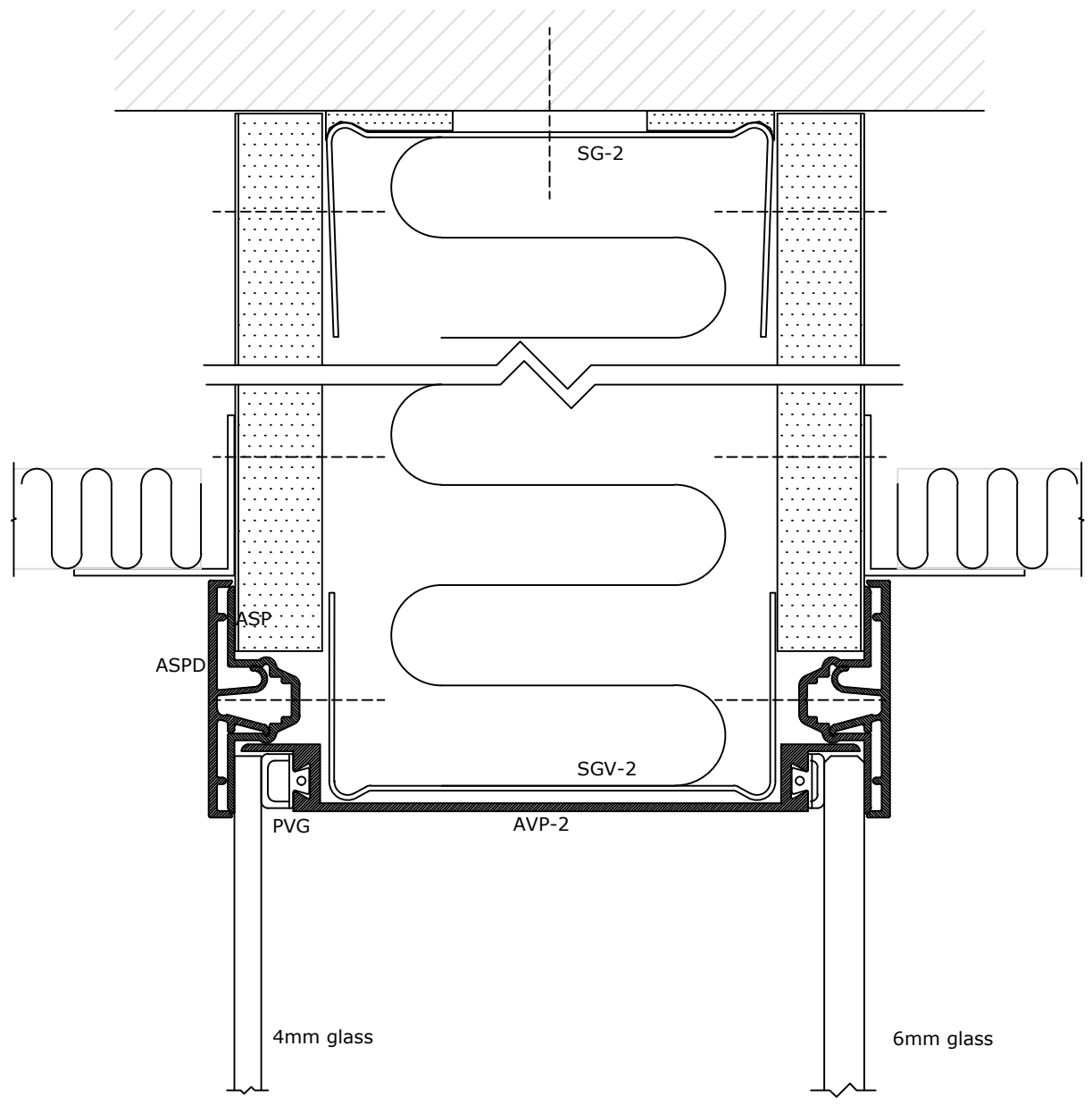

	DEKO Tlf./Tel: +45 43 55 77 11 www.deko.dk / www.deko.com	Projekt/Project: DEKO GV 1090	
	Sags Nr./Case No.: L1K	Emne/Subject: L1K	Dato/Date:
Mål/Scale: 1:1		Revideret/Revision: 2016-10-06-VXX	Signatur Signature EBR

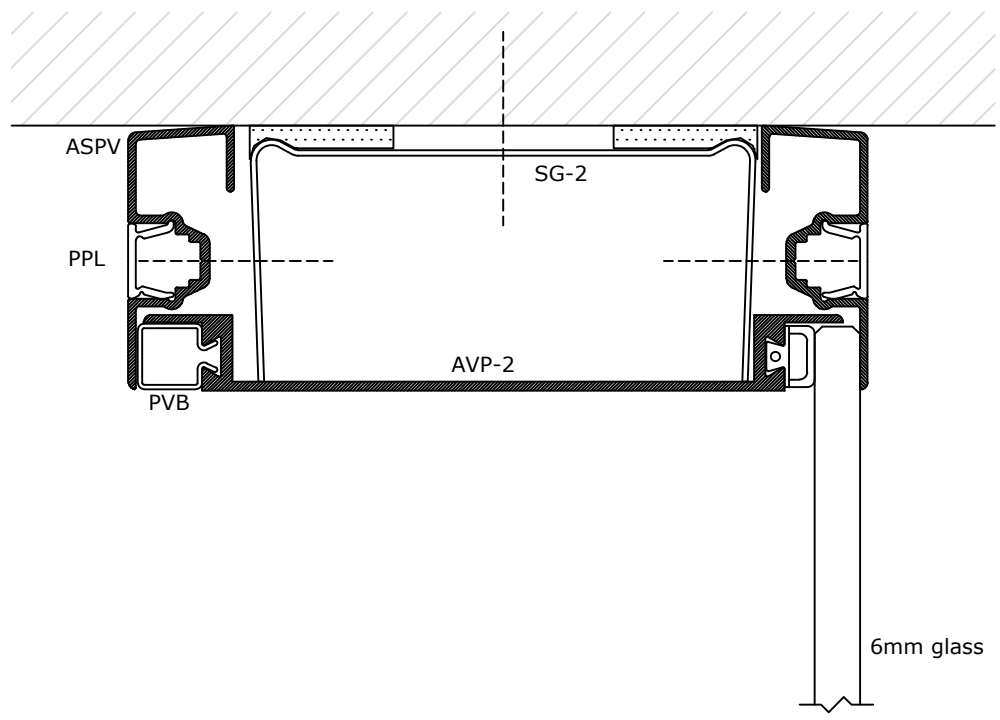

	DEKO Tlf./Tel: +45 43 55 77 11 www.deko.dk / www.deko.com		Projekt/Project: DEKO GV 1090	
	Sags Nr./Case No.:	Emne/Subject: L1L	Dato/Date:	Tegn. Nr. Sheet No. 1/1
Mål/Scale: 1:1		Revideret/Revision: 2016-10-06-VXX	Signatur Signature EBR	

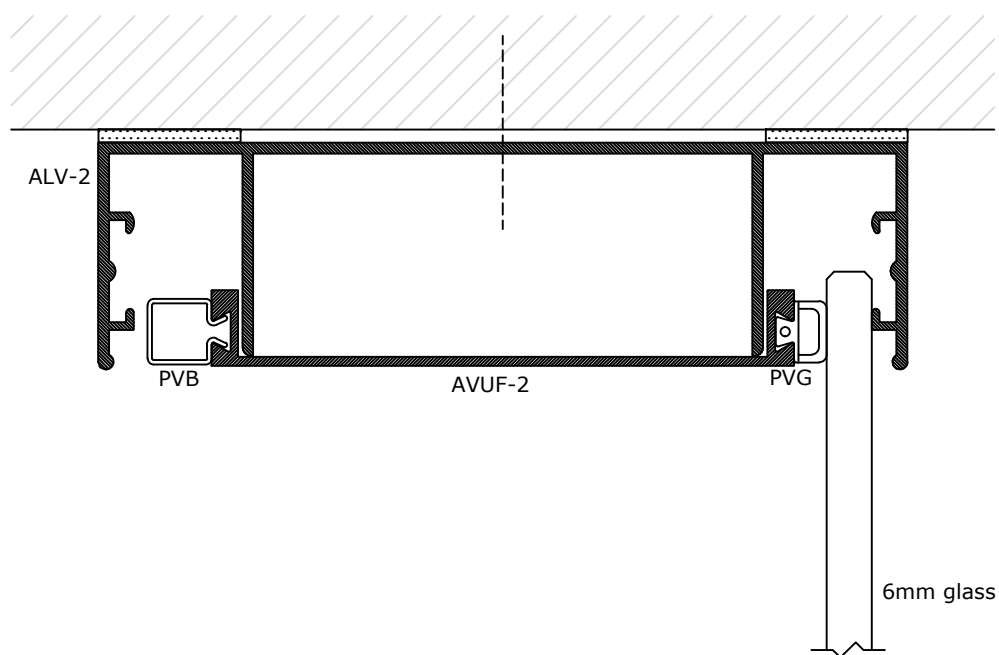

	DEKO Tlf./Tel: +45 43 55 77 11 www.deko.dk / www.deko.com	Projekt/Project: DEKO GV 1090	
	Sags Nr./Case No.:	Emne/Subject: L1M	Dato/Date:
Mål/Scale: 1:1		Revideret/Revision: 2016-10-06-VXX	Signatur Signature EBR

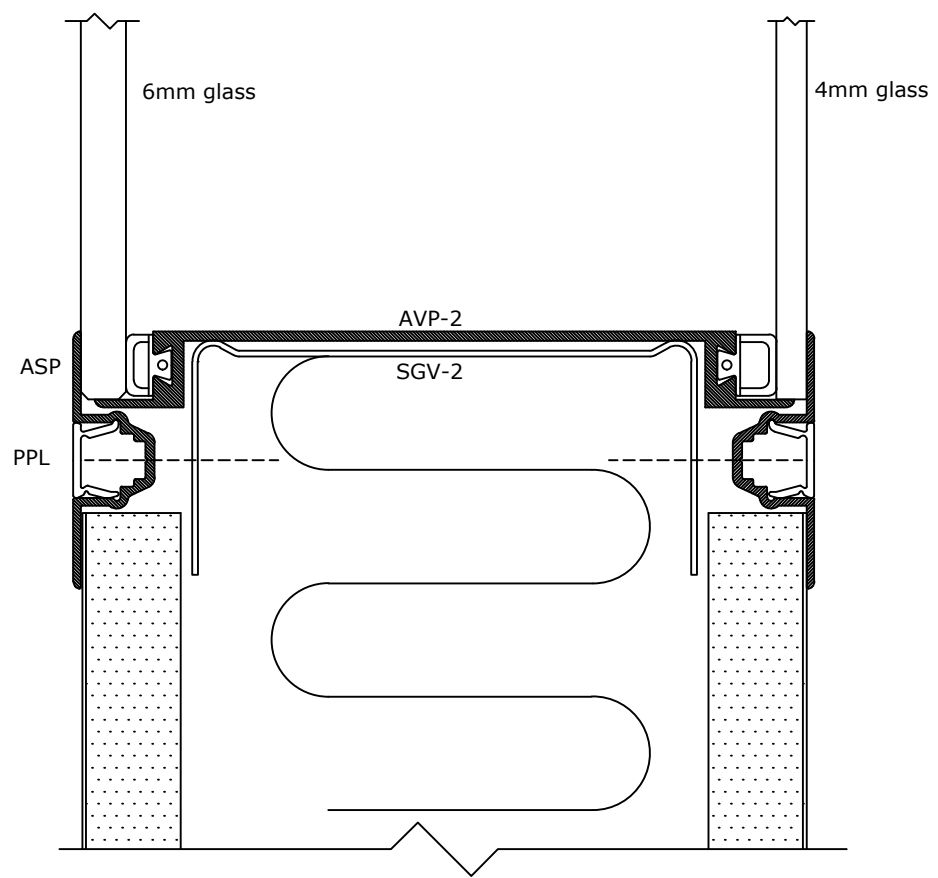

	DEKO Tlf./Tel: +45 43 55 77 11 www.deko.dk / www.deko.com	Projekt/Project: DEKO GV 1090	
	Sags Nr./Case No.: L2C	Emne/Subject: L2C	Dato/Date: 2016-10-06-VXX
Mål/Scale: 1:1		Revideret/Revision: 2016-10-06-VXX	Signatur Signature EBR

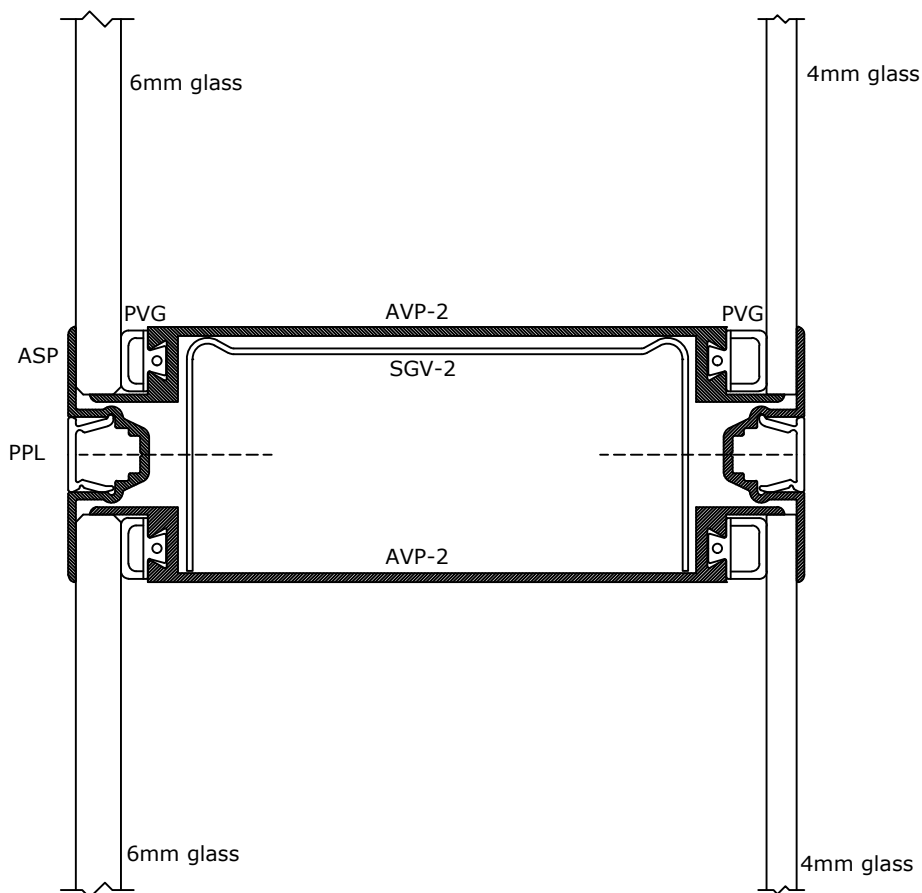

	DEKO Tlf./Tel: +45 43 55 77 11 www.deko.dk / www.deko.com	Projekt/Project: DEKO GV 1090	
	Sags Nr./Case No.: 	Emne/Subject: L2D	Dato/Date:
Mål/Scale: 1:1	 	Revideret/Revision: 2016-10-06-VXX	Signatur Signature EBR

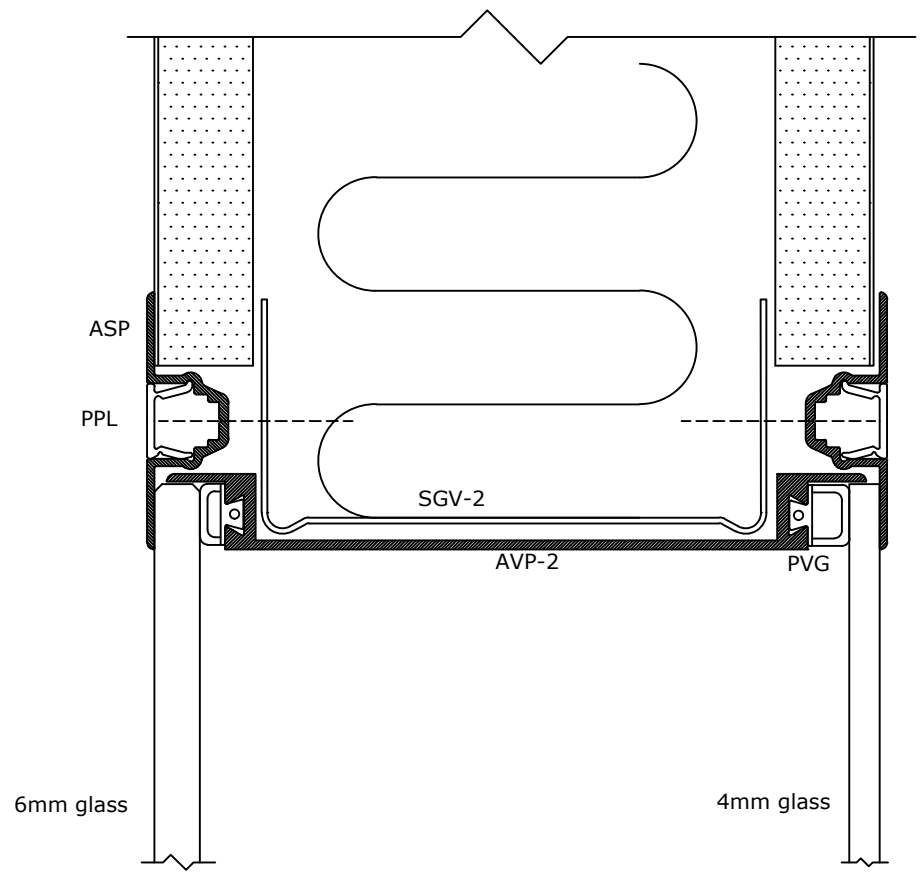

	DEKO Tlf./Tel: +45 43 55 77 11 www.deko.dk / www.deko.com	Projekt/Project: DEKO GV 1090	
	Sags Nr./Case No.:	Emne/Subject: L2E	Dato/Date:
Mål/Scale: 1:1		Revideret/Revision: 2016-10-06-VXX	Signatur Signature EBR

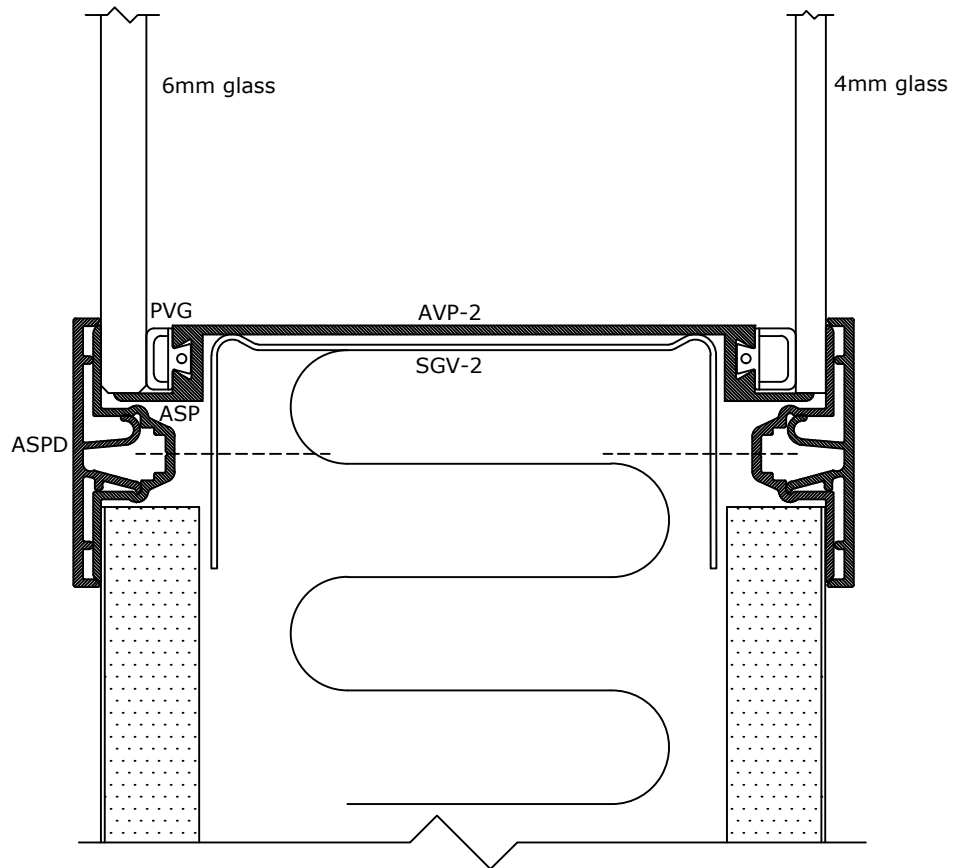

	DEKO Tlf./Tel: +45 43 55 77 11 www.deko.dk / www.deko.com	Projekt/Project: DEKO GV 1090	
	Sags Nr./Case No.:	Emne/Subject: L2F	Dato/Date:
Mål/Scale: 1:1		Revideret/Revision: 2016-10-06-VXX	Signatur Signature EBR

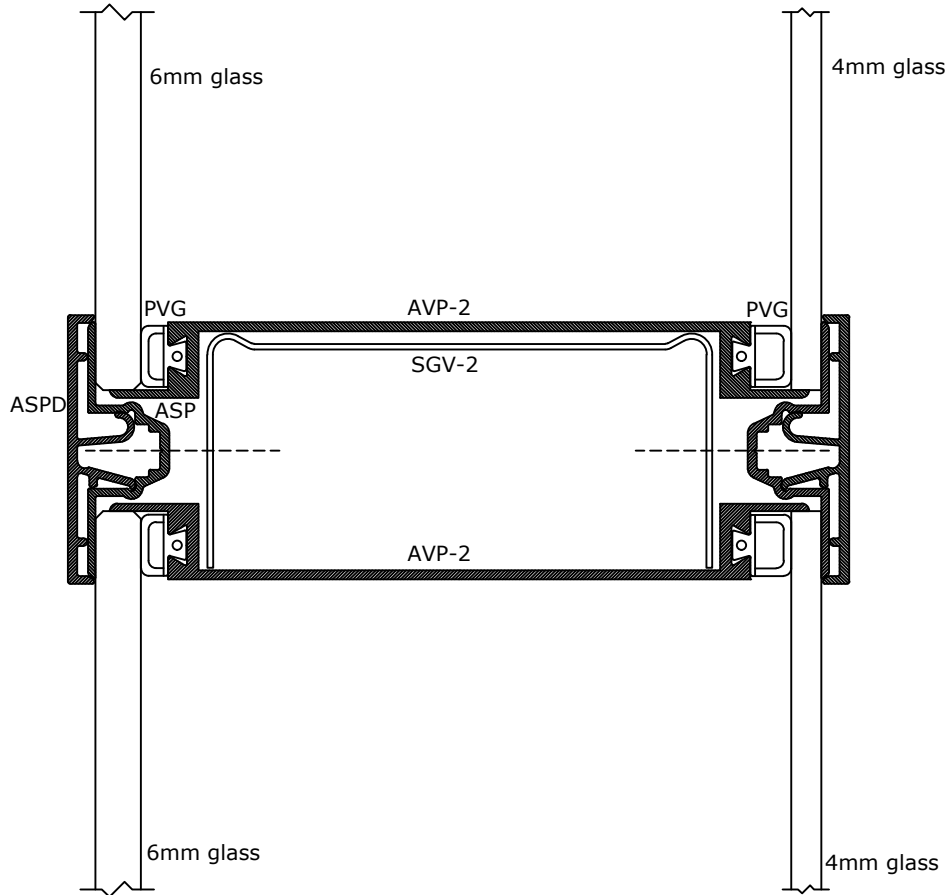

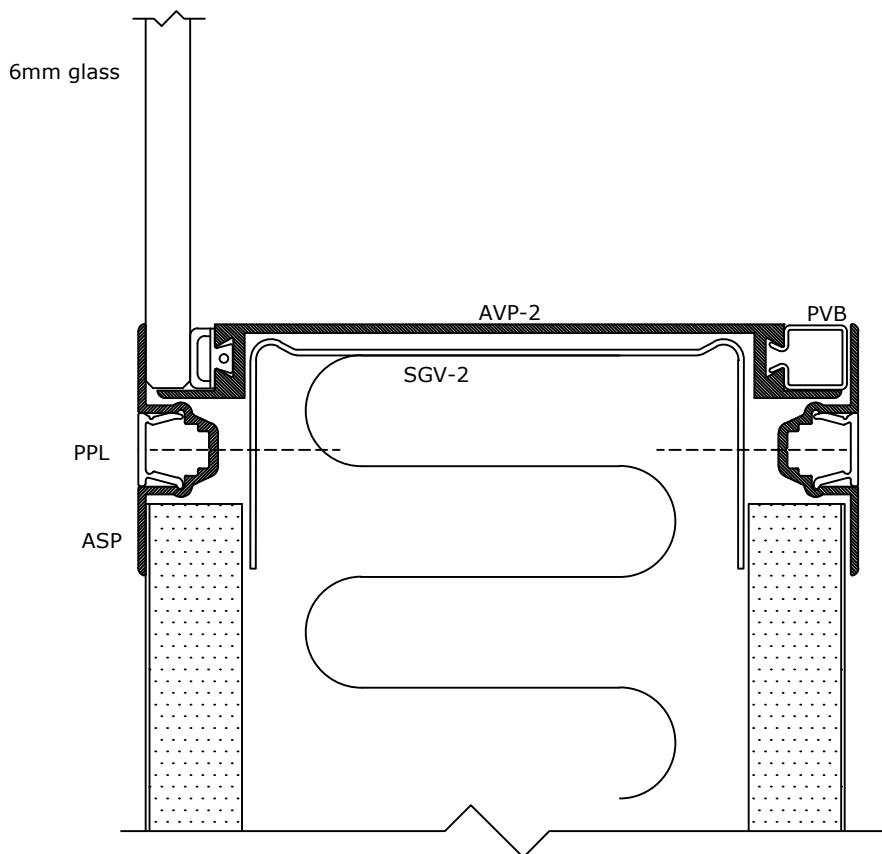

	DEKO Tlf./Tel: +45 43 55 77 11 www.deko.dk / www.deko.com	Projekt/Project: DEKO GV 1090	
	Sags Nr./Case No.:	Emne/Subject: L2G	Dato/Date:
Mål/Scale: 1:1		Revideret/Revision: 2016-10-06-VXX	Signatur Signature EBR



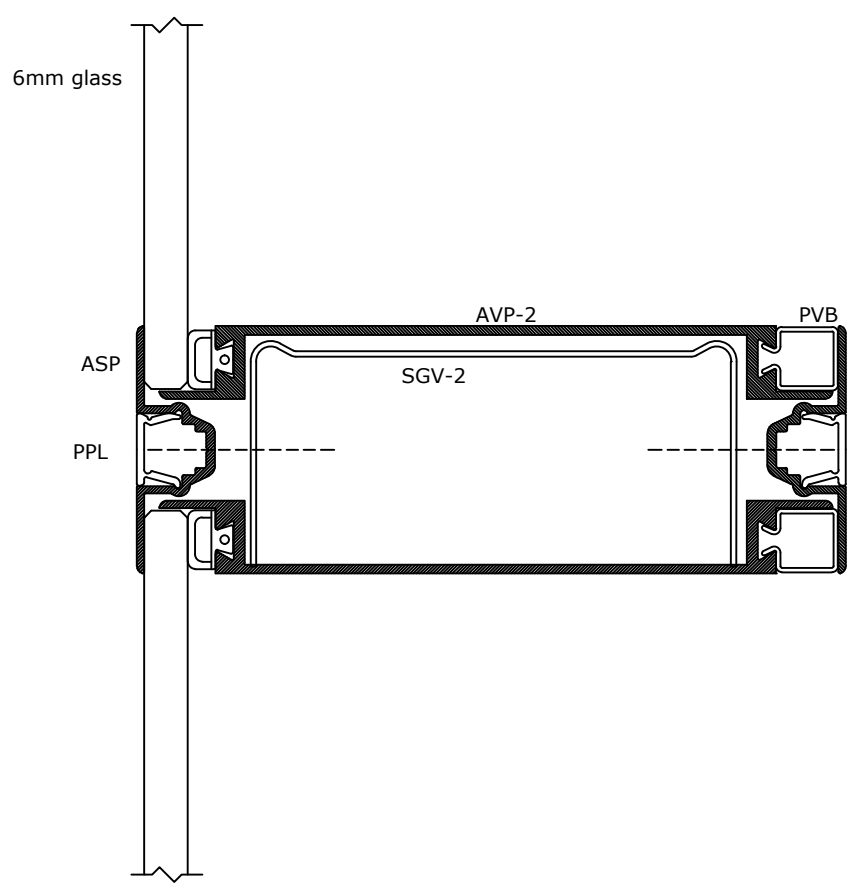

	DEKO Tlf./Tel: +45 43 55 77 11 www.deko.dk / www.deko.com	Projekt/Project: DEKO GV 1090	
	Sags Nr./Case No.: L2K	Emne/Subject: L2K	Dato/Date:
Mål/Scale: 1:1		Revideret/Revision: 2016-10-06-VXX	Signatur Signature EBR

1090 L2L

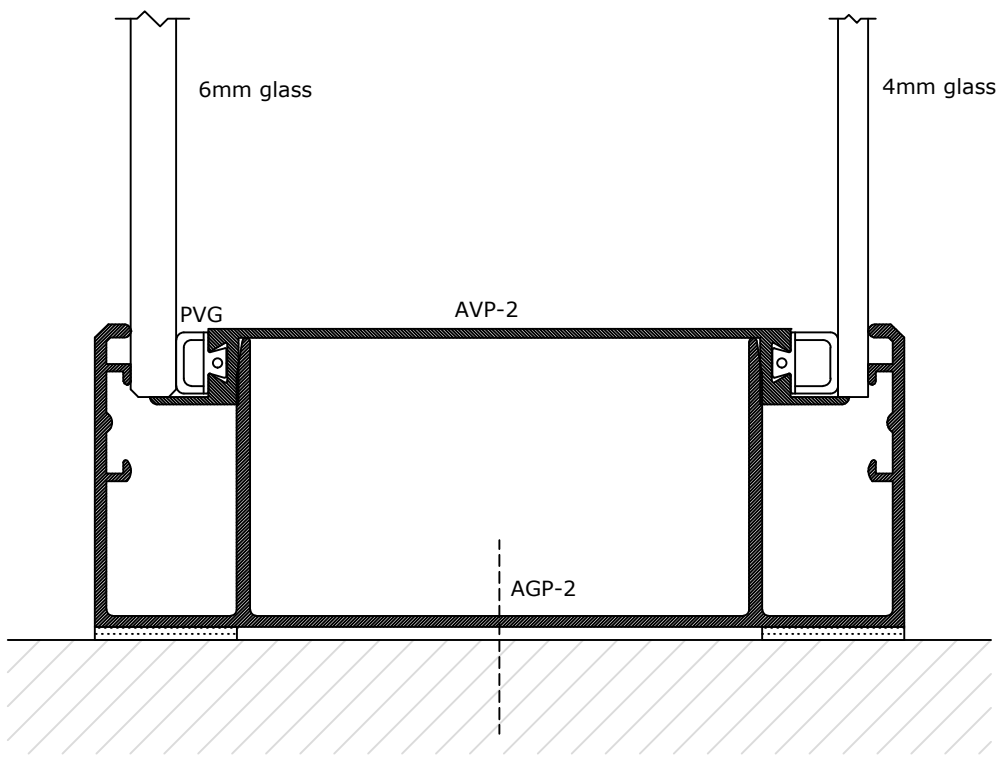

	DEKO Tlf./Tel: +45 43 55 77 11 www.deko.dk / www.deko.com	Projekt/Project: DEKO GV 1090	
	Sags Nr./Case No.:	Emne/Subject: L2L	Dato/Date:
Mål/Scale: 1:1		Revideret/Revision: 2016-10-06-VXX	Signatur Signature EBR



	DEKO Tlf./Tel: +45 43 55 77 11 www.deko.dk / www.deko.com	Projekt/Project: DEKO GV 1090	
	Sags Nr./Case No.: 	Emne/Subject: L3B	Dato/Date:
Mål/Scale: 1:1	 	Revideret/Revision: 2016-10-06-VXX	Signatur Signature EBR

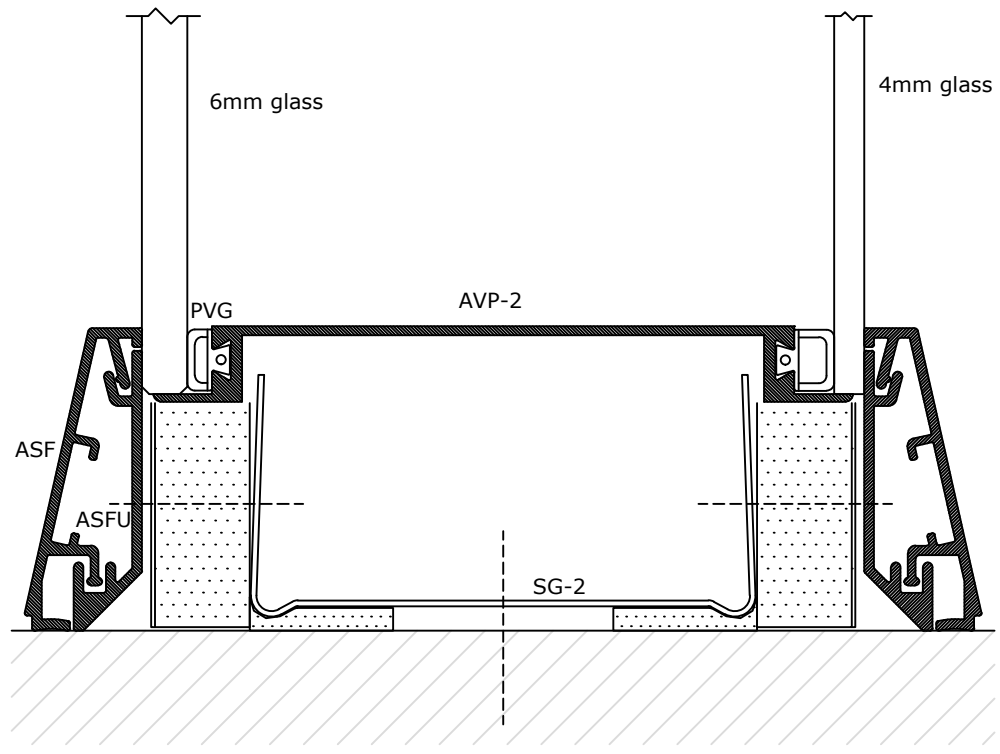

	DEKO Tlf./Tel: +45 43 55 77 11 www.deko.dk / www.deko.com		Projekt/Project: DEKO GV 1090	
	Sags Nr./Case No.:	Emne/Subject: L3E	Dato/Date:	Tegn. Nr. Sheet No. 1/1
Mål/Scale: 1:1		Revideret/Revision: 2016-10-06-VXX	Signatur Signature EBR	

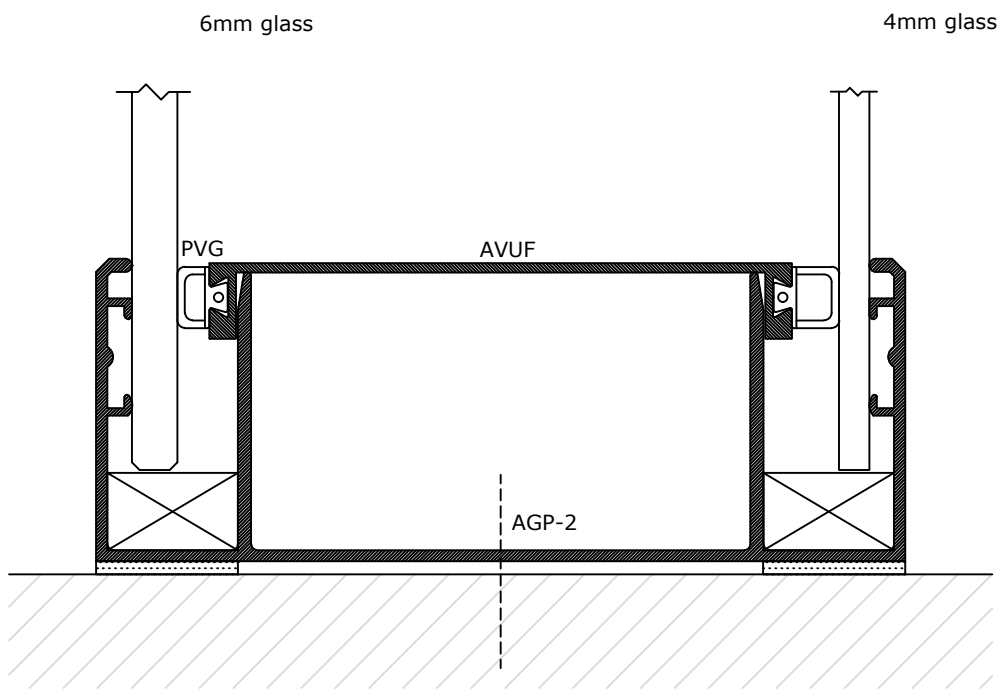

	DEKO Tlf./Tel: +45 43 55 77 11 www.deko.dk / www.deko.com	Projekt/Project: DEKO GV 1090	
	Sags Nr./Case No.: 	Emne/Subject: L3H	Dato/Date:
Mål/Scale: 1:1	 	Revideret/Revision: 2016-10-06-VXX	Signatur Signature EBR

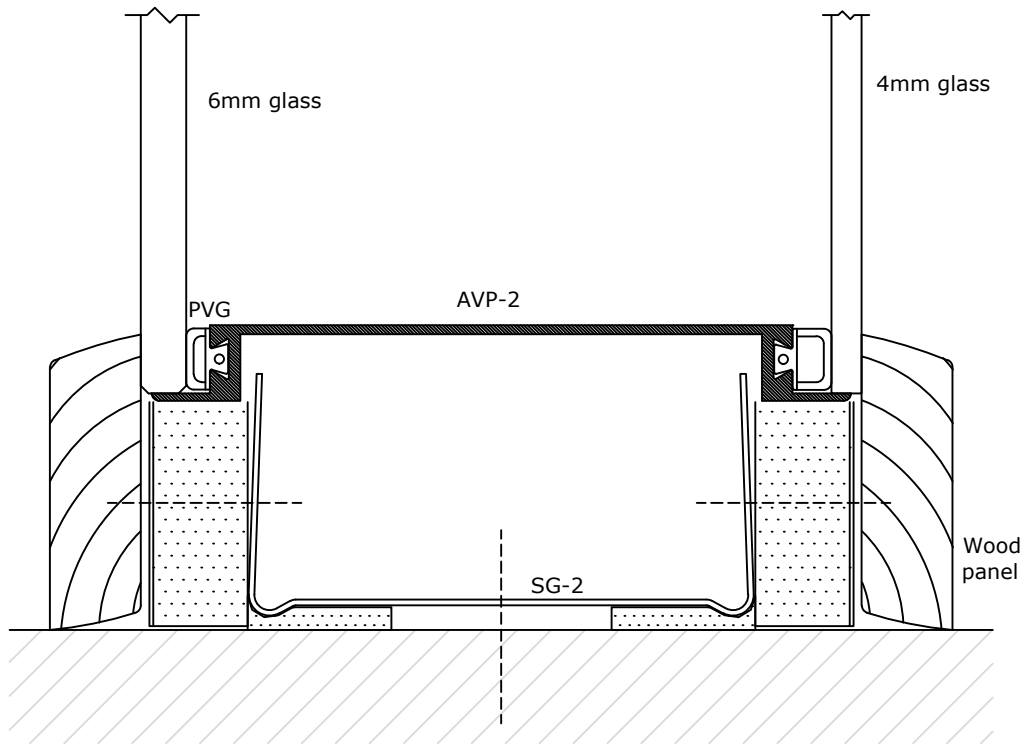

	DEKO Tlf./Tel: +45 43 55 77 11 www.deko.dk / www.deko.com	Projekt/Project: DEKO GV 1090	
	Sags Nr./Case No.: L3J	Emne/Subject:	Dato/Date:
Mål/Scale: 1:1		Revideret/Revision: 2016-10-06-VXX	Signatur Signature EBR

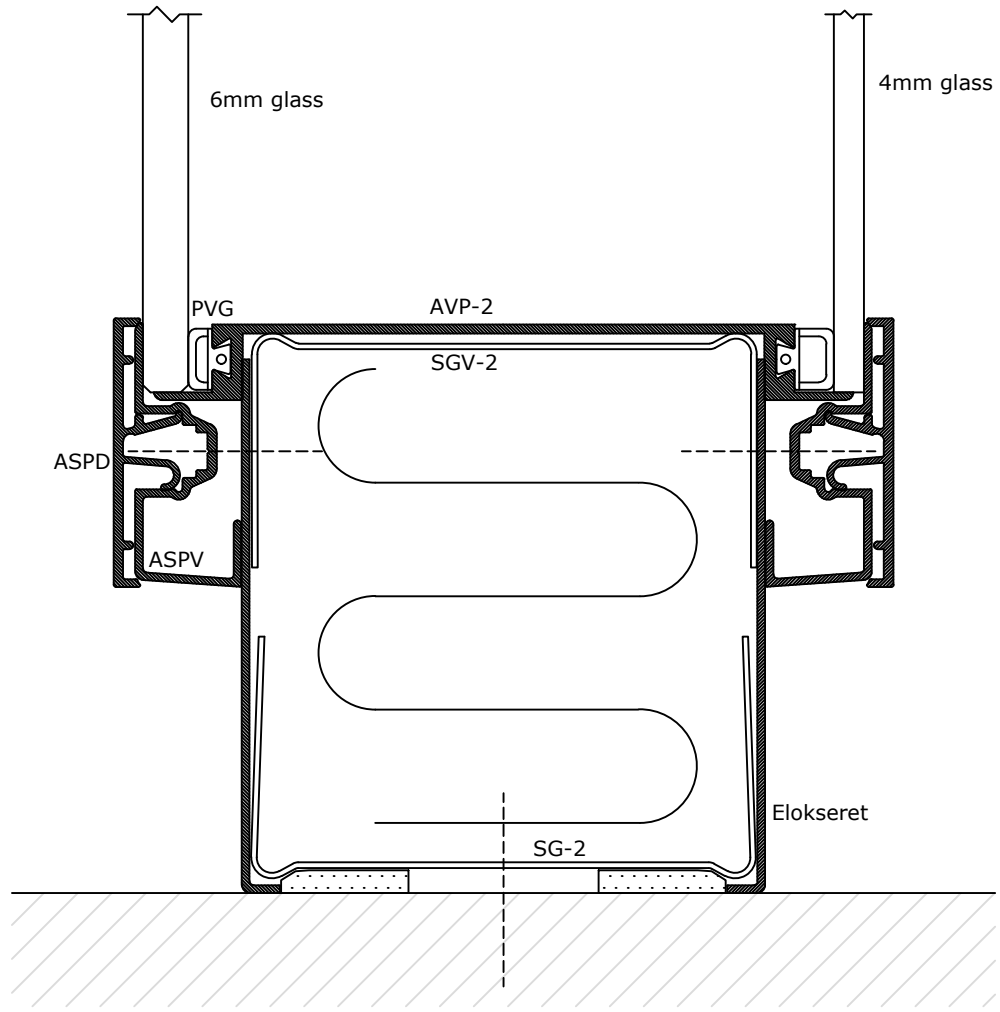

	DEKO Tlf./Tel: +45 43 55 77 11 www.deko.dk / www.deko.com	Projekt/Project: DEKO GV 1090	
	Sags Nr./Case No.: L3K	Emne/Subject: L3K	Dato/Date:
Mål/Scale: 1:1		Revideret/Revision: 2016-10-06-VXX	Signatur Signature EBR

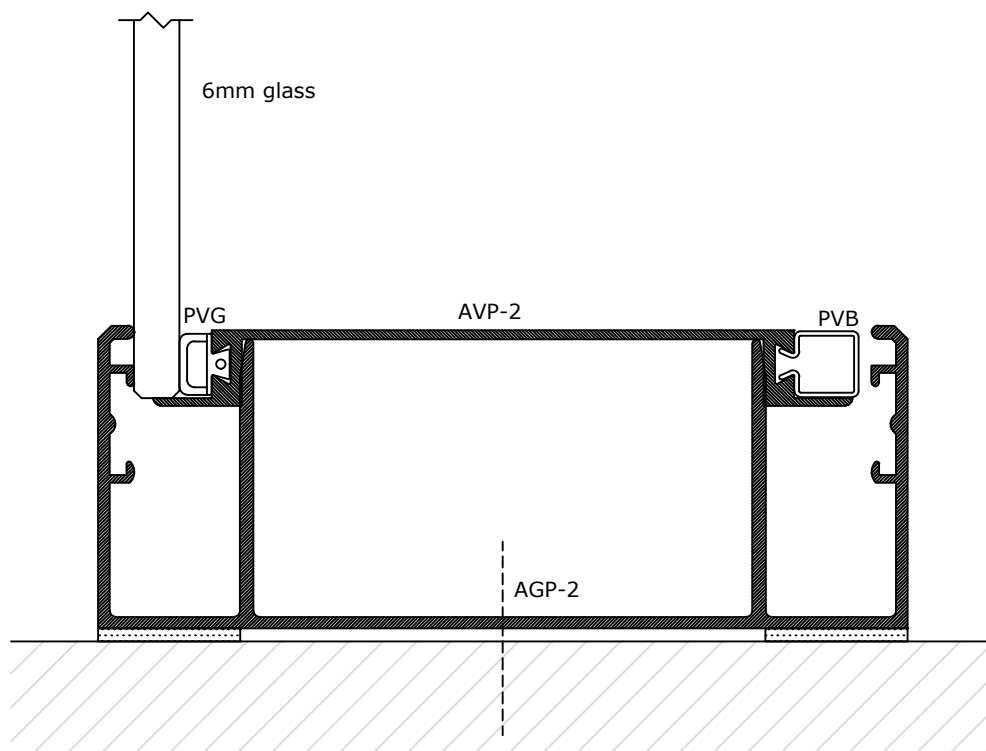

	DEKO Tlf./Tel: +45 43 55 77 11 www.deko.dk / www.deko.com	Projekt/Project: DEKO GV 1090	
	Sags Nr./Case No.:	Emne/Subject: L3L	Dato/Date:
Mål/Scale: 1:1		Revideret/Revision: 2016-10-06-VXX	Signatur Signature EBR

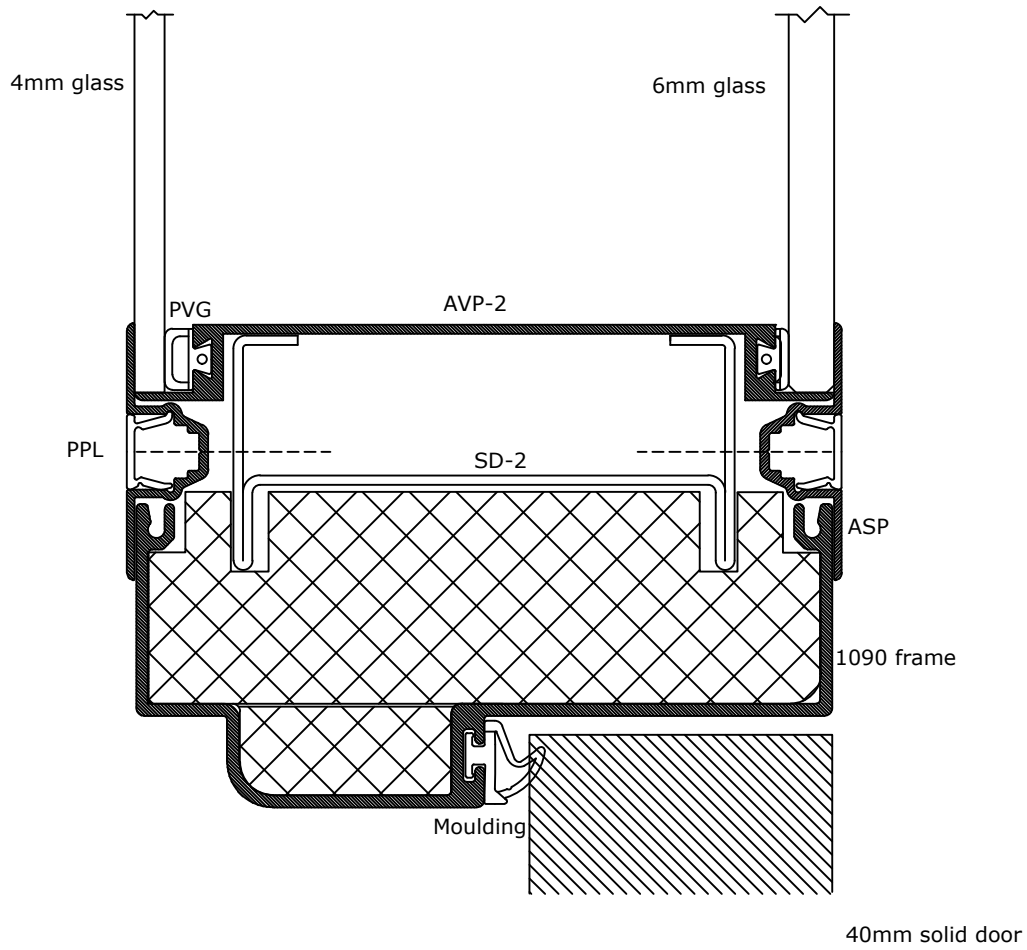

	DEKO Tlf./Tel: +45 43 55 77 11 www.deko.dk / www.deko.com	Projekt/Project: DEKO GV 1090	
	Sags Nr./Case No.:	Emne/Subject: L4C	Dato/Date:
Mål/Scale: 1:1		Revideret/Revision: 2016-10-06-VXX	Signatur Signature EBR

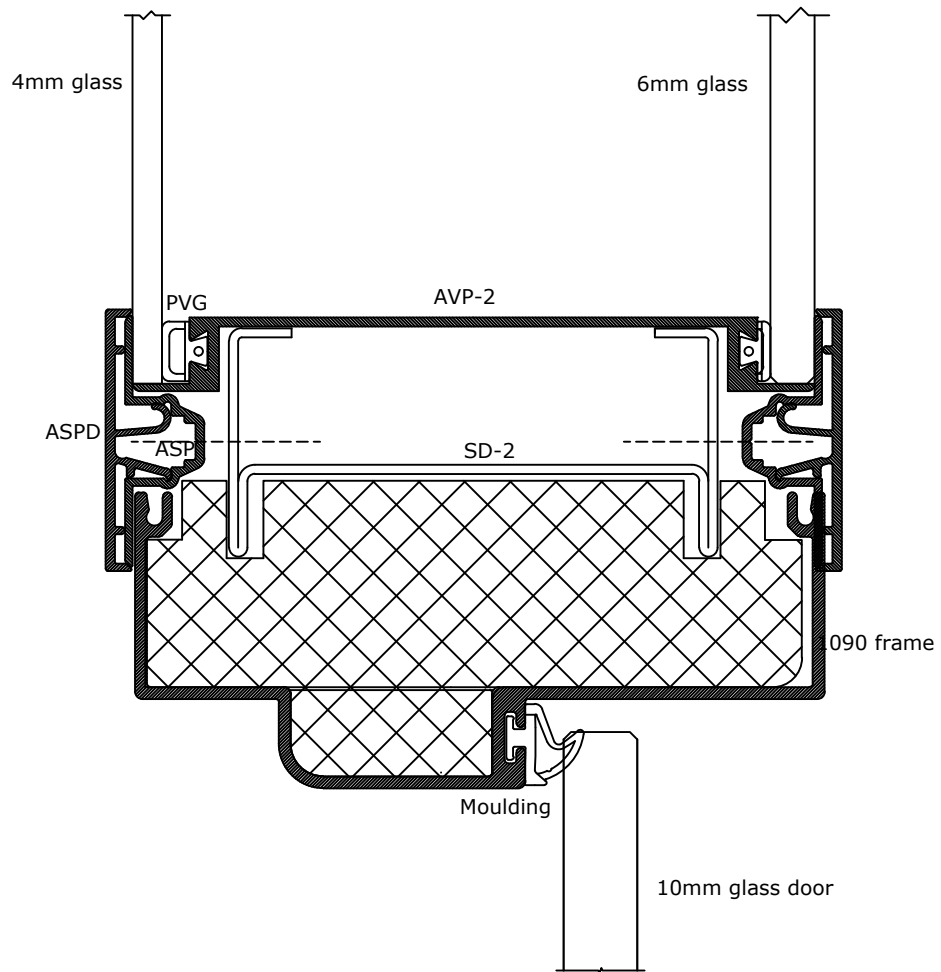

	DEKO Tlf./Tel: +45 43 55 77 11 www.deko.dk / www.deko.com	Projekt/Project: DEKO GV 1090	
	Sags Nr./Case No.: L4D	Emne/Subject:	Dato/Date:
Mål/Scale: 1:1		Revideret/Revision: 2016-10-06-VXX	Signatur Signature EBR

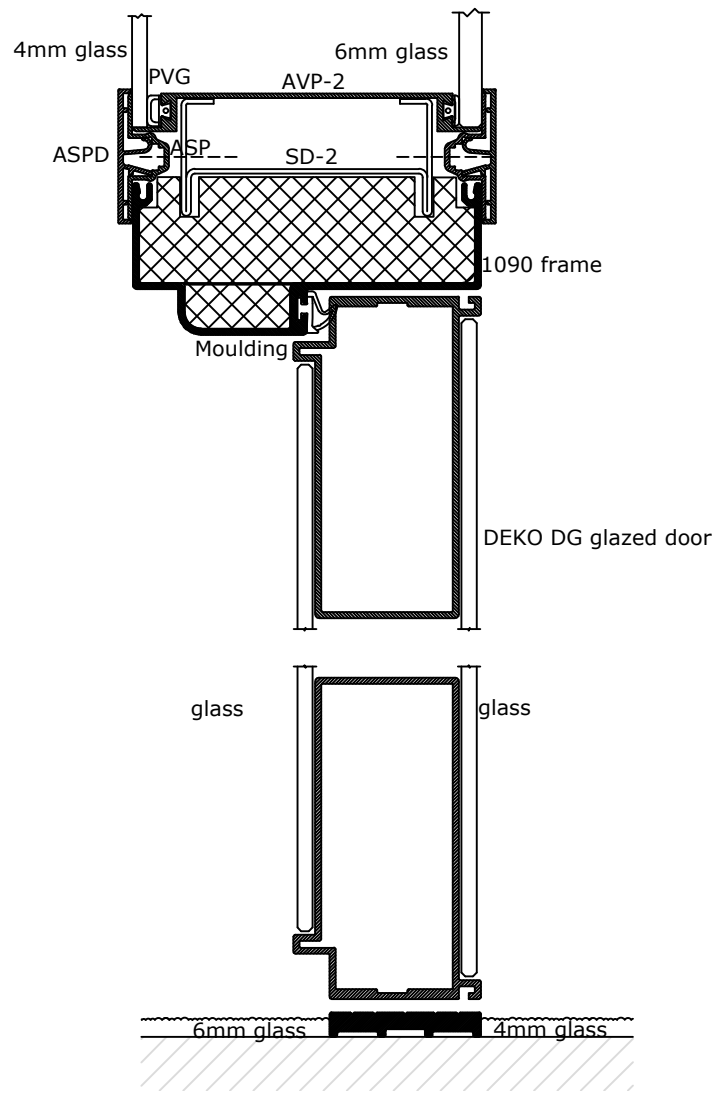

	DEKO Tlf./Tel: +45 43 55 77 11 www.deko.dk / www.deko.com	Projekt/Project: DEKO GV 1090	
	Sags Nr./Case No.:	Emne/Subject: L4G	Dato/Date:
Mål/Scale: 1:1		Revideret/Revision: 2016-10-06-VXX	Signatur Signature EBR

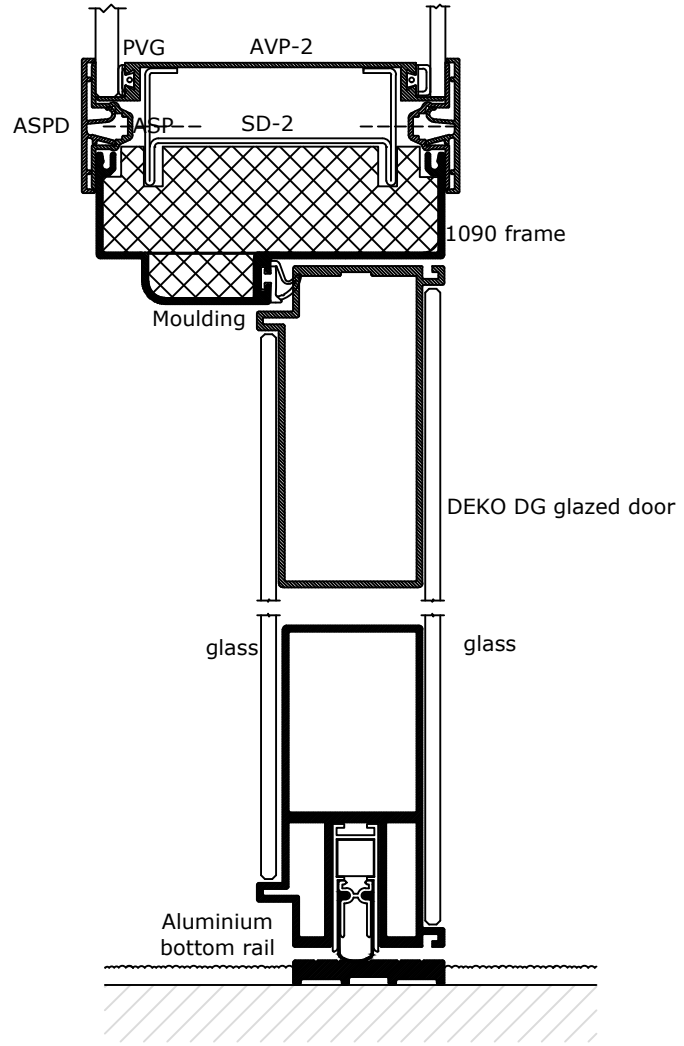

	DEKO Tlf./Tel: +45 43 55 77 11 www.deko.dk / www.deko.com	Projekt/Project: DEKO GV 1090	
	Sags Nr./Case No.:	Emne/Subject: L4G	Dato/Date:
Mål/Scale: 1:2		Revideret/Revision: 2016-10-06-VXX	Signatur Signature EBR

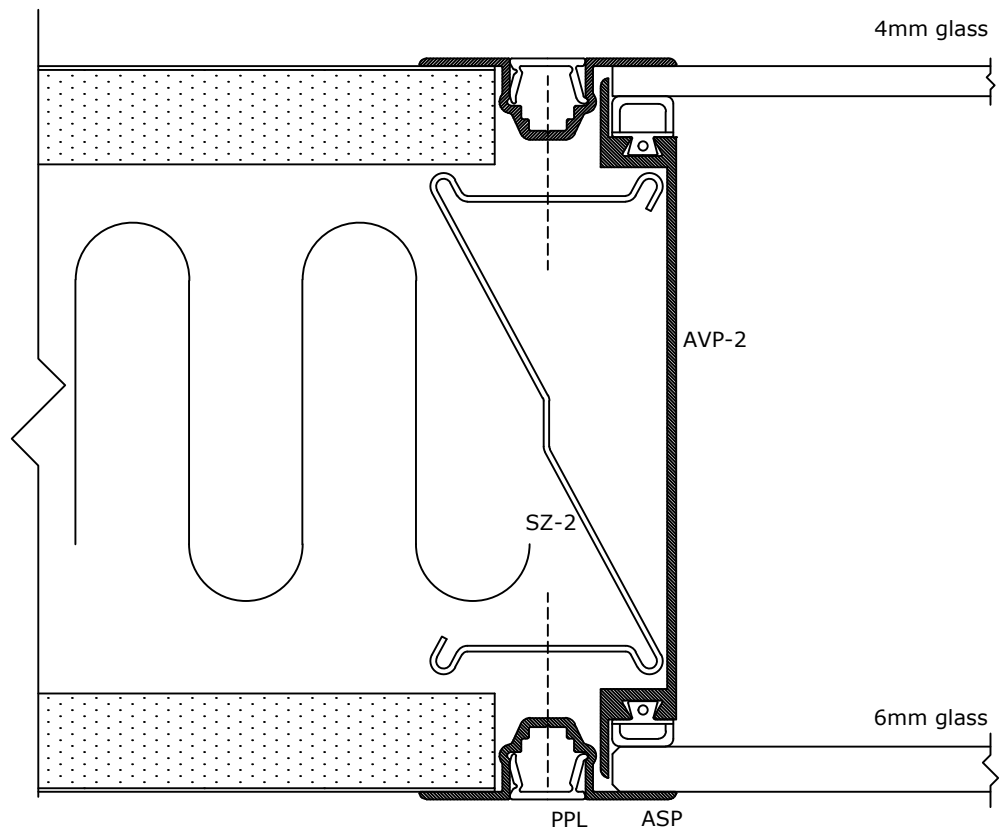

	DEKO Tlf./Tel: +45 43 55 77 11 www.deko.dk / www.deko.com	Projekt/Project: DEKO GV 1090	
	Sags Nr./Case No.: 	Emne/Subject: V1B	Dato/Date:
Mål/Scale: 1:1	 	Revideret/Revision: 2016-10-06-VXX	Signatur Signature EBR

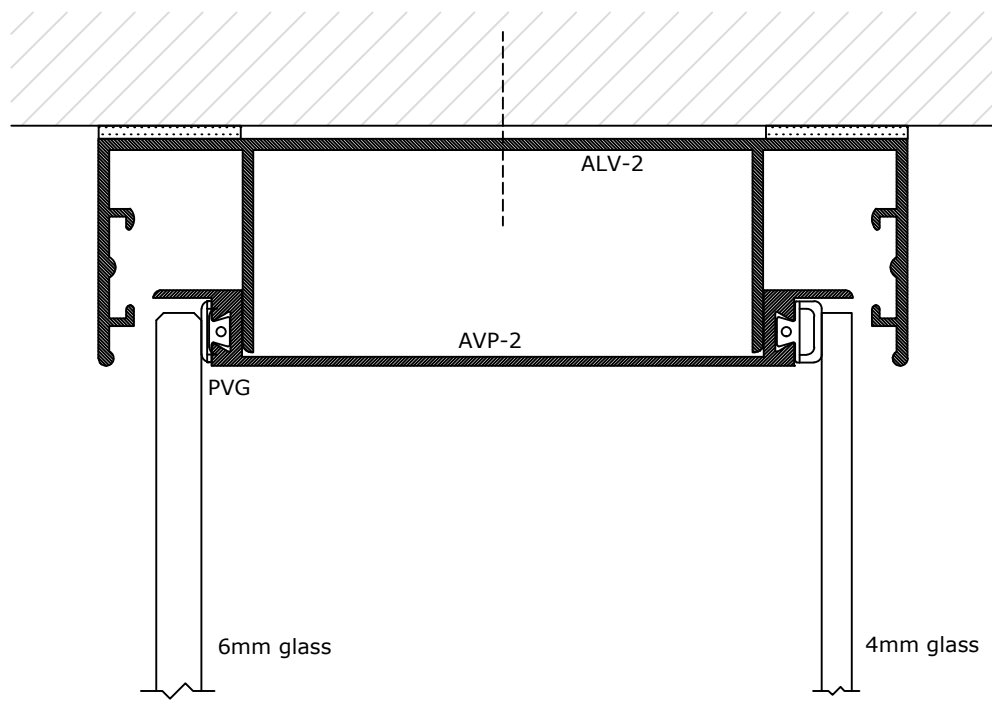

	DEKO Tlf./Tel: +45 43 55 77 11 www.deko.dk / www.deko.com		Projekt/Project: DEKO GV 1090	
	Sags Nr./Case No.:	Emne/Subject: V1C	Dato/Date:	Tegn. Nr. Sheet No. 1/1
Mål/Scale: 1:1		Revideret/Revision: 2016-10-06-VXX	Signatur Signature EBR	

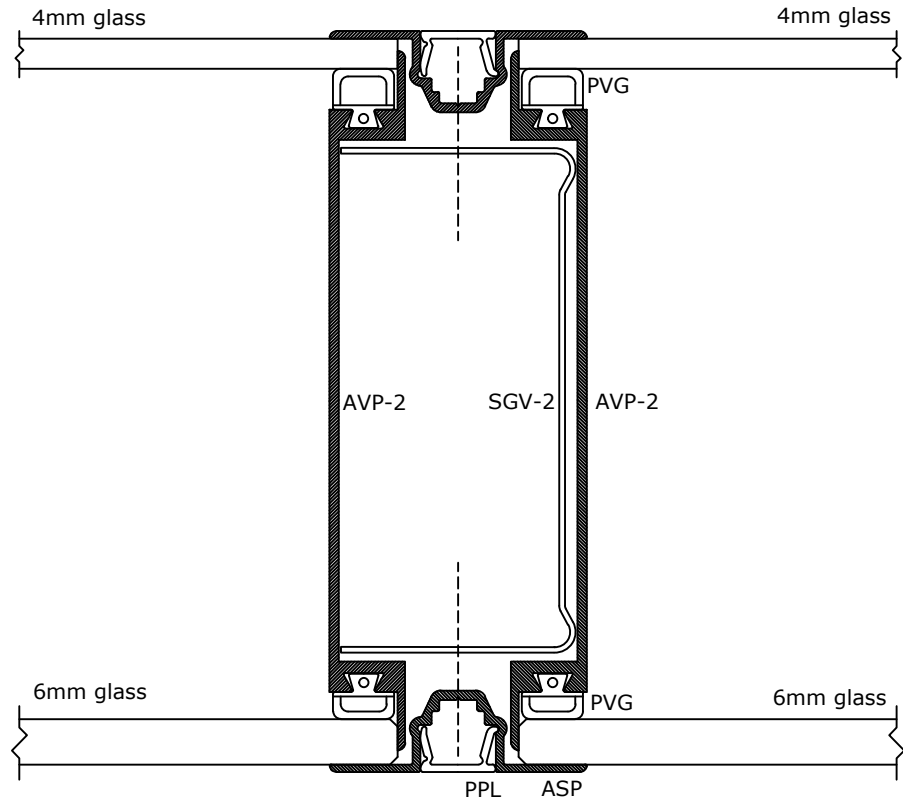

	DEKO Tlf./Tel: +45 43 55 77 11 www.deko.dk / www.deko.com	Projekt/Project: DEKO GV 1090	
	Sags Nr./Case No.: 	Emne/Subject: V1D	Dato/Date:
Mål/Scale: 1:1	 	Revideret/Revision: 2016-10-06-VXX	Signatur Signature EBR

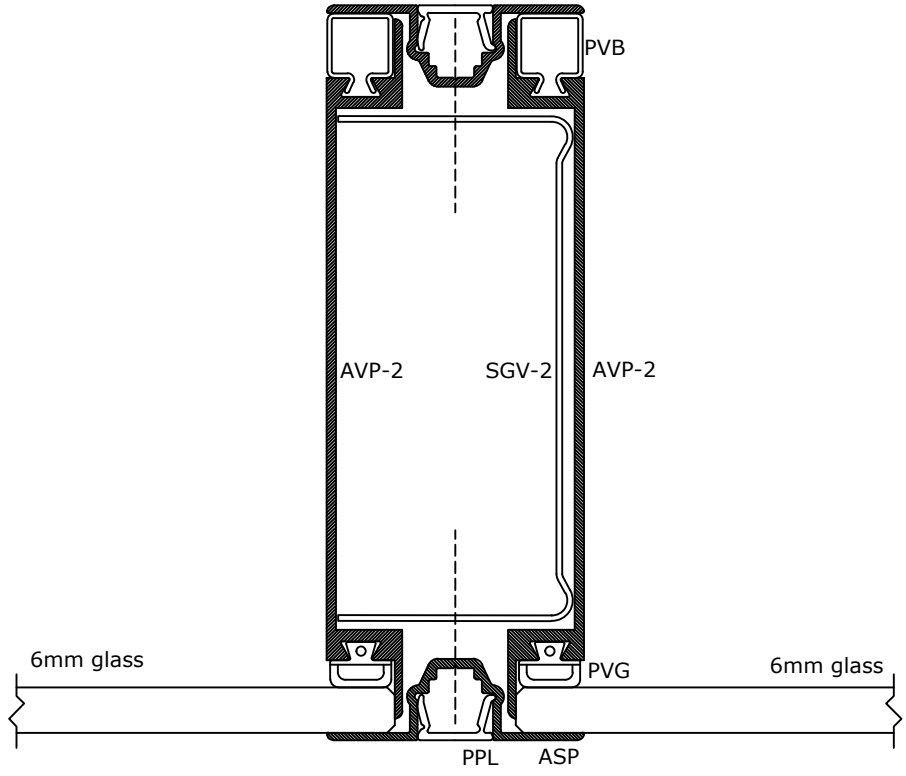

	DEKO Tlf./Tel: +45 43 55 77 11 www.deko.dk / www.deko.com	Projekt/Project: DEKO GV 1090	
	Sags Nr./Case No.:	Emne/Subject: V1E	Dato/Date:
Mål/Scale: 1:1		Revideret/Revision: 2016-10-06-VXX	Signatur Signature EBR

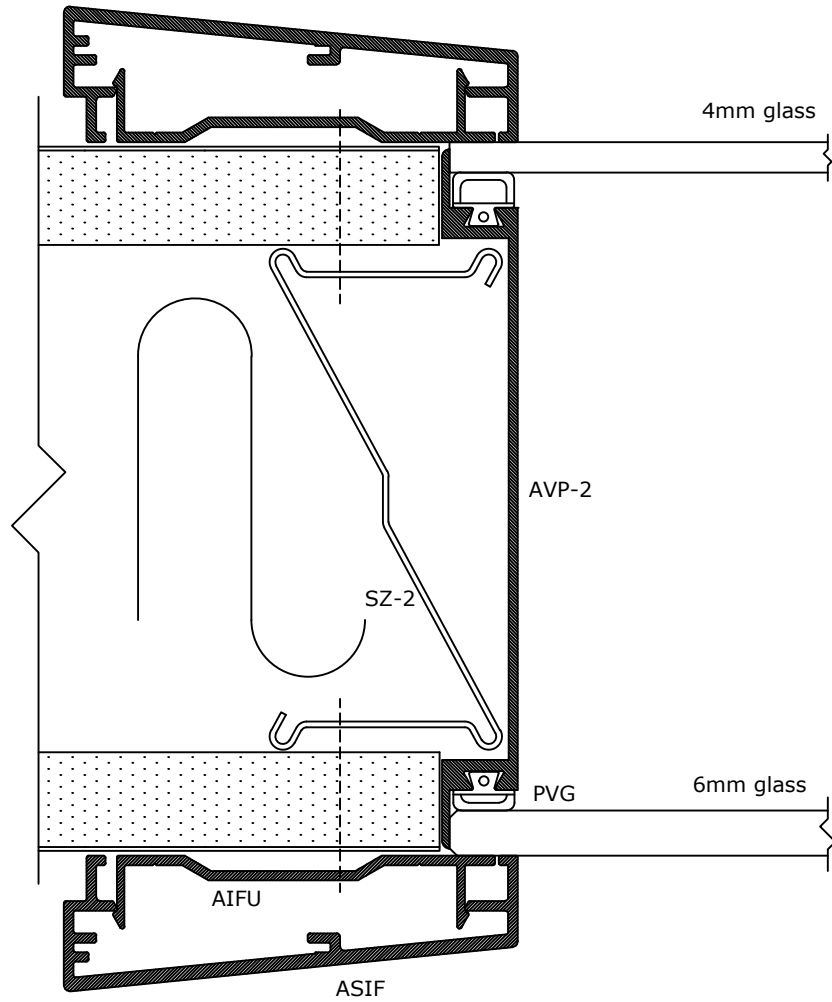

	DEKO Tlf./Tel: +45 43 55 77 11 www.deko.dk / www.deko.com	Projekt/Project: DEKO GV 1090	
	Sags Nr./Case No.:	Emne/Subject: V1F	Dato/Date:
Mål/Scale: 1:1		Revideret/Revision: 2016-10-06-VXX	Signatur Signature EBR

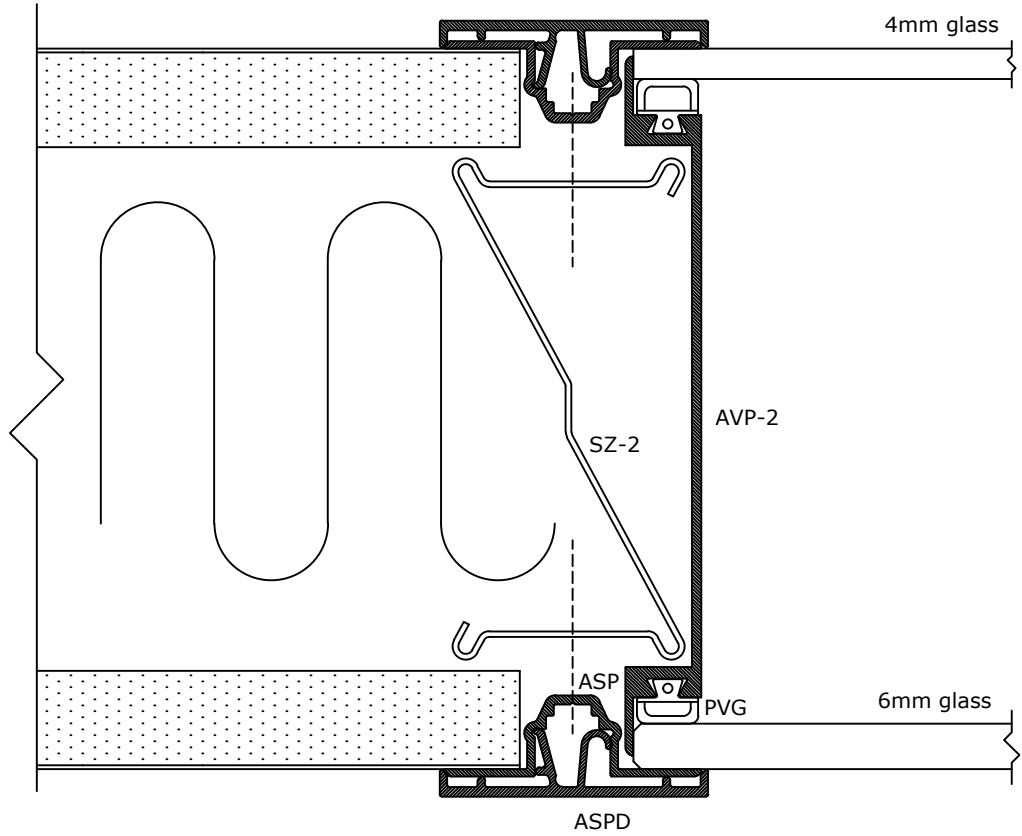

	DEKO Tlf./Tel: +45 43 55 77 11 www.deko.dk / www.deko.com	Projekt/Project: DEKO GV 1090	
	Sags Nr./Case No.:	Emne/Subject: V1H	Dato/Date:
Mål/Scale: 1:1		Revideret/Revision: 2016-10-06-VXX	Signatur Signature EBR

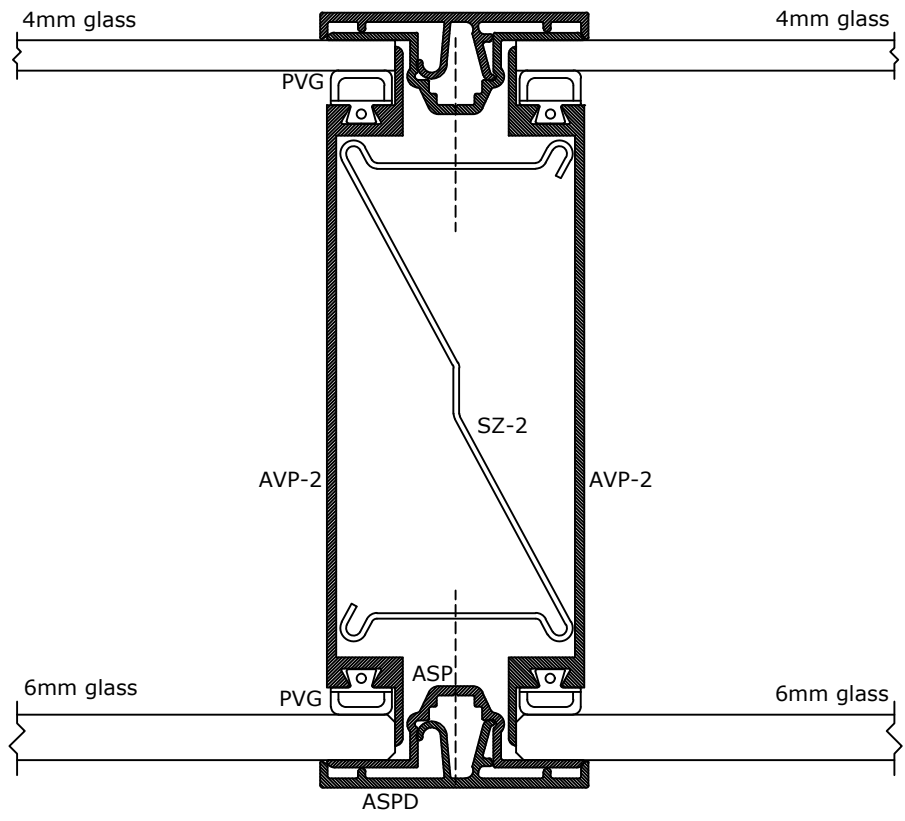

	DEKO Tlf./Tel: +45 43 55 77 11 www.deko.dk / www.deko.com	Projekt/Project: DEKO GV 1090	
	Sags Nr./Case No.: 	Emne/Subject: V1J	Dato/Date:
Mål/Scale: 1:1	 	Revideret/Revision: 2016-10-06-VXX	Signatur Signature EBR

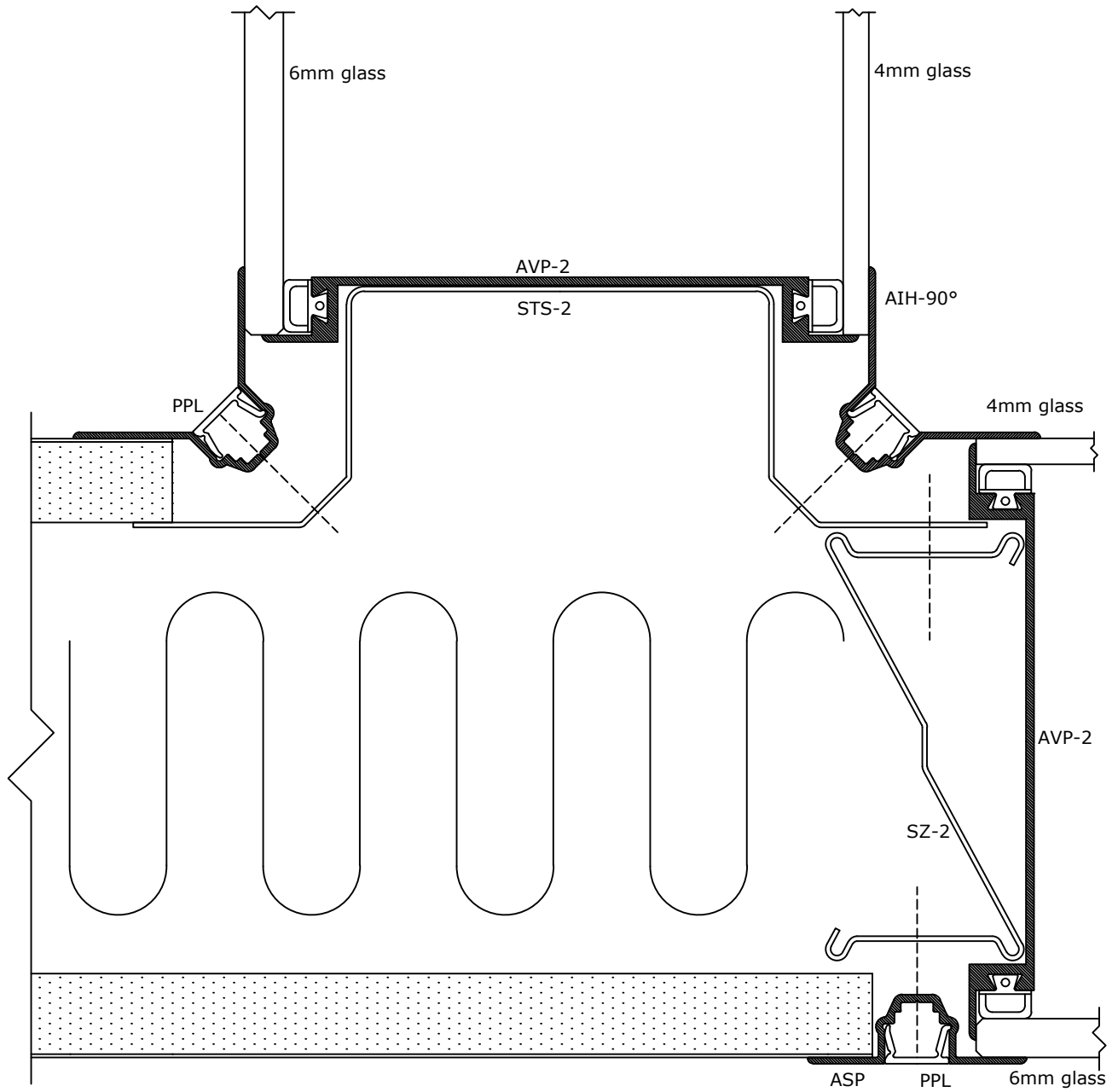

	DEKO Tlf./Tel: +45 43 55 77 11 www.deko.dk / www.deko.com	Projekt/Project: DEKO GV 1090	
	Sags Nr./Case No.: V2B	Emne/Subject:	Dato/Date:
Mål/Scale: 1:1		Revideret/Revision: 2016-10-06-VXX	Signatur Signature EBR

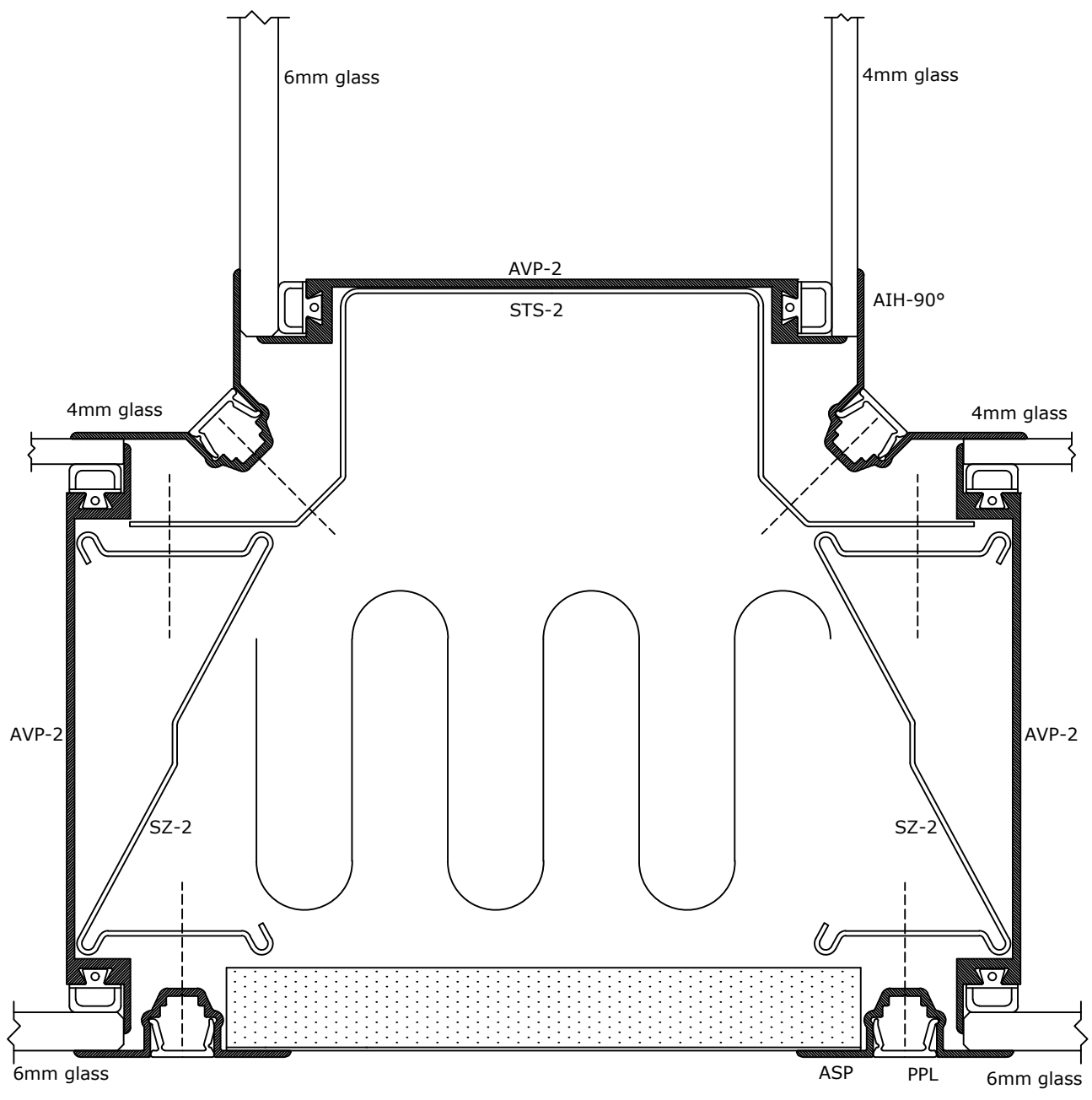

	DEKO Tlf./Tel: +45 43 55 77 11 www.deko.dk / www.deko.com	Projekt/Project: DEKO GV 1090	
	Sags Nr./Case No.: 	Emne/Subject: V2C	Dato/Date:
Mål/Scale: 1:1	 	Revideret/Revision: 2016-10-06-VXX	Signatur Signature EBR

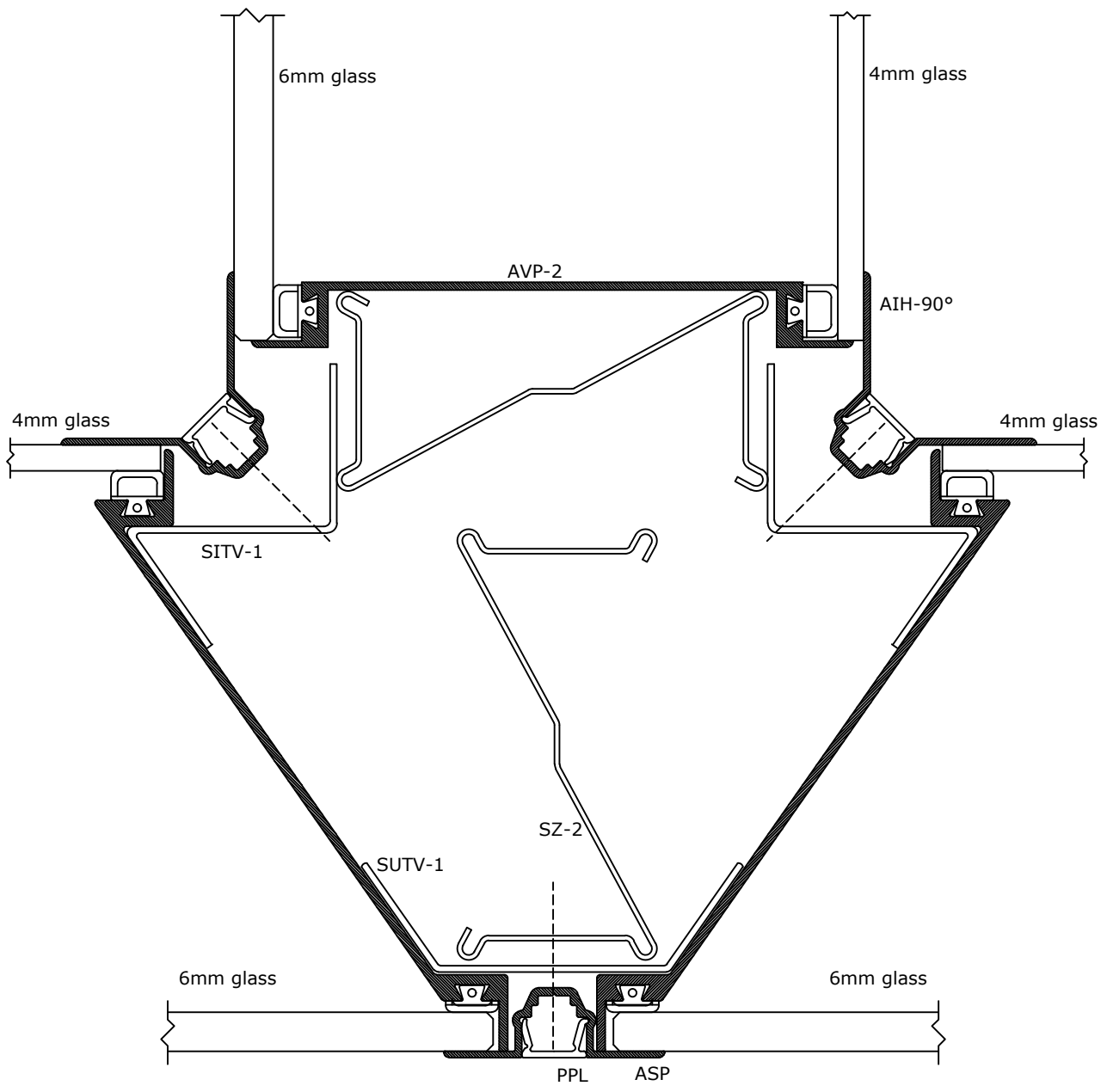

	DEKO Tlf./Tel: +45 43 55 77 11 www.deko.dk / www.deko.com	Projekt/Project: DEKO GV 1090	
	Sags Nr./Case No.: V2D	Emne/Subject:	Dato/Date:
Mål/Scale: 1:1		Revideret/Revision: 2016-10-06-VXX	Signatur Signature EBR

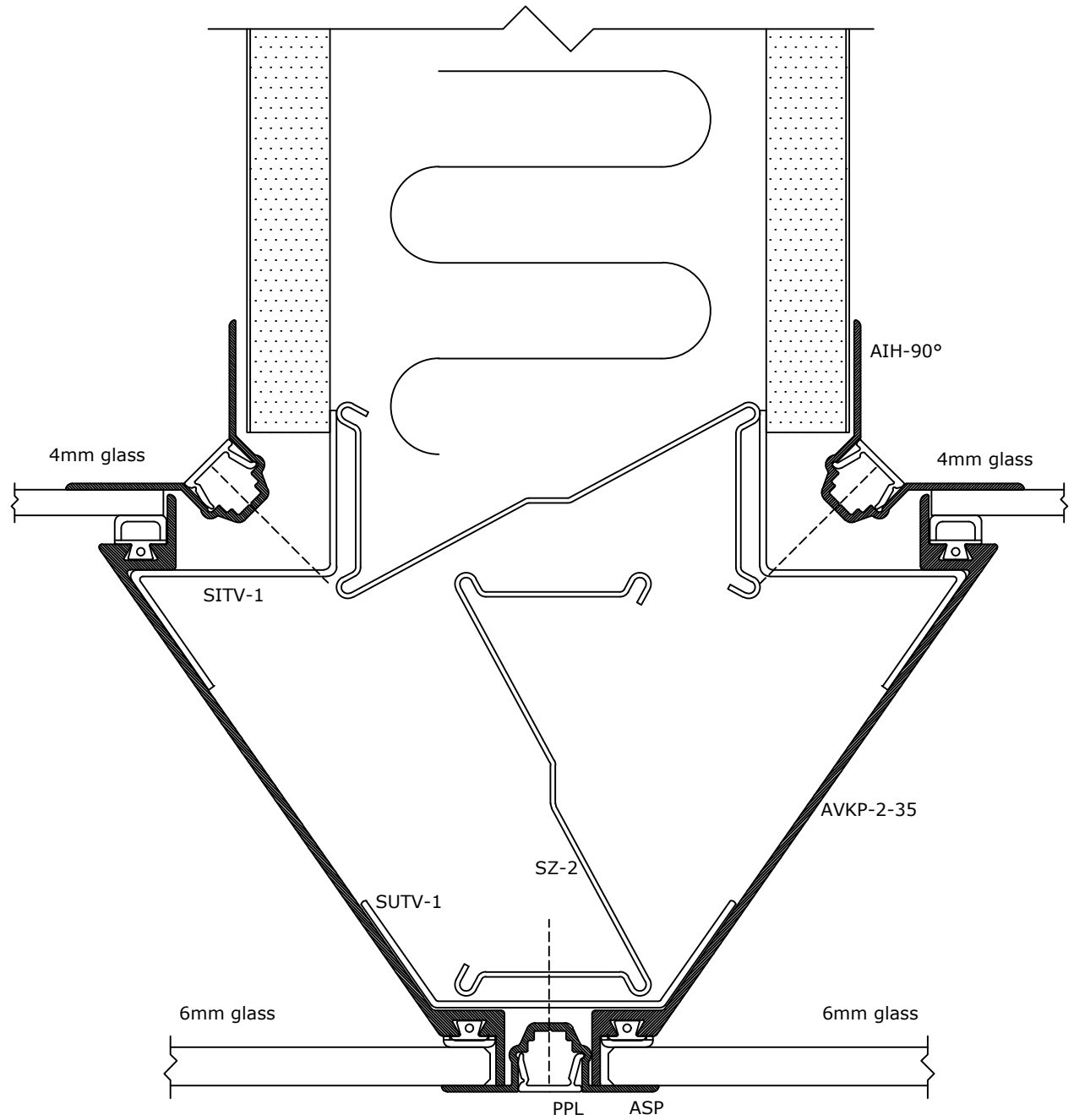

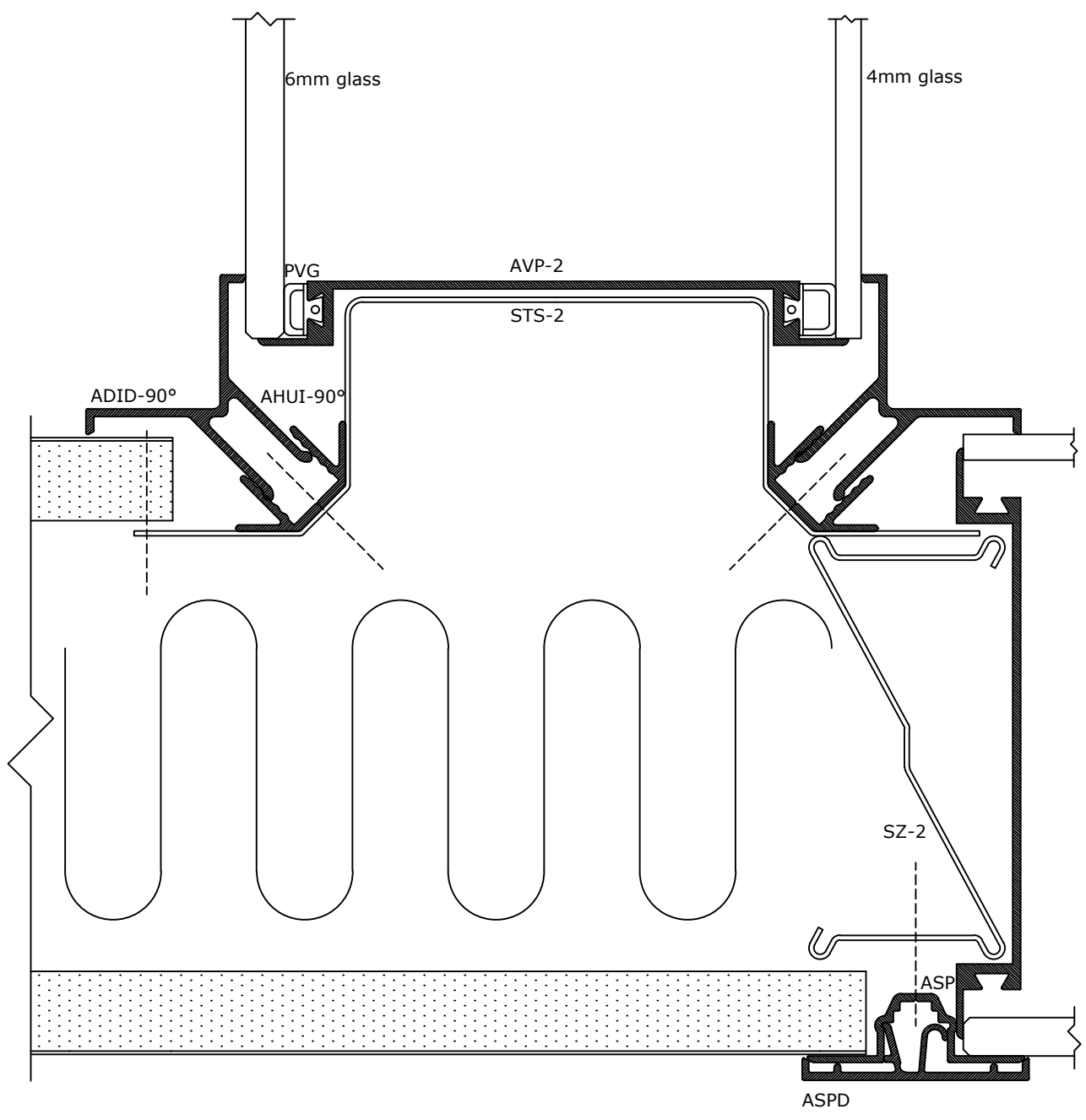

	DEKO Tlf./Tel: +45 43 55 77 11 www.deko.dk / www.deko.com	Projekt/Project: DEKO GV 1090	
	Sags Nr./Case No.:	Emne/Subject: VZE	Dato/Date:
Mål/Scale: 1:1		Revideret/Revision: 2016-10-06-VXX	Signatur Signature EBR



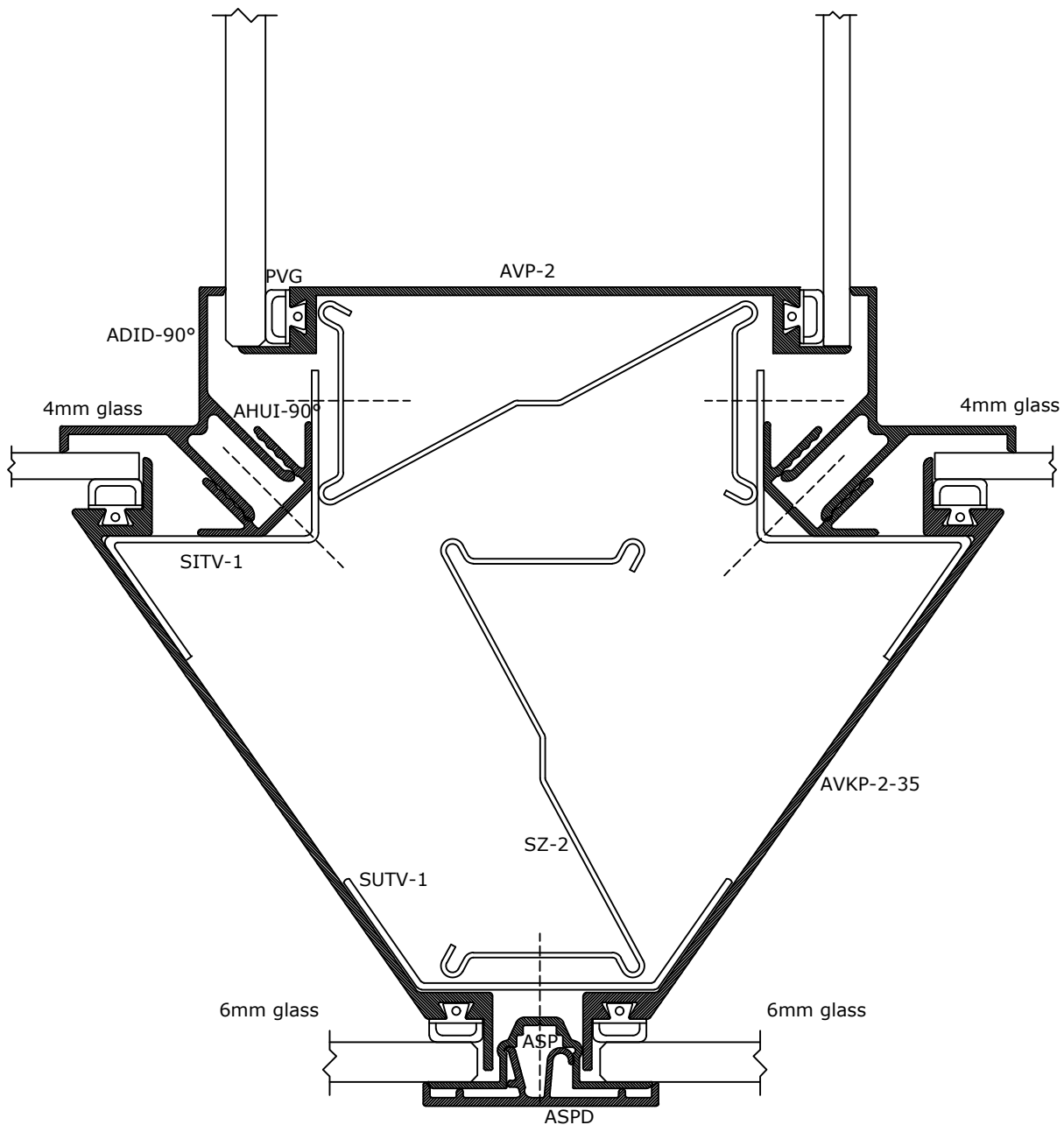

	DEKO Tlf./Tel: +45 43 55 77 11 www.deko.dk / www.deko.com	Projekt/Project: DEKO GV 1090	
	Sags Nr./Case No.:	Emne/Subject: V2F	Dato/Date:
Mål/Scale: 1:1		Revideret/Revision: 2016-10-06-VXX	Signatur Signature EBR

1090 V2H

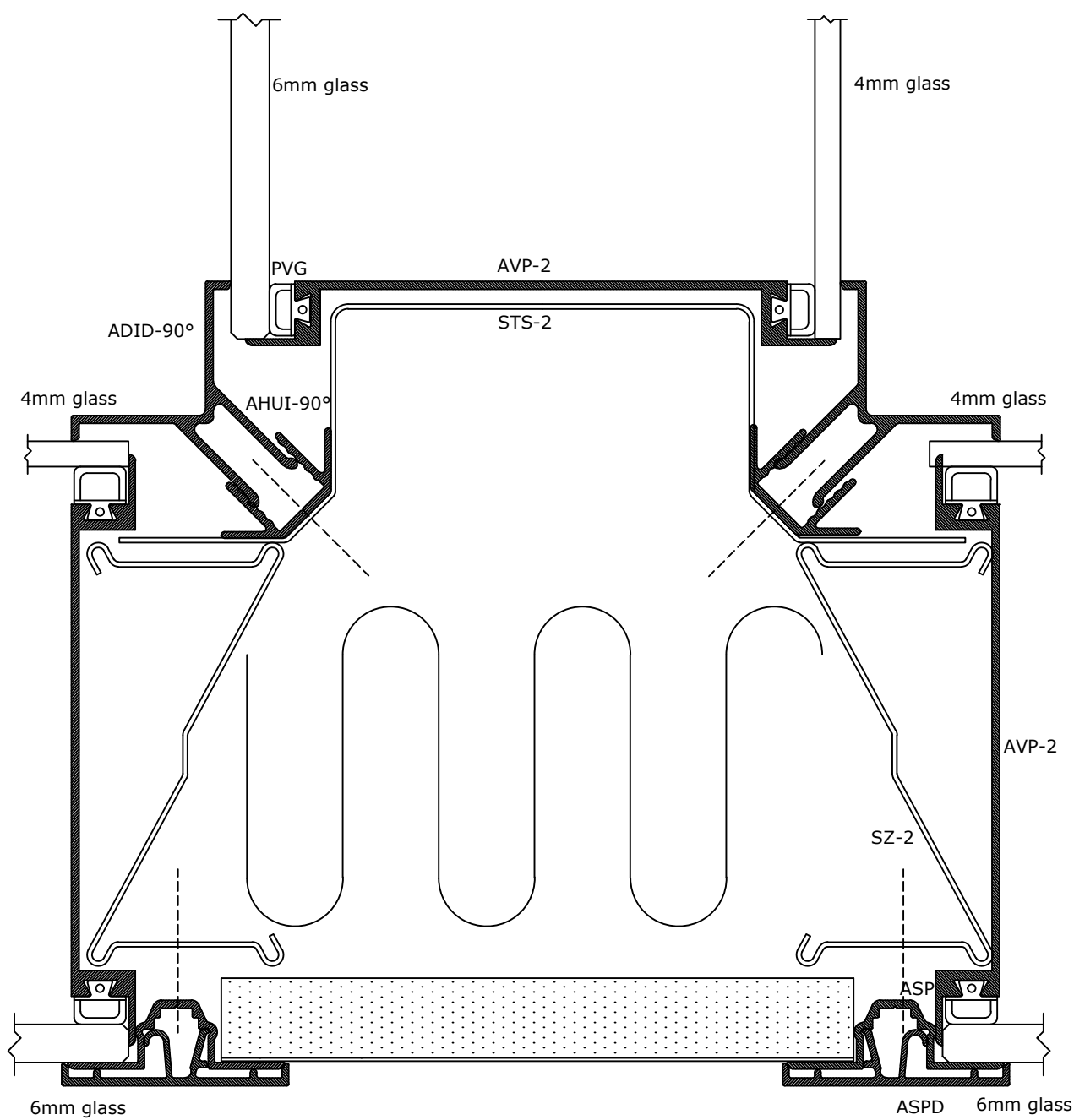

	DEKO Tlf./Tel: +45 43 55 77 11 www.deko.dk / www.deko.com	Projekt/Project: DEKO GV 1090	
	Sags Nr./Case No.:	Emne/Subject: V2H	Dato/Date:
Mål/Scale: 1:1		Revideret/Revision: 2016-10-06-VXX	Signatur Signature EBR



	DEKO Tlf./Tel: +45 43 55 77 11 www.deko.dk / www.deko.com	Projekt/Project: DEKO GV 1090	
	Sags Nr./Case No.:	Emne/Subject: V2I	Dato/Date:
Mål/Scale: 1:1		Revideret/Revision: 2016-10-06-VXX	Signatur Signature EBR

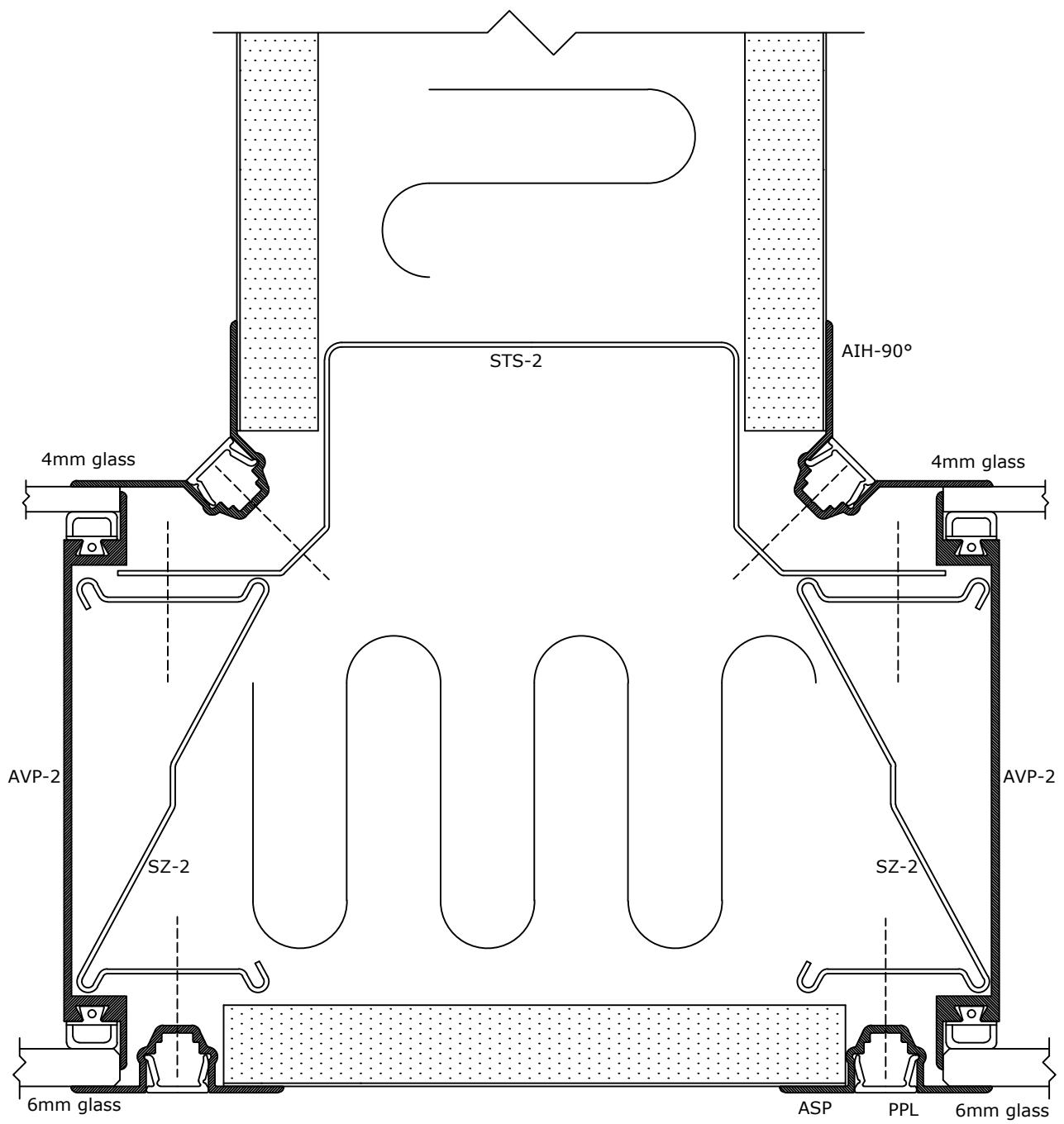

	DEKO Tlf./Tel: +45 43 55 77 11 www.deko.dk / www.deko.com	Projekt/Project: DEKO GV 1090	
	Sags Nr./Case No.: 	Emne/Subject: V2J	Dato/Date:
Mål/Scale: 1:1	 	Revideret/Revision: 2016-10-06-VXX	Signatur Signature EBR

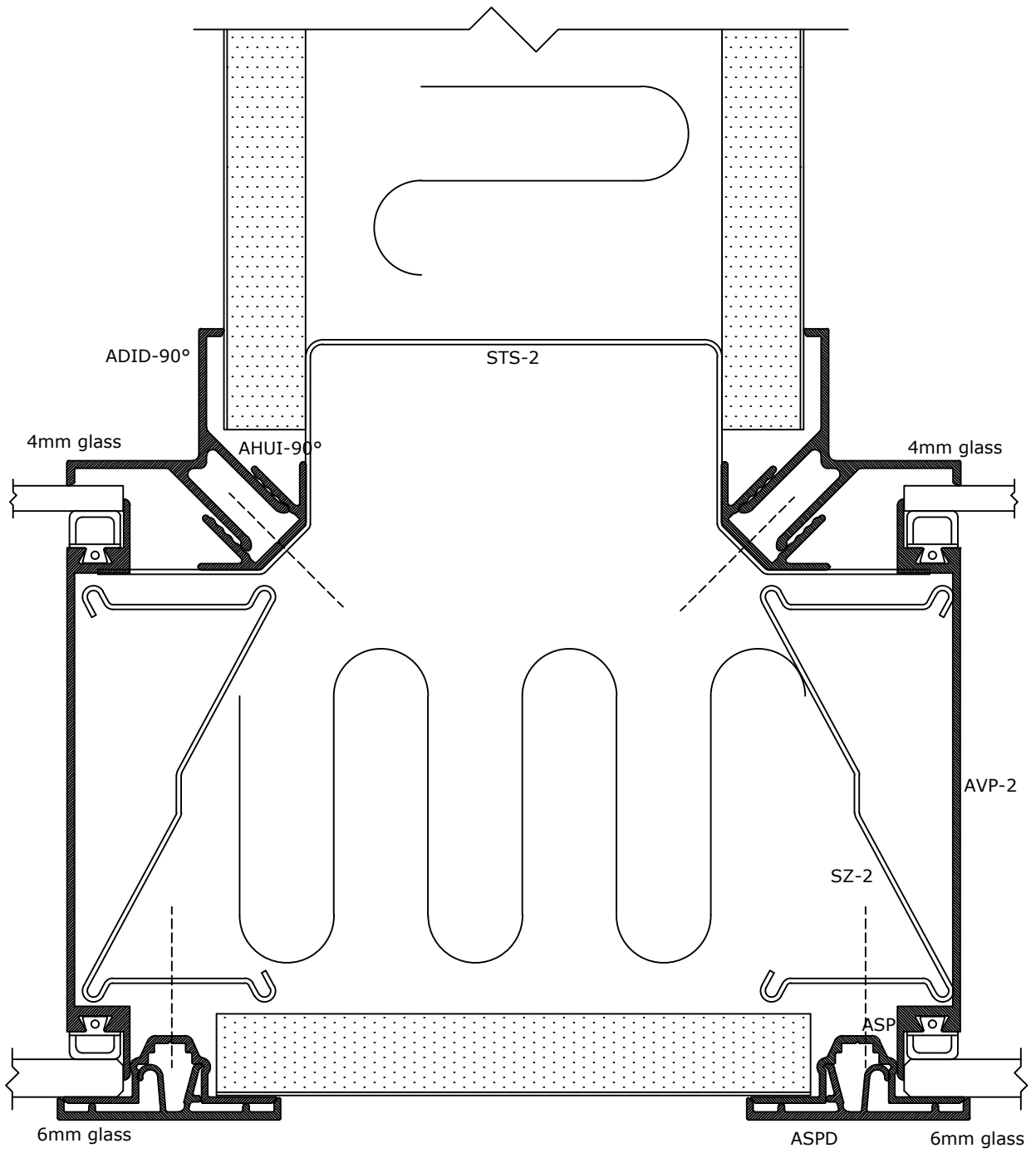

	DEKO Tlf./Tel: +45 43 55 77 11 www.deko.dk / www.deko.com	Projekt/Project: DEKO GV 1090		
	Sags Nr./Case No.: V2K	Emne/Subject:	Dato/Date:	Tegn. Nr. Sheet No. 1/1
	Mål/Scale: 1:1		Revideret/Revision: 2016-10-06-VXX	Signatur Signature EBR

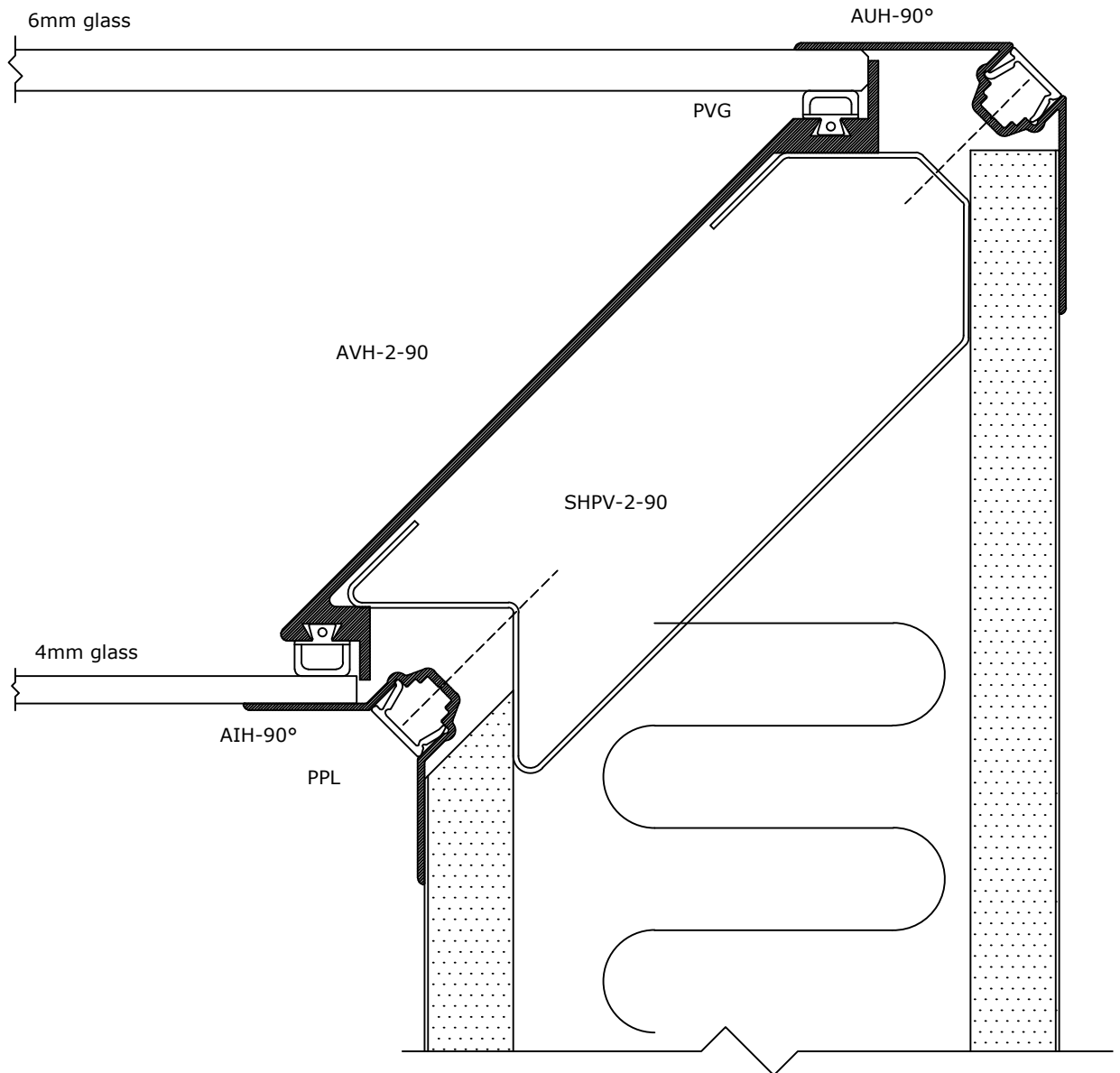

	DEKO Tlf./Tel: +45 43 55 77 11 www.deko.dk / www.deko.com	Projekt/Project: DEKO GV 1090	
	Sags Nr./Case No.:	Emne/Subject: V3C	Dato/Date:
Mål/Scale: 1:1		Revideret/Revision: 2016-10-07-VXX	Signatur Signature EBR

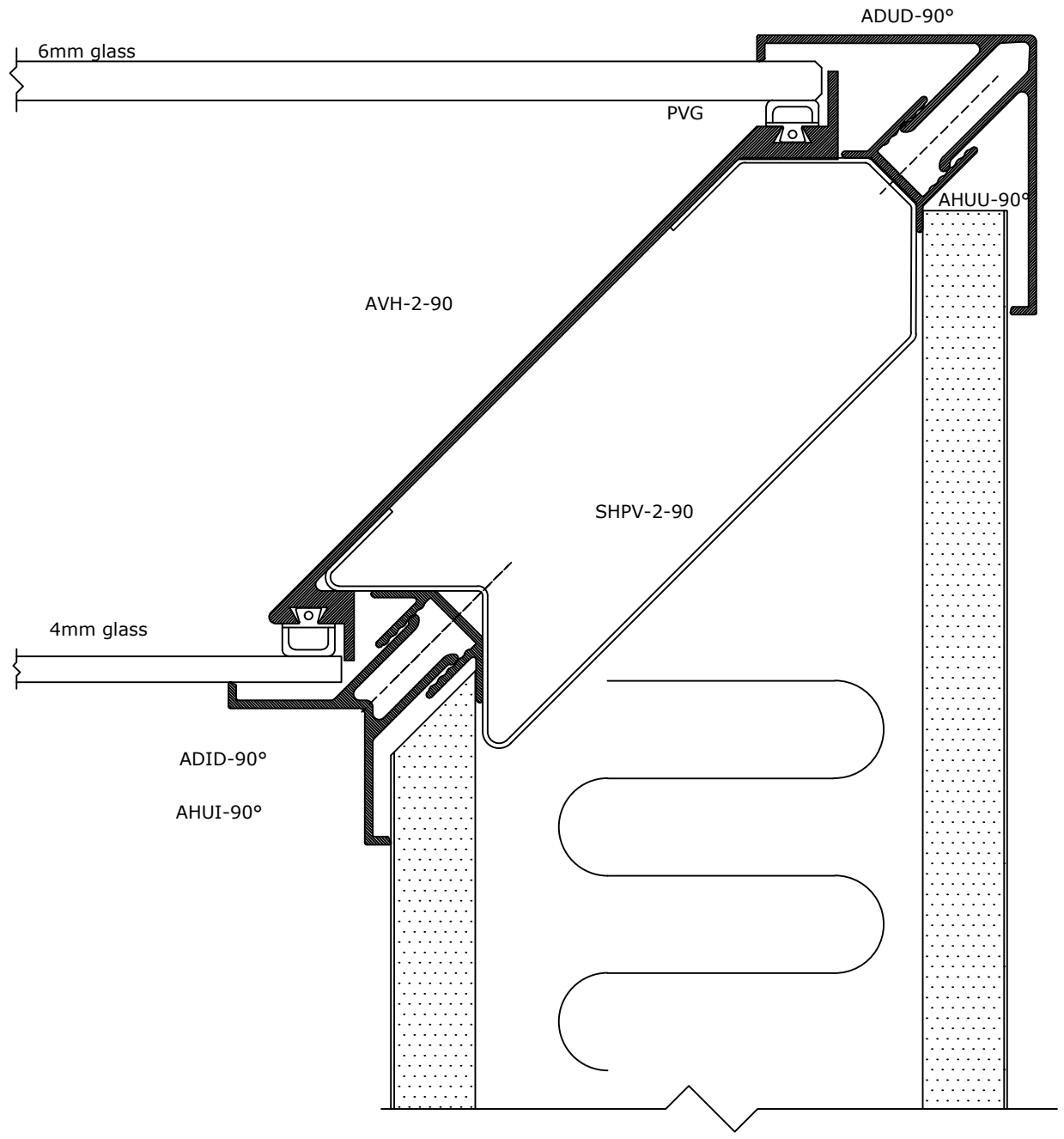

	DEKO Tlf./Tel: +45 43 55 77 11 www.deko.dk / www.deko.com	Projekt/Project: DEKO GV 1090	
	Sags Nr./Case No.: V3D	Emne/Subject:	Dato/Date:
Mål/Scale: 1:1		Revideret/Revision: 2016-10-07-VXX	Signatur Signature EBR

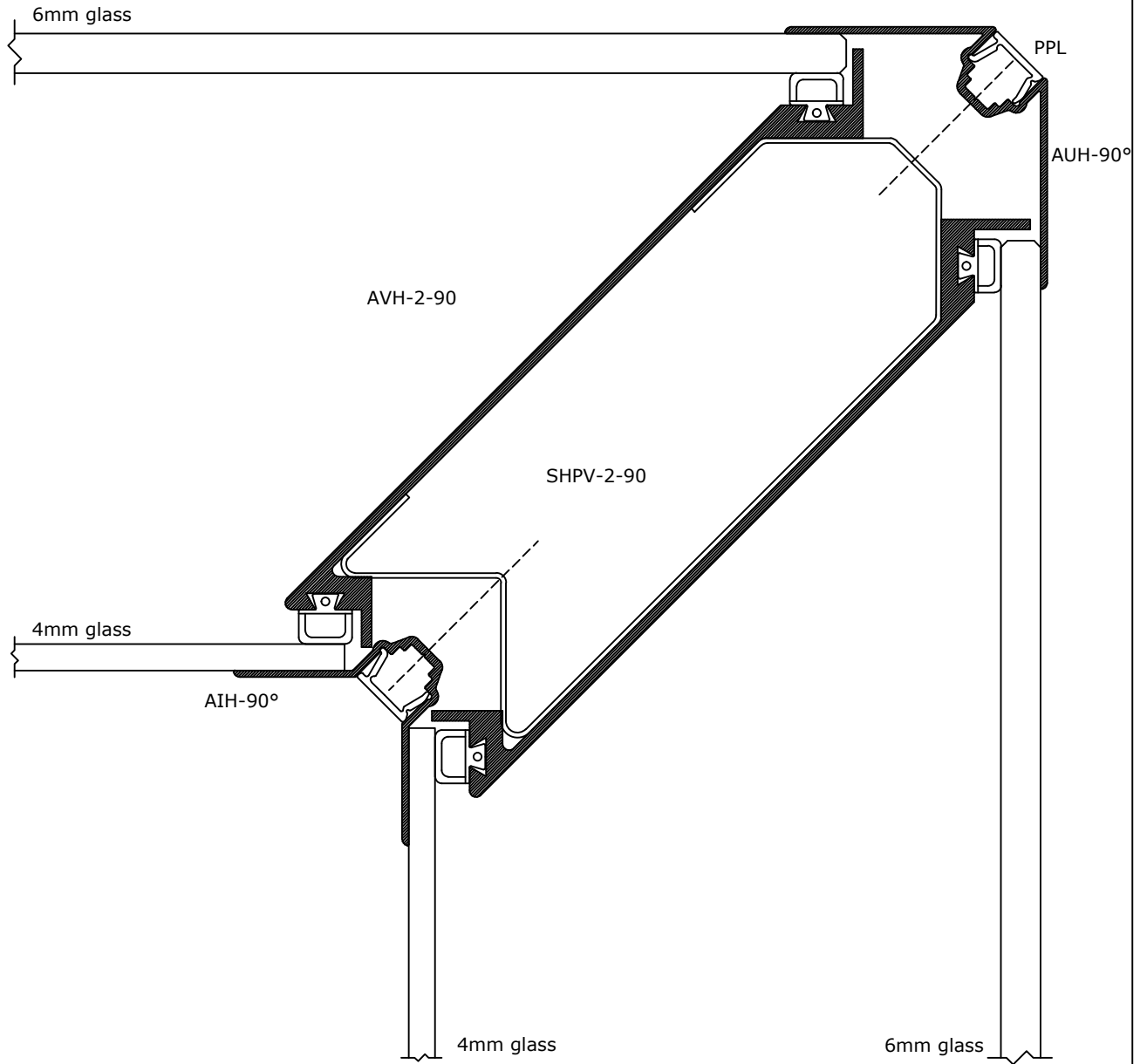

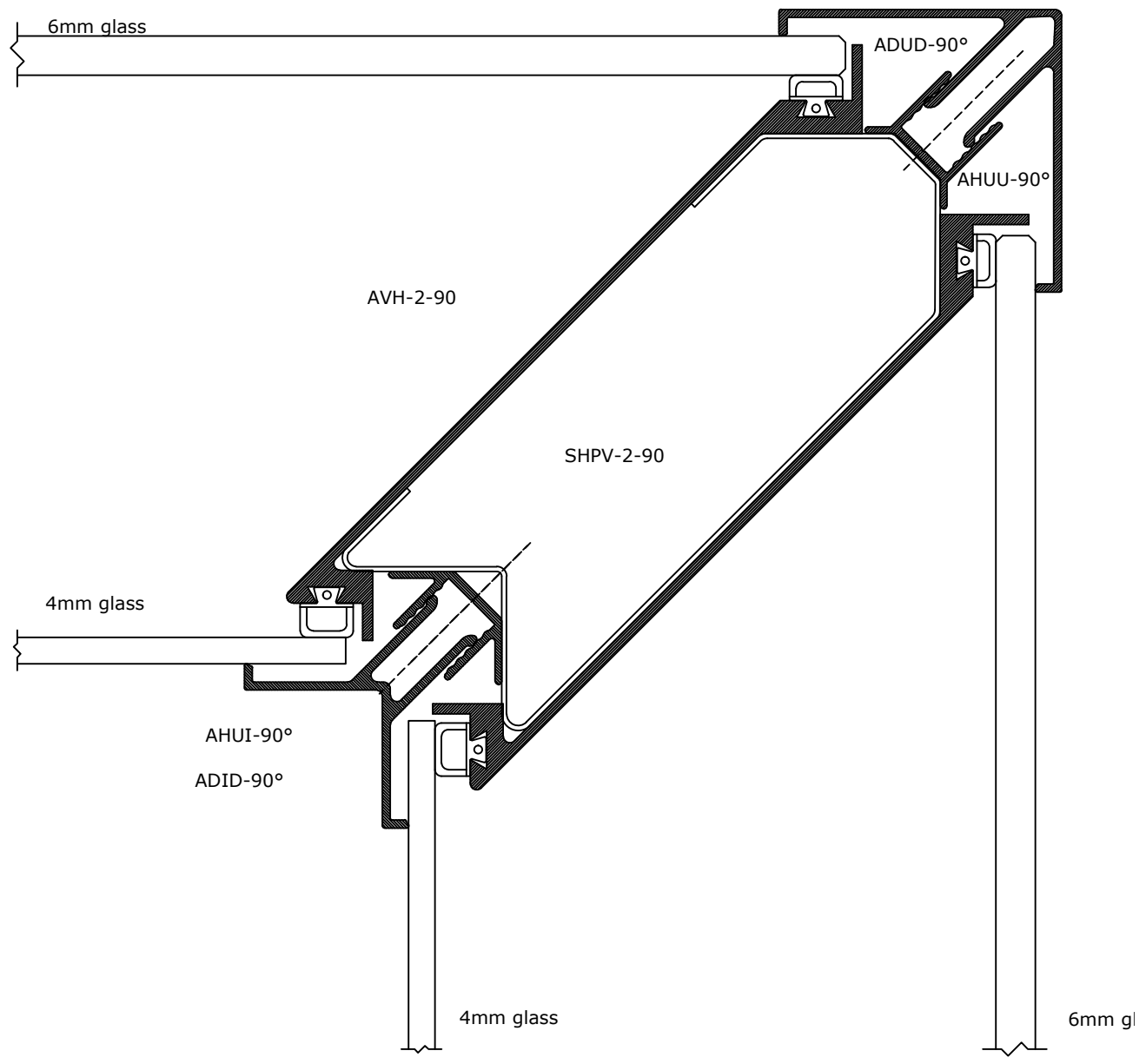

	DEKO Tlf./Tel: +45 43 55 77 11 www.deko.dk / www.deko.com	Projekt/Project: DEKO GV 1090	
	Sags Nr./Case No.:	Emne/Subject: V3E	Dato/Date:
Mål/Scale: 1:1		Revideret/Revision: 2016-10-07-VXX	Signatur Signature EBR

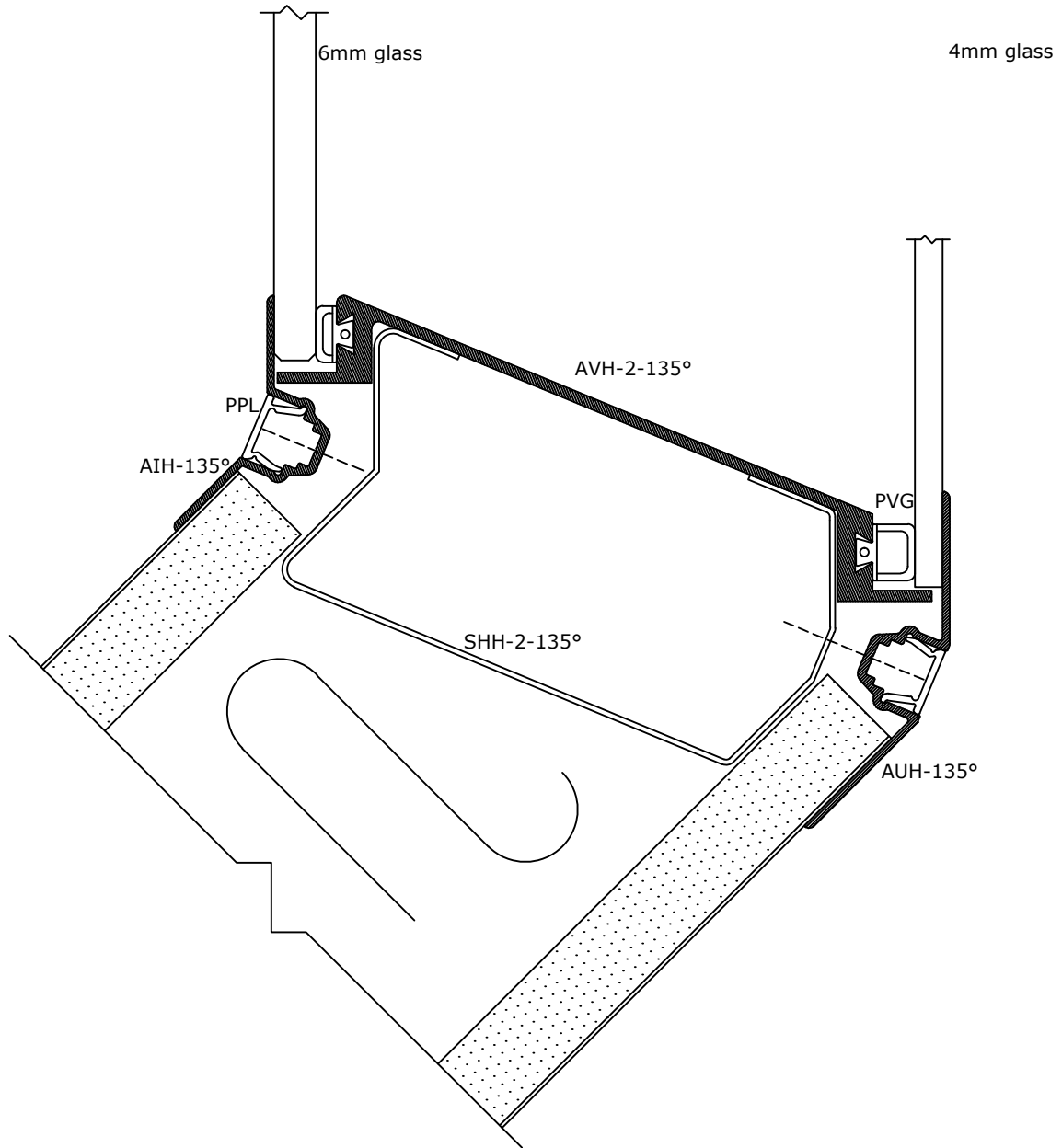

	DEKO Tlf./Tel: +45 43 55 77 11 www.deko.dk / www.deko.com	Projekt/Project: DEKO GV 1090	
	Sags Nr./Case No.:	Emne/Subject: V3F	Dato/Date:
Mål/Scale: 1:1		Revideret/Revision: 2016-10-07-VXX	Signatur Signature EBR

1090 V4C



	DEKO Tlf./Tel: +45 43 55 77 11 www.deko.dk / www.deko.com	Projekt/Project: DEKO GV 1090	
	Sags Nr./Case No.:	Emne/Subject: V4C	Dato/Date:
Mål/Scale: 1:1		Revideret/Revision: 2016-10-07-VXX	Signatur Signature EBR

1090 V4D

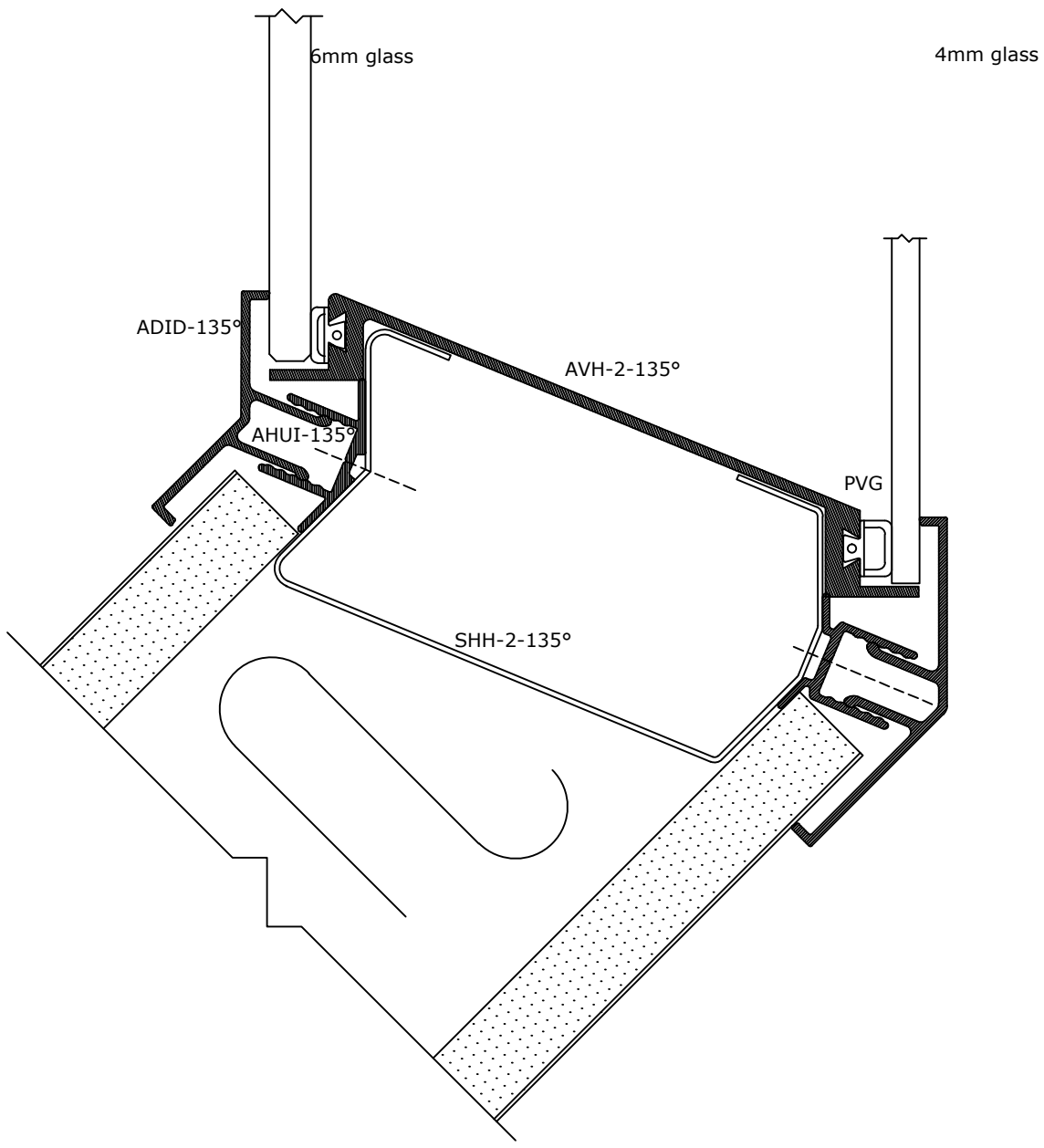

	DEKO Tlf./Tel: +45 43 55 77 11 www.deko.dk / www.deko.com	Projekt/Project: DEKO GV 1090	
	Sags Nr./Case No.:	Emne/Subject: V4D	Dato/Date:
Mål/Scale: 1:1		Revideret/Revision: 2016-10-07-VXX	Signatur Signature EBR

1090 V4E

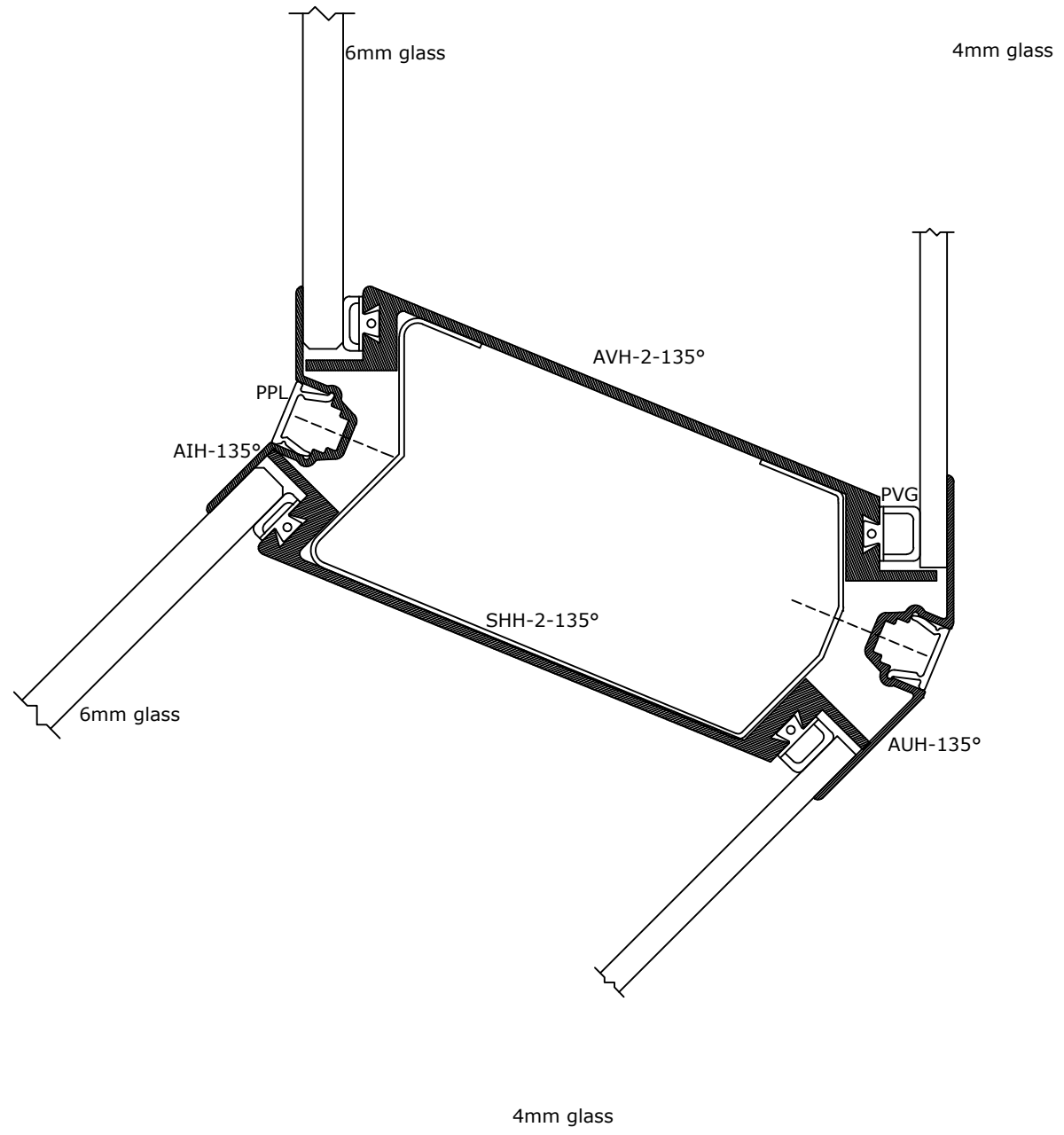

	DEKO Tlf./Tel: +45 43 55 77 11 www.deko.dk / www.deko.com	Projekt/Project: DEKO GV 1090	
	Sags Nr./Case No.:	Emne/Subject: V4E	Dato/Date:
Mål/Scale: 1:1		Revideret/Revision: 2016-10-07-VXX	Signatur Signature EBR

1090 V4F

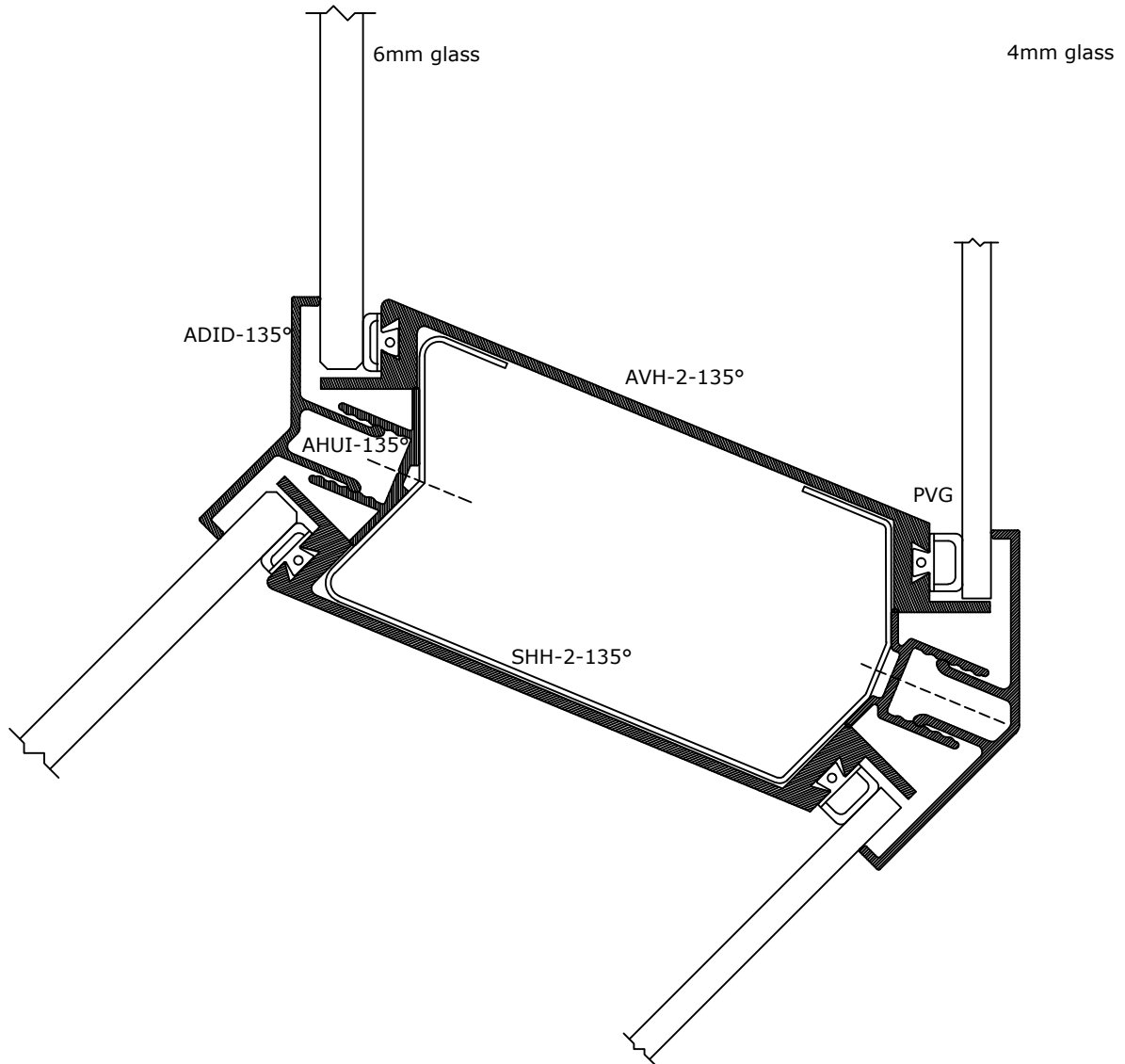

	DEKO Tlf./Tel: +45 43 55 77 11 www.deko.dk / www.deko.com	Projekt/Project: DEKO GV 1090	
	Sags Nr./Case No.:	Emne/Subject: V4F	Dato/Date:
Mål/Scale: 1:1		Revideret/Revision: 2016-10-07-VXX	Signatur Signature EBR

1090 V5C

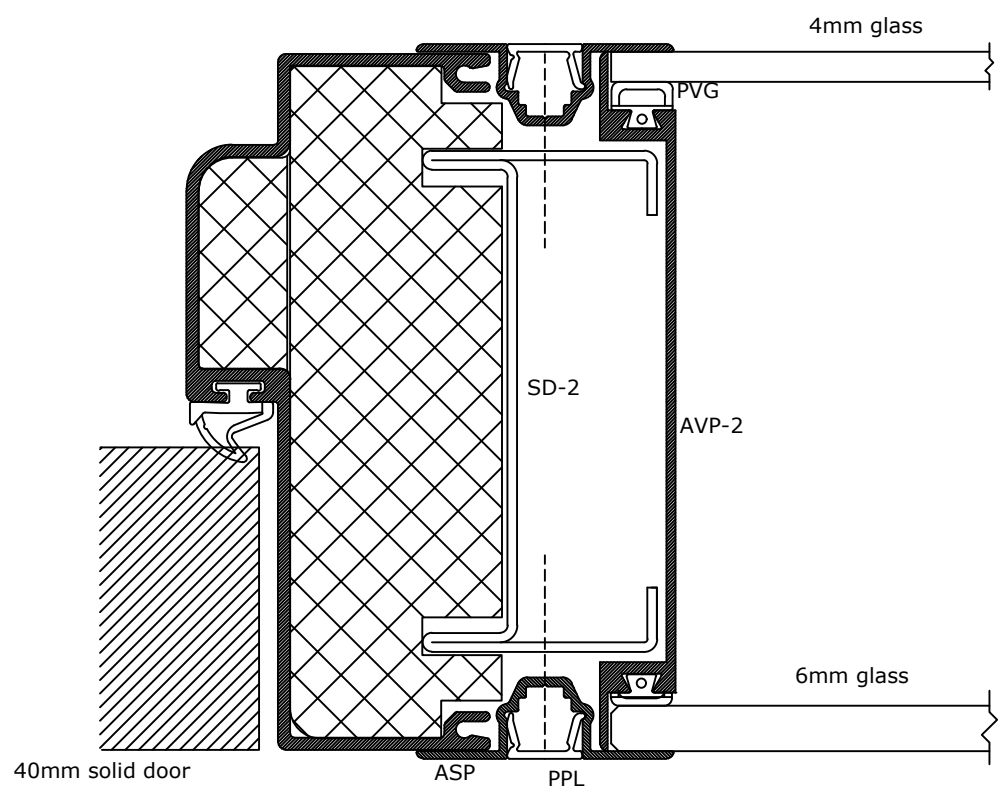

	DEKO Tlf./Tel: +45 43 55 77 11 www.deko.dk / www.deko.com	Projekt/Project: DEKO GV 1090	
	Sags Nr./Case No.:	Emne/Subject: V5C	Dato/Date:
Mål/Scale: 1:1		Revideret/Revision: 2016-10-07-VXX	Signatur Signature EBR

1090 V5D

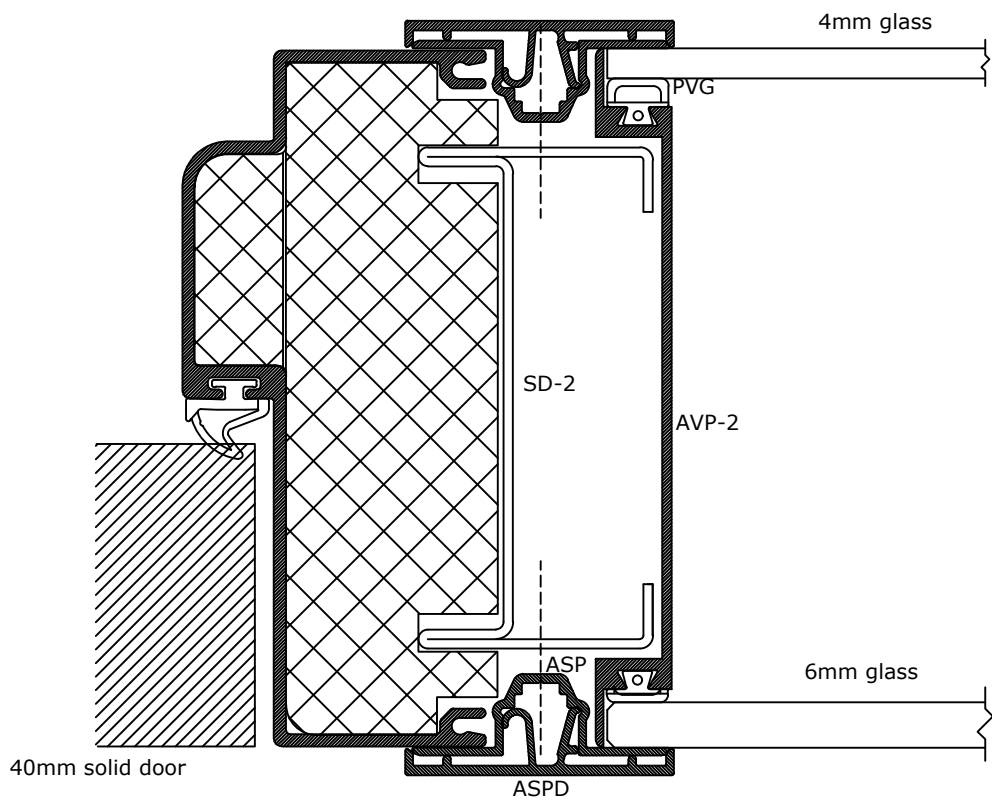

	DEKO Tlf./Tel: +45 43 55 77 11 www.deko.dk / www.deko.com	Projekt/Project: DEKO GV 1090	
	Sags Nr./Case No.:	Emne/Subject: V5D	Dato/Date:
Mål/Scale: 1:1		Revideret/Revision: 2016-10-07-VXX	Signatur Signature EBR

1090 V5F

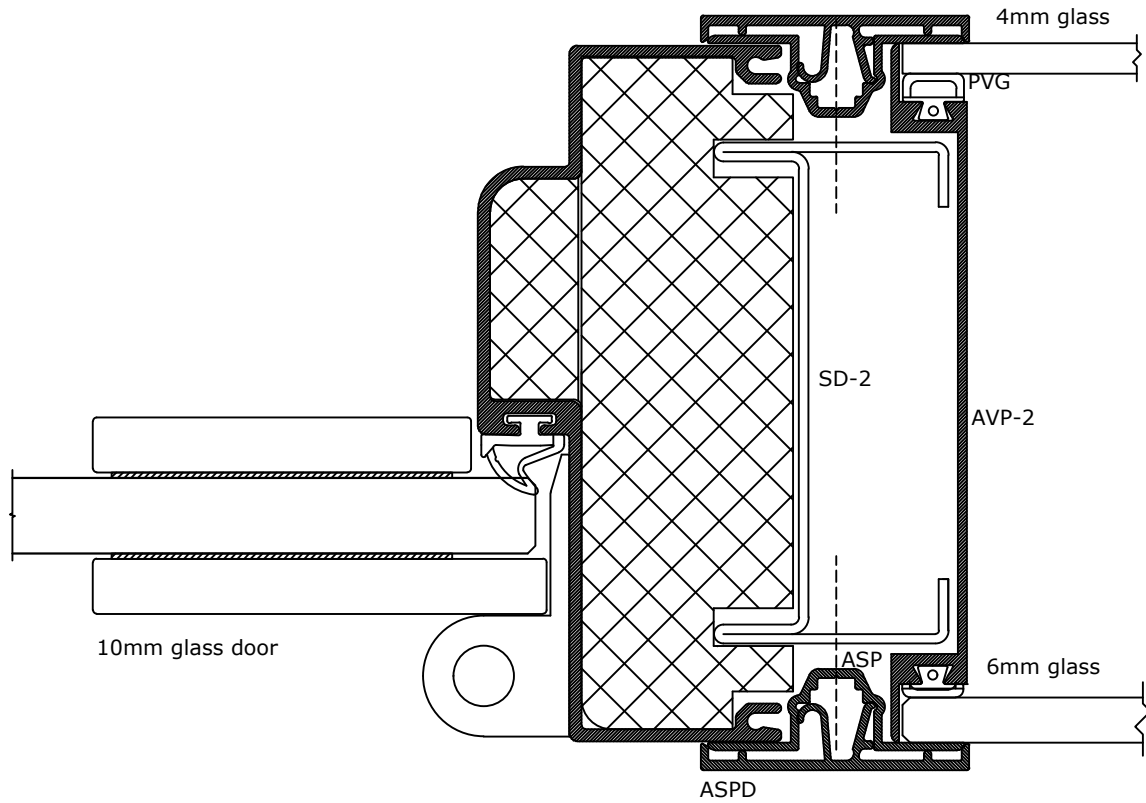

	DEKO Tlf./Tel: +45 43 55 77 11 www.deko.dk / www.deko.com	Projekt/Project: DEKO GV 1090	
	Sags Nr./Case No.:	Emne/Subject: V5F	Dato/Date:
Mål/Scale: 1:1		Revideret/Revision: 2016-10-07-VXX	Signatur Signature EBR

1090 V5G

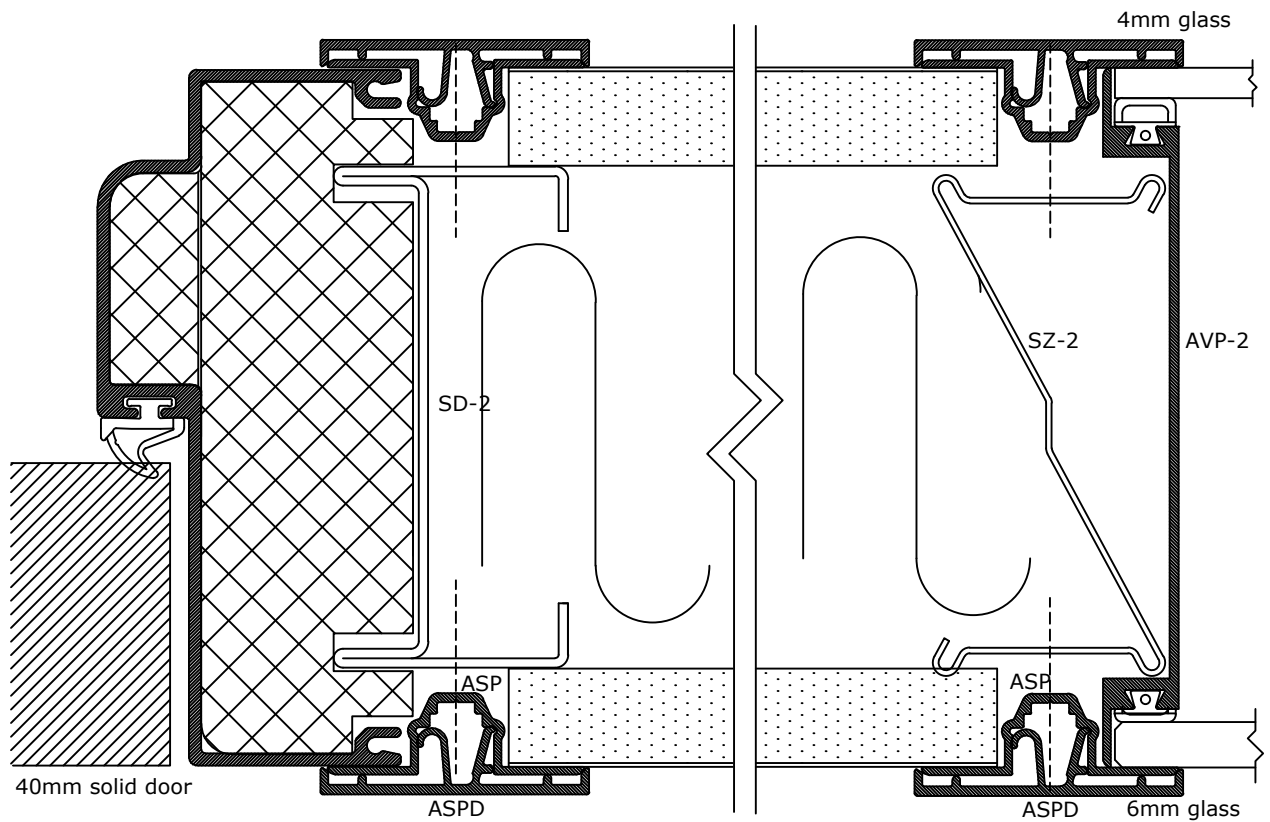

	DEKO Tlf./Tel: +45 43 55 77 11 www.deko.dk / www.deko.com	Projekt/Project: DEKO GV 1090	
	Sags Nr./Case No.:	Emne/Subject: V5G	Dato/Date:
Mål/Scale: 1:1		Revideret/Revision: 2016-10-07-VXX	Signatur Signature EBR

1090 V5H

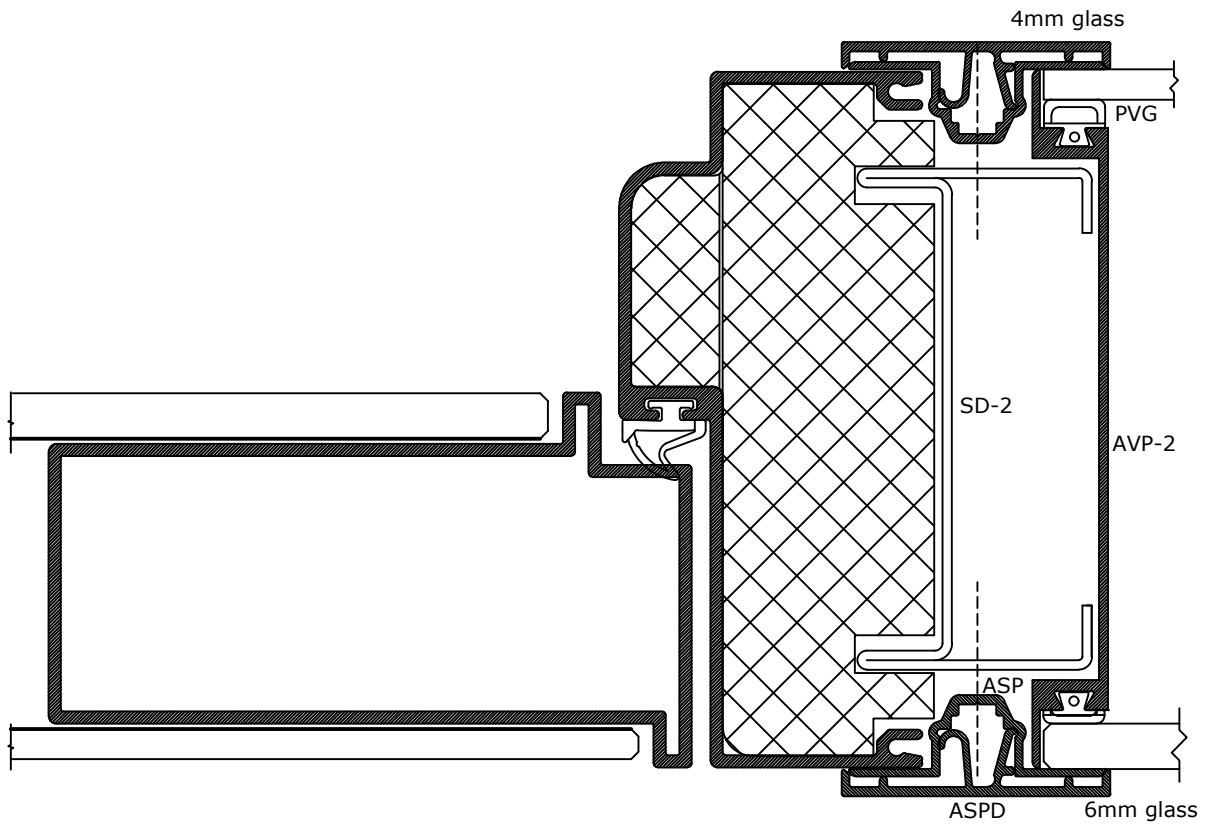

	DEKO Tlf./Tel: +45 43 55 77 11 www.deko.dk / www.deko.com	Projekt/Project: DEKO GV 1090	
	Sags Nr./Case No.:	Emne/Subject: V5H	Dato/Date:
Mål/Scale: 1:1		Revideret/Revision: 2016-10-07-VXX	Signatur Signature EBR

1090 V7C

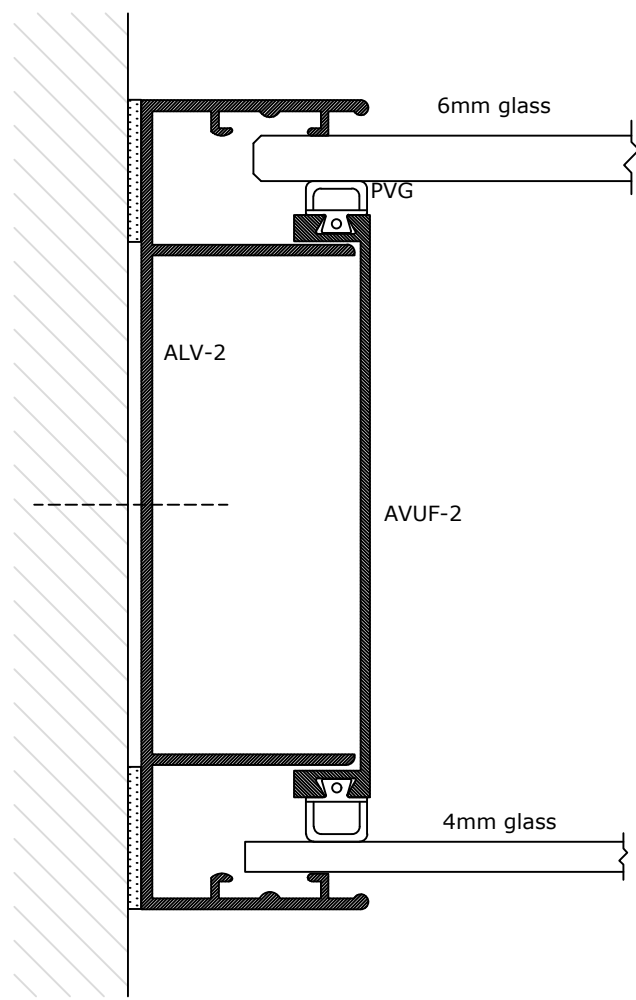

	DEKO Tlf./Tel: +45 43 55 77 11 www.deko.dk / www.deko.com	Projekt/Project: DEKO GV 1090	
	Sags Nr./Case No.:	Emne/Subject: V7C	Dato/Date:
Mål/Scale: 1:1		Revideret/Revision: 2016-10-07-VXX	Signatur Signature EBR

1090 V7D

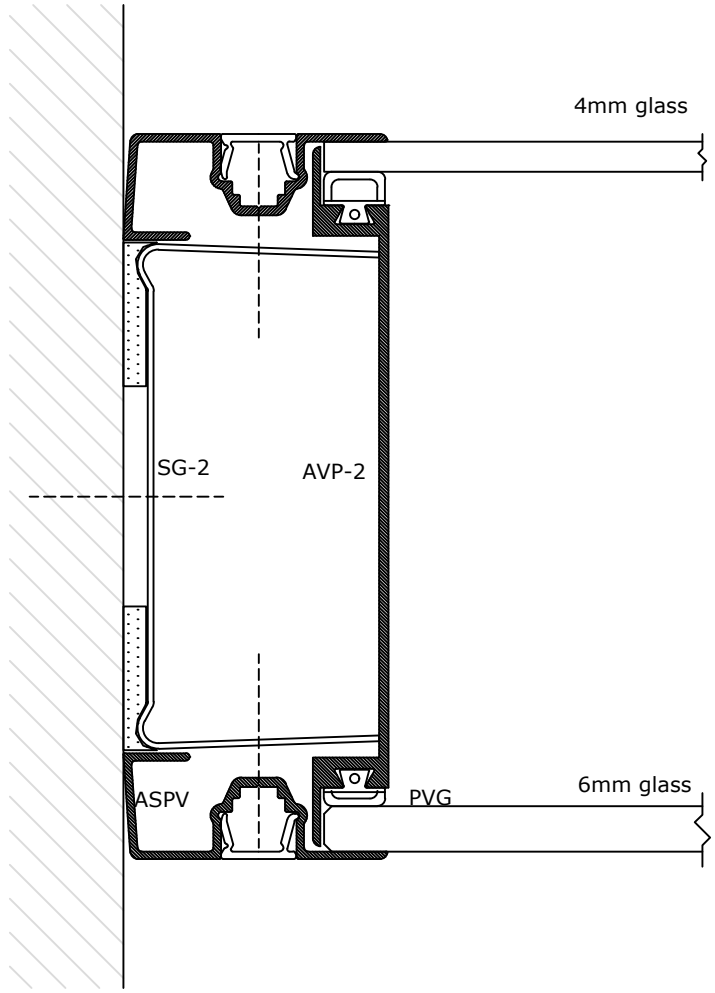

	DEKO Tlf./Tel: +45 43 55 77 11 www.deko.dk / www.deko.com	Projekt/Project: DEKO GV 1090	
	Sags Nr./Case No.:	Emne/Subject: V7D	Dato/Date:
Mål/Scale: 1:1		Revideret/Revision: 2016-10-07-VXX	Signatur Signature EBR

1090 V7E

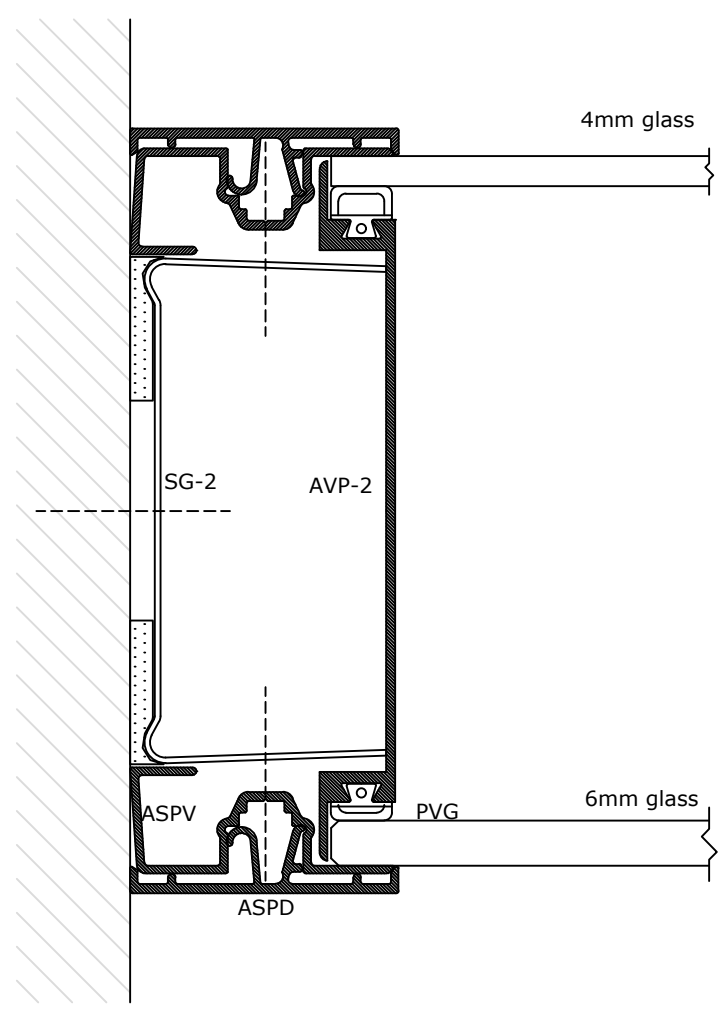

	DEKO Tlf./Tel: +45 43 55 77 11 www.deko.dk / www.deko.com	Projekt/Project: DEKO GV 1090	
	Sags Nr./Case No.:	Emne/Subject: V7E	Dato/Date:
Mål/Scale: 1:1		Revideret/Revision: 2016-10-07-VXX	Signatur Signature EBR

1090 V7G

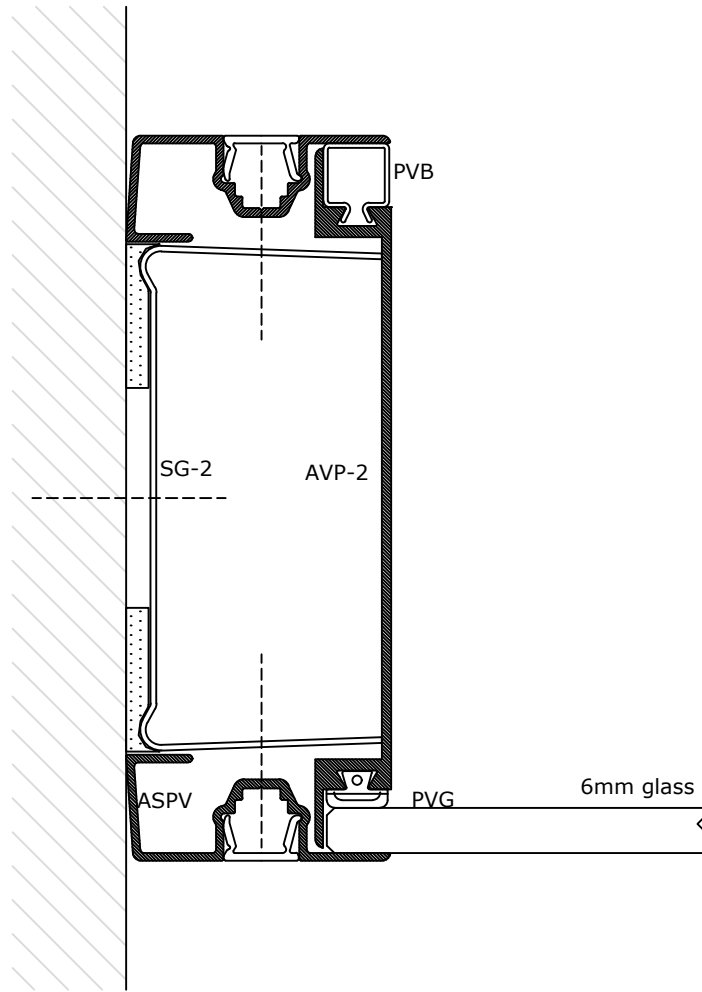

	DEKO Tlf./Tel: +45 43 55 77 11 www.deko.dk / www.deko.com	Projekt/Project: DEKO GV 1090	
	Sags Nr./Case No.:	Emne/Subject: V7G	Dato/Date:
Mål/Scale: 1:1		Revideret/Revision: 2016-10-07-VXX	Signatur Signature EBR

1090 V8A

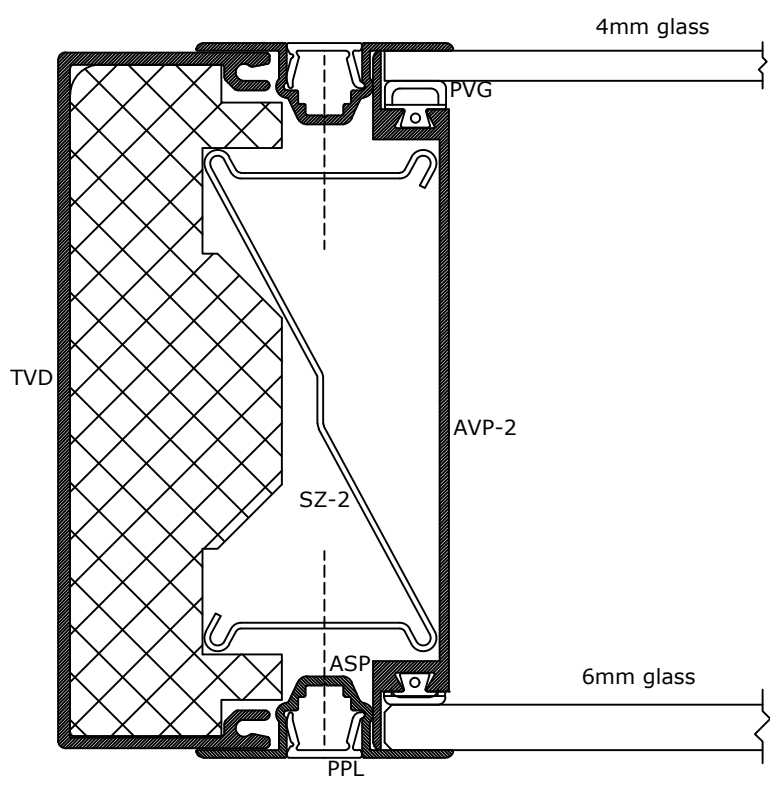

	DEKO Tlf./Tel: +45 43 55 77 11 www.deko.dk / www.deko.com	Projekt/Project: DEKO GV 1090	
	Sags Nr./Case No.:	Emne/Subject: V8A	Dato/Date:
Mål/Scale: 1:1		Revideret/Revision: 2016-10-07-VXX	Signatur Signature EBR

1090 V8B

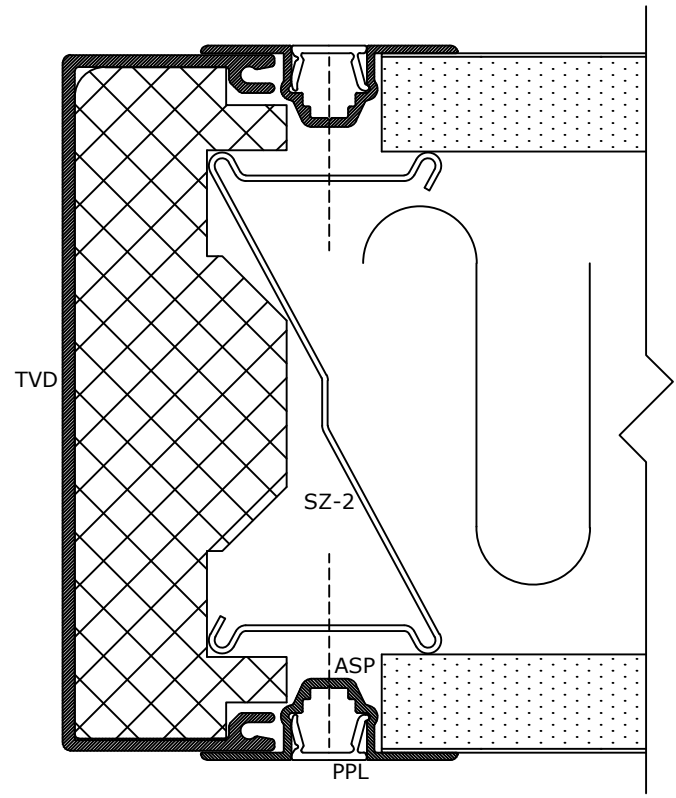

	DEKO Tlf./Tel: +45 43 55 77 11 www.deko.dk / www.deko.com	Projekt/Project: DEKO GV 1090	
	Sags Nr./Case No.:	Emne/Subject: V8B	Dato/Date:
Mål/Scale: 1:1		Revideret/Revision: 2016-10-07-VXX	Signatur Signature EBR

1090 V8C

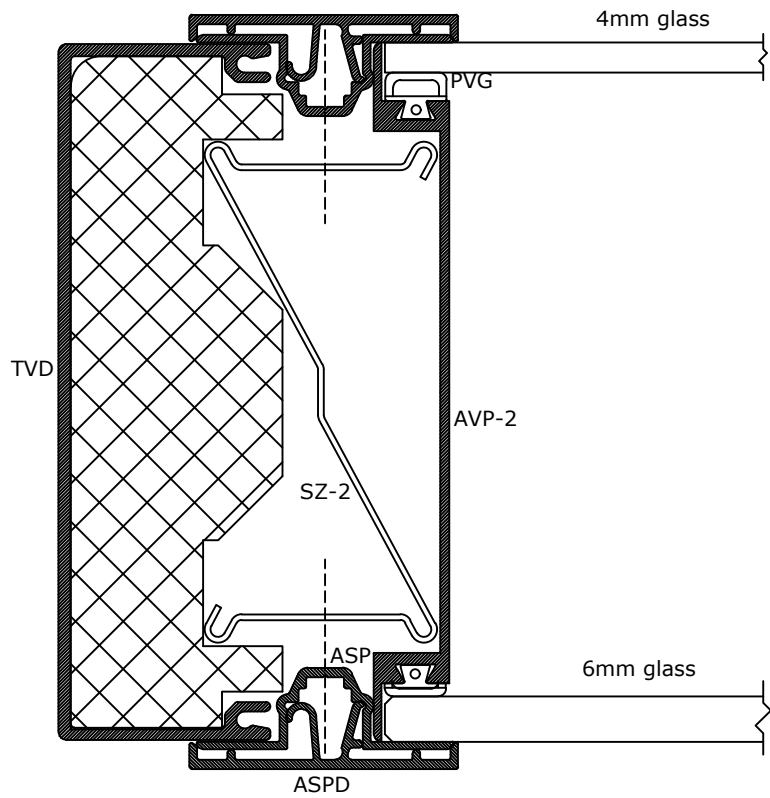

	DEKO Tlf./Tel: +45 43 55 77 11 www.deko.dk / www.deko.com	Projekt/Project: DEKO GV 1090	
	Sags Nr./Case No.:	Emne/Subject: V8C	Dato/Date:
Mål/Scale: 1:1		Revideret/Revision: 2016-10-07-VXX	Signatur Signature EBR

1090 V9B

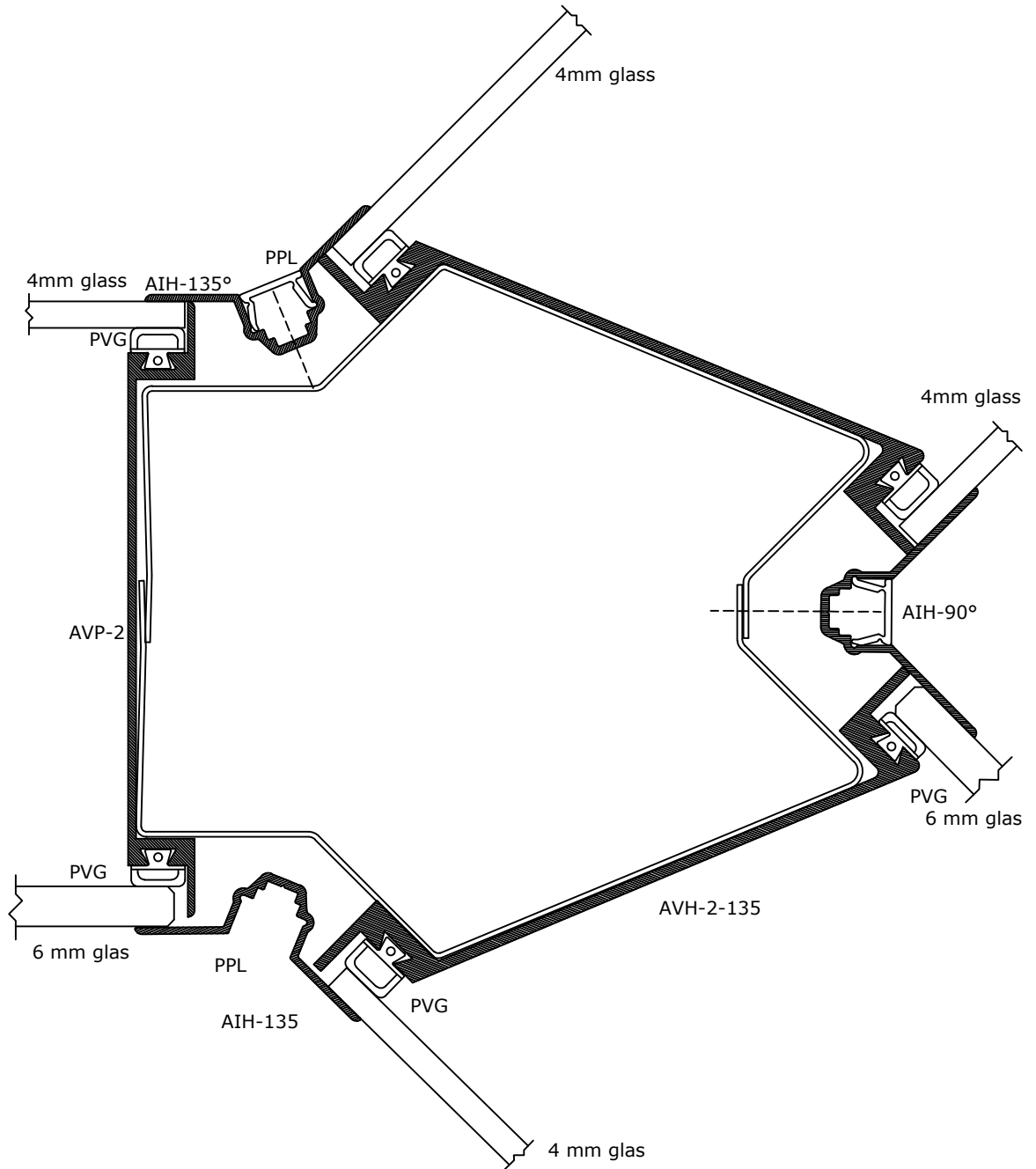

	DEKO Tlf./Tel: +45 43 55 77 11 www.deko.dk / www.deko.com	Projekt/Project: DEKO GV 1090	
	Sags Nr./Case No.: 	Emne/Subject: V9B	Dato/Date:
Mål/Scale: 1:1	 	Revideret/Revision: 2016-10-07-VXX	Signatur Signature EBR

1090 V9C

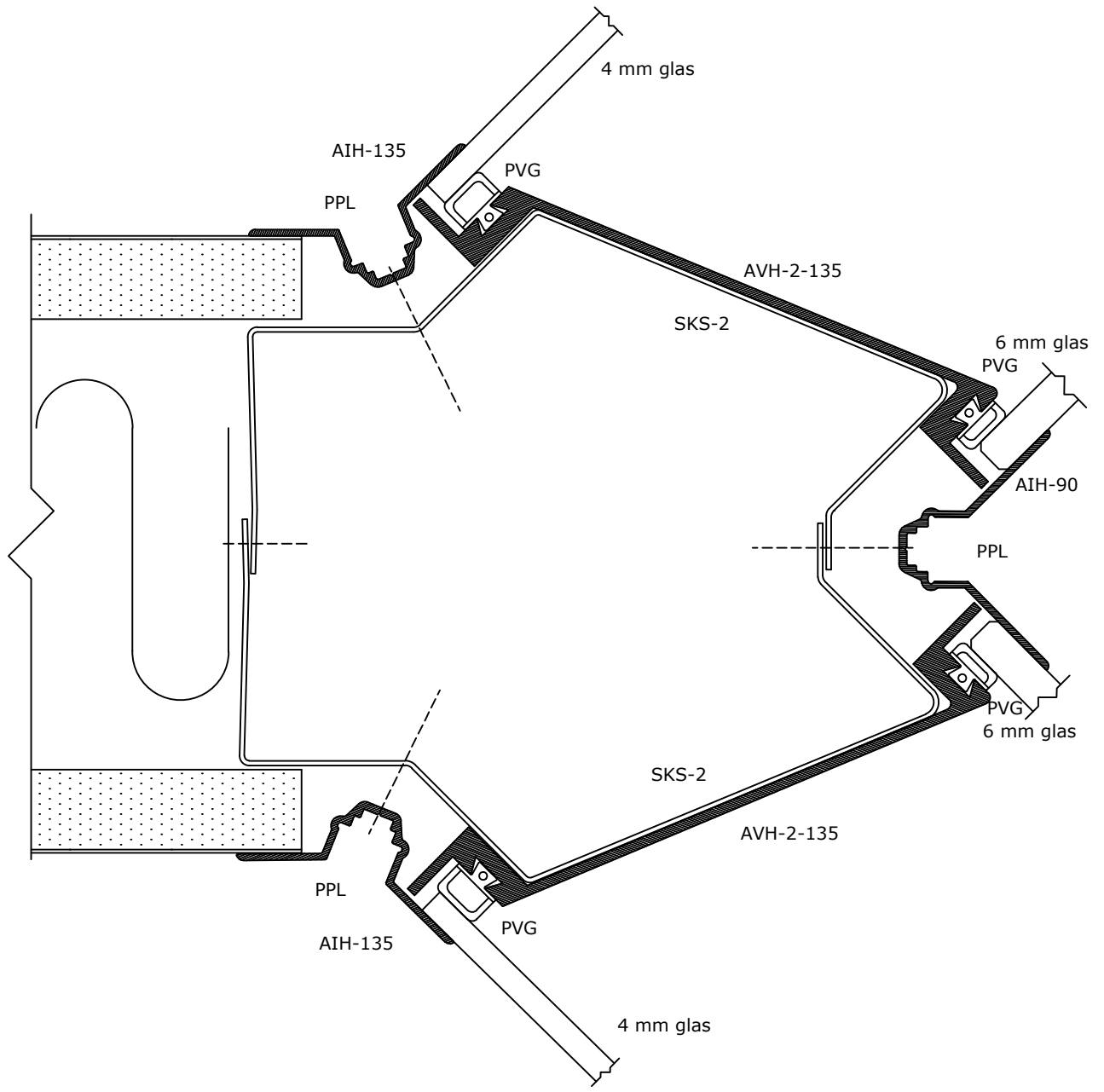

	DEKO Tlf./Tel: +45 43 55 77 11 www.deko.dk / www.deko.com	Projekt/Project: DEKO GV 1090	
	Sags Nr./Case No.:	Emne/Subject: V9C	Dato/Date:
Mål/Scale: 1:1		Revideret/Revision: 2016-10-07-VXX	Signatur Signature EBR

1090 V9D

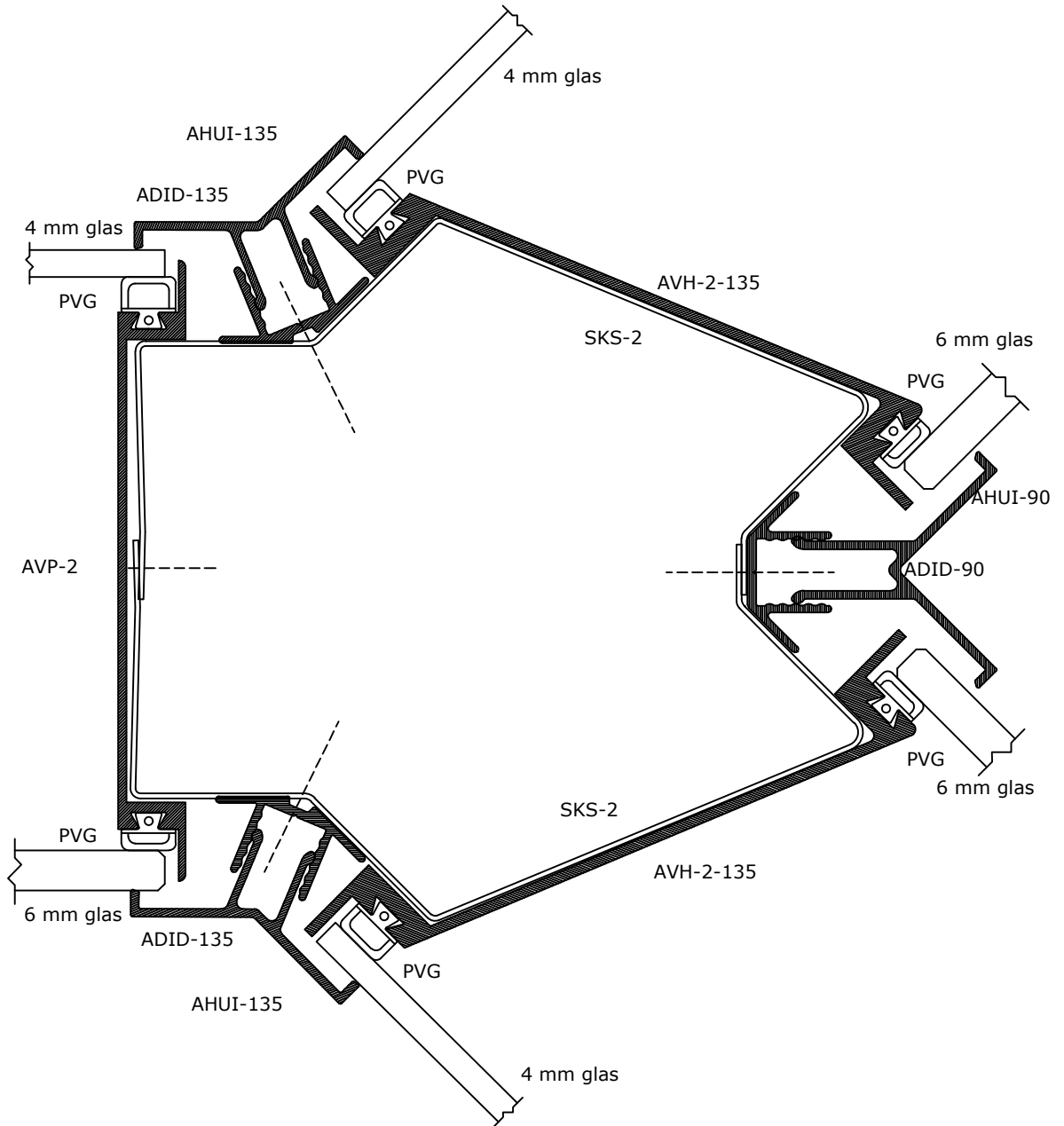

	DEKO Tlf./Tel: +45 43 55 77 11 www.deko.dk / www.deko.com	Projekt/Project: DEKO GV 1090	
	Sags Nr./Case No.:	Emne/Subject: V9D	Dato/Date:
Mål/Scale: 1:1		Revideret/Revision: 2016-10-07-VXX	Signatur Signature EBR

1090 V9E

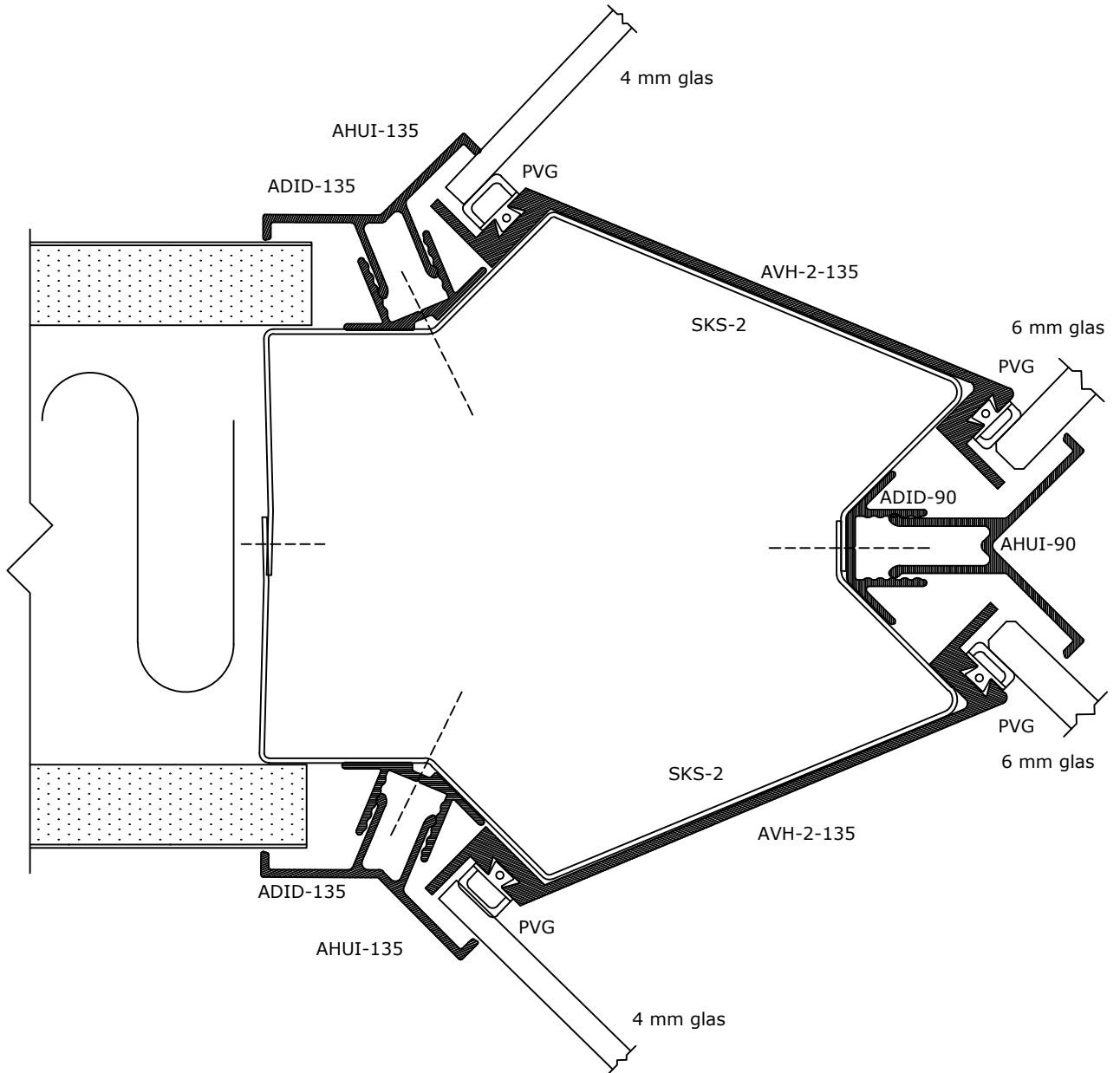

	DEKO Tlf./Tel: +45 43 55 77 11 www.deko.dk / www.deko.com	Projekt/Project: DEKO GV 1090	
	Sags Nr./Case No.:	Emne/Subject: V9E	Dato/Date:
Mål/Scale: 1:1		Revideret/Revision: 2016-10-07-VXX	Signatur Signature EBR