

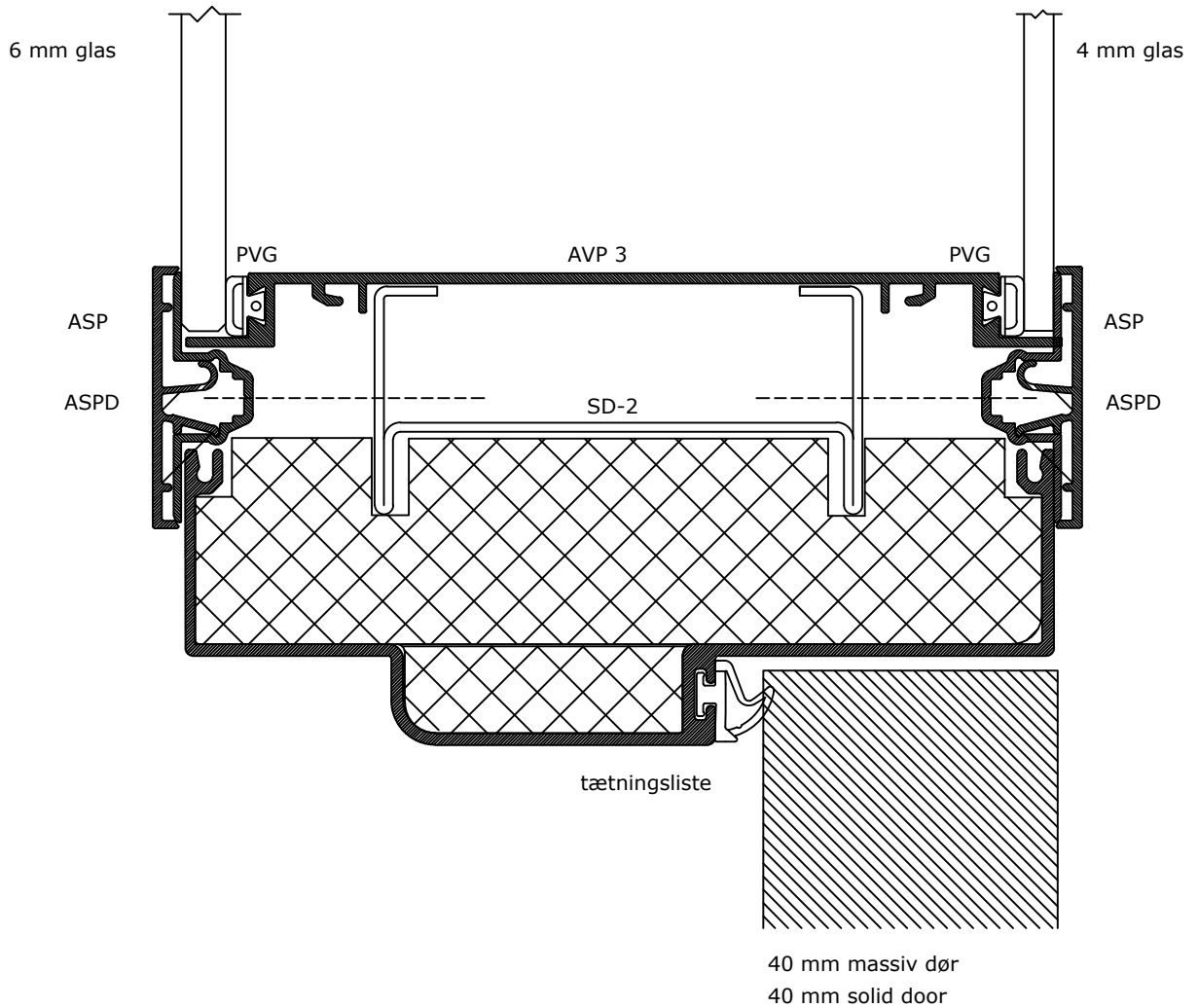

	DEKO Tlf./Tel: +45 43 55 77 11 www.deko.dk / www.deko.com	Projekt/Project: DEKO GV 1290	
	Sags Nr./Case No.: L4C	Emne/Subject: L4C	Dato/Date: 2016-10-07-VXX
Mål/Scale: 1:1		Revideret/Revision: 2016-10-07-VXX	Signatur Signature XX



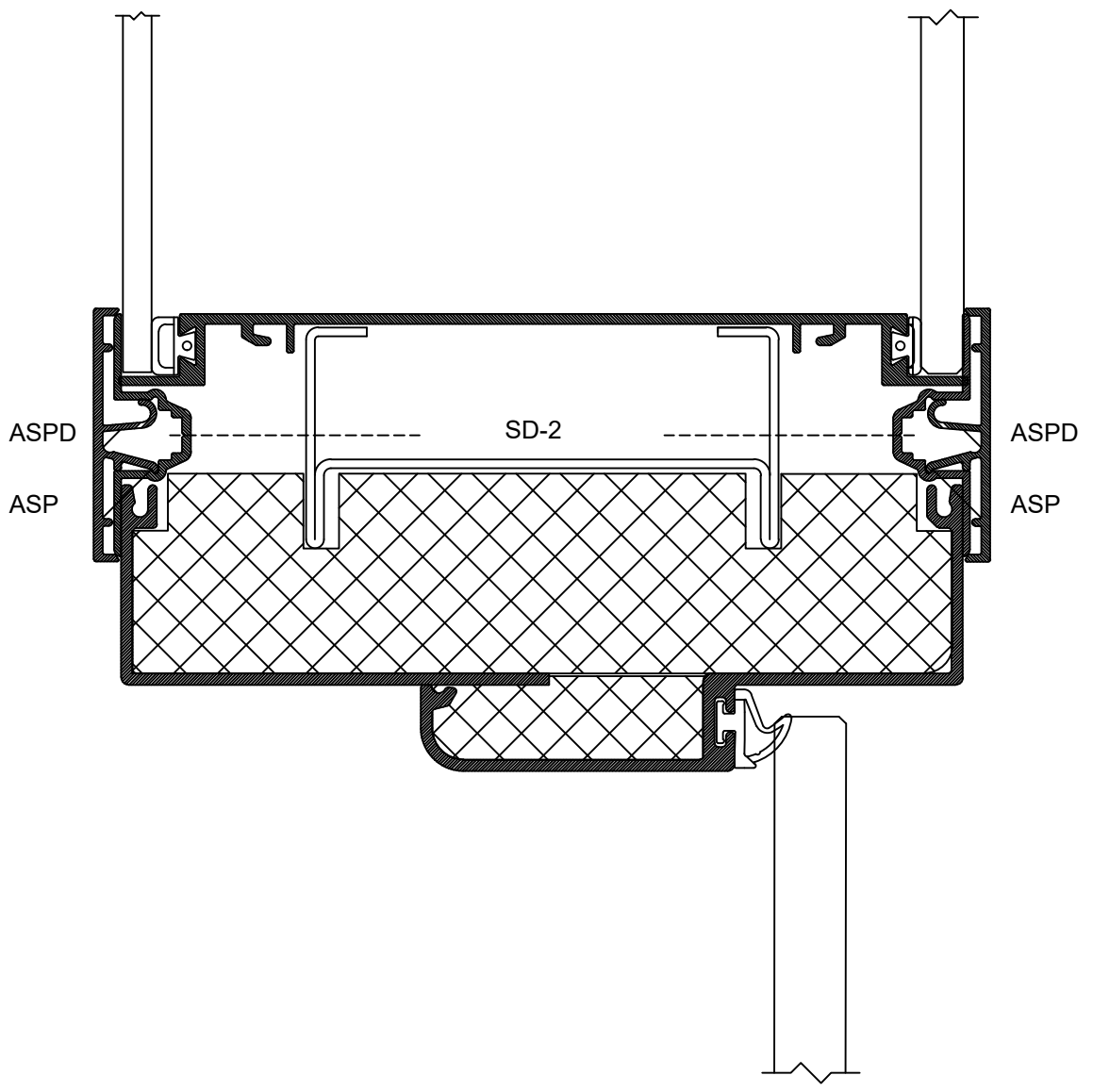

	DEKO Tlf./Tel: +45 43 55 77 11 www.deko.dk / www.deko.com	Projekt/Project: DEKO GV 1290	
	Sags Nr./Case No.: L4D	Emne/Subject: L4D	Dato/Date: 2016-10-07-VXX
Mål/Scale: 1:1		Revideret/Revision: 2016-10-07-VXX	Signatur Signature XX

1290 L4F

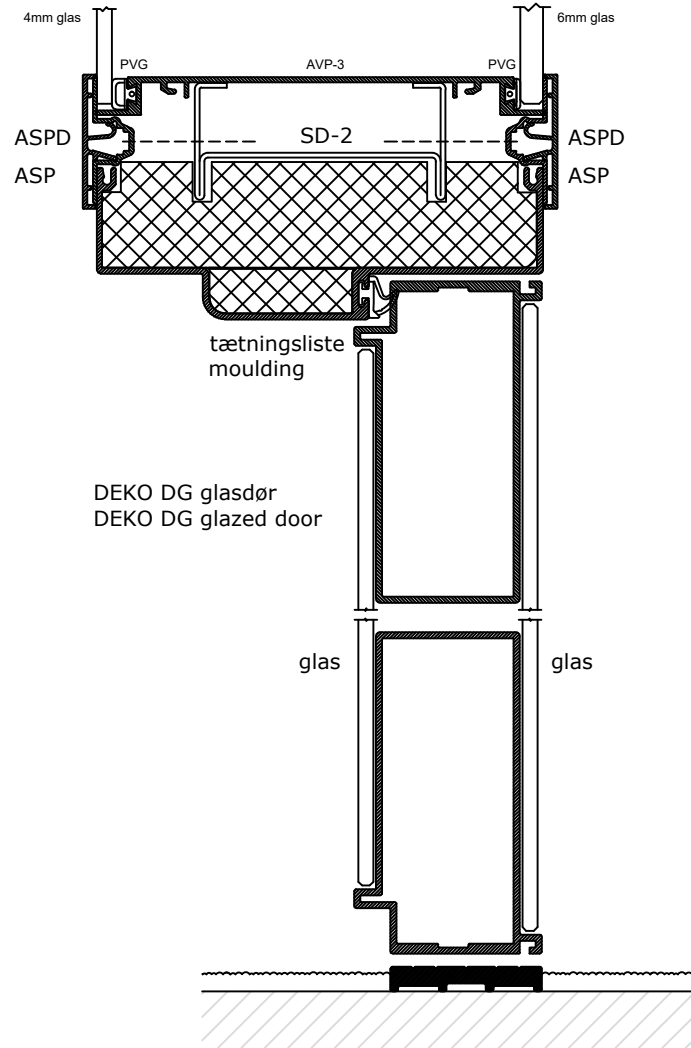

	DEKO Tlf./Tel: +45 43 55 77 11 www.deko.dk / www.deko.com	Projekt/Project: DEKO GV 1290	
	Sags Nr./Case No.:	Emne/Subject: L4F	Dato/Date:
Mål/Scale: 1:1		Revideret/Revision: 2016-10-07-VXX	Signatur Signature XX



	DEKO Tlf./Tel: +45 43 55 77 11 www.deko.dk / www.deko.com	Projekt/Project: DEKO GV 1290	
	Sags Nr./Case No.: L4G	Emne/Subject:	Dato/Date:
Mål/Scale: 1:1		Revideret/Revision: 2016-10-07-VXX	Signatur / Signature XX

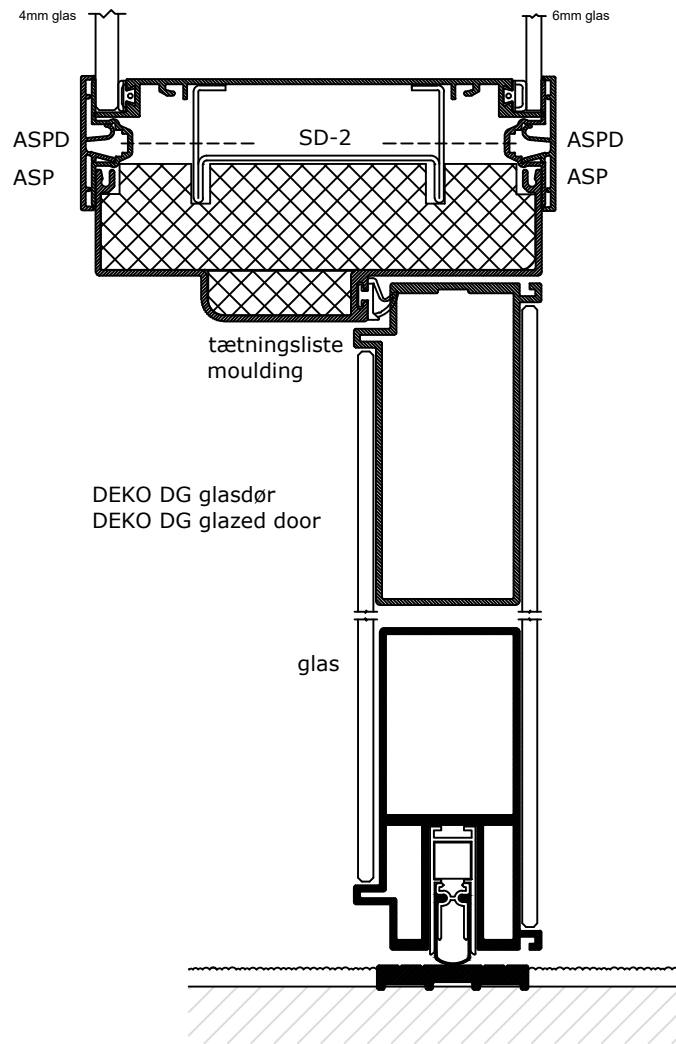

	DEKO Tlf./Tel: +45 43 55 77 11 www.deko.dk / www.deko.com	Projekt/Project: DEKO GV 1290	
	Sags Nr./Case No.:	Emne/Subject: L4H	Dato/Date:
Mål/Scale: 1:1		Revideret/Revision: 2016-10-07-VXX	Signatur Signature XX