

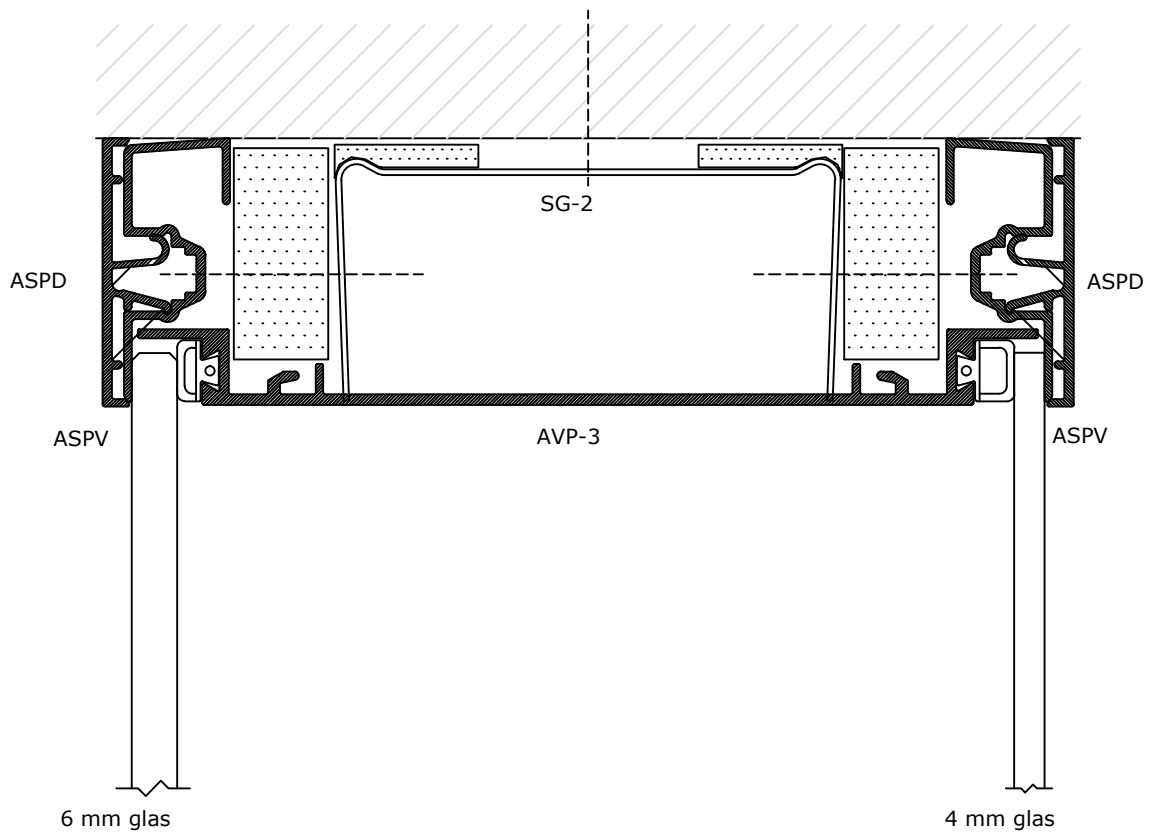

	DEKO Tlf./Tel: +45 43 55 77 11 www.deko.dk / www.deko.com	Projekt/Project: DEKO GV 1290	
	Sags Nr./Case No.:	Emne/Subject: L1E	Dato/Date:
Mål/Scale: 1:1		Revideret/Revision: 2016-10-07-VXX	Signatur Signature XX



	DEKO Tlf./Tel: +45 43 55 77 11 www.deko.dk / www.deko.com	Projekt/Project: DEKO GV 1290	
	Sags Nr./Case No.:	Emne/Subject: L1F	Dato/Date:
Mål/Scale: 1:1		Revideret/Revision: 2016-10-07-VXX	Signatur Signature XX

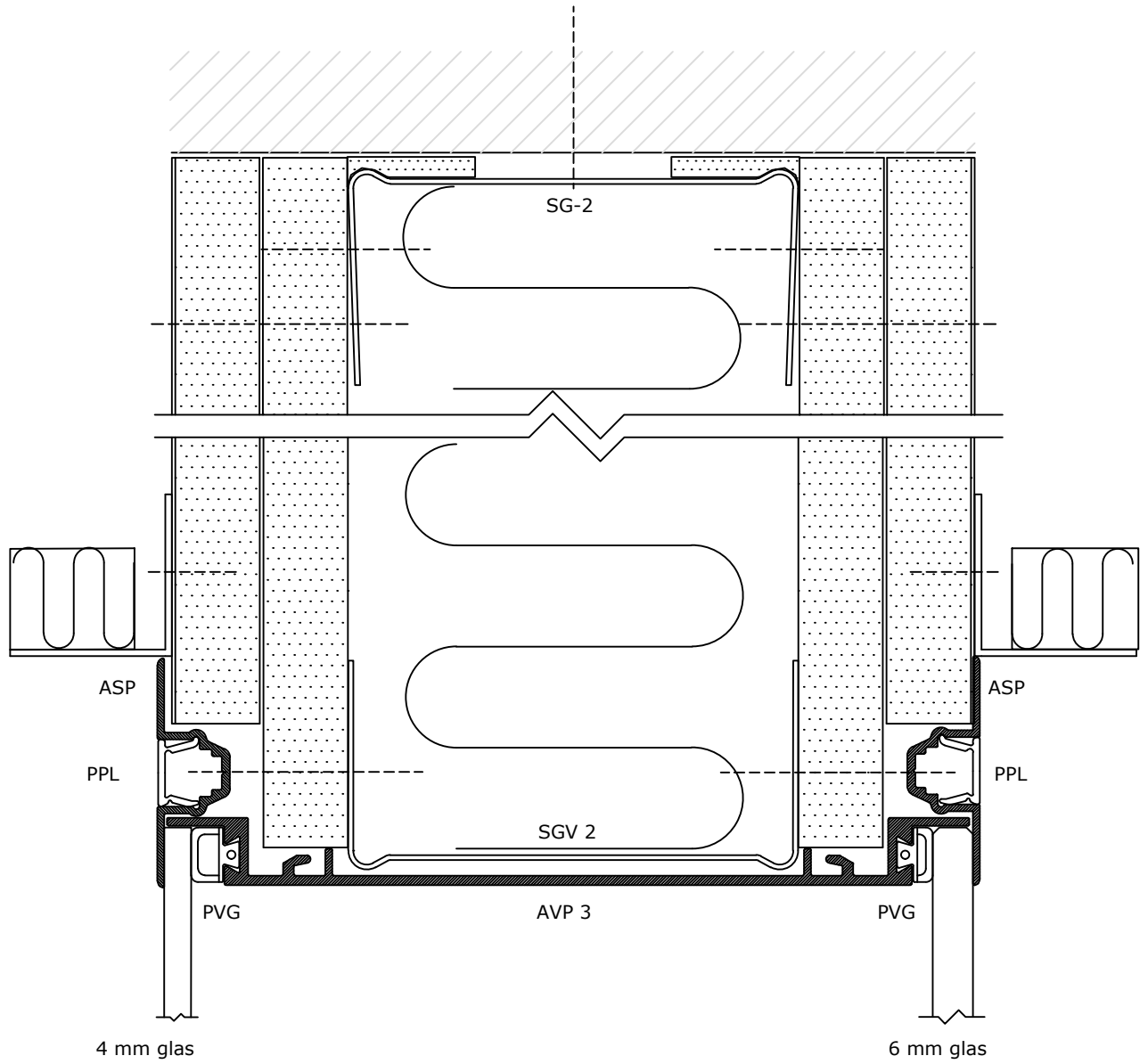

	DEKO Tlf./Tel: +45 43 55 77 11 www.deko.dk / www.deko.com	Projekt/Project: DEKO GV 1290	
	Sags Nr./Case No.:	Emne/Subject: L1G	Dato/Date:
Mål/Scale: 1:1		Revideret/Revision: 2016-10-07-VXX	Signatur Signature XX

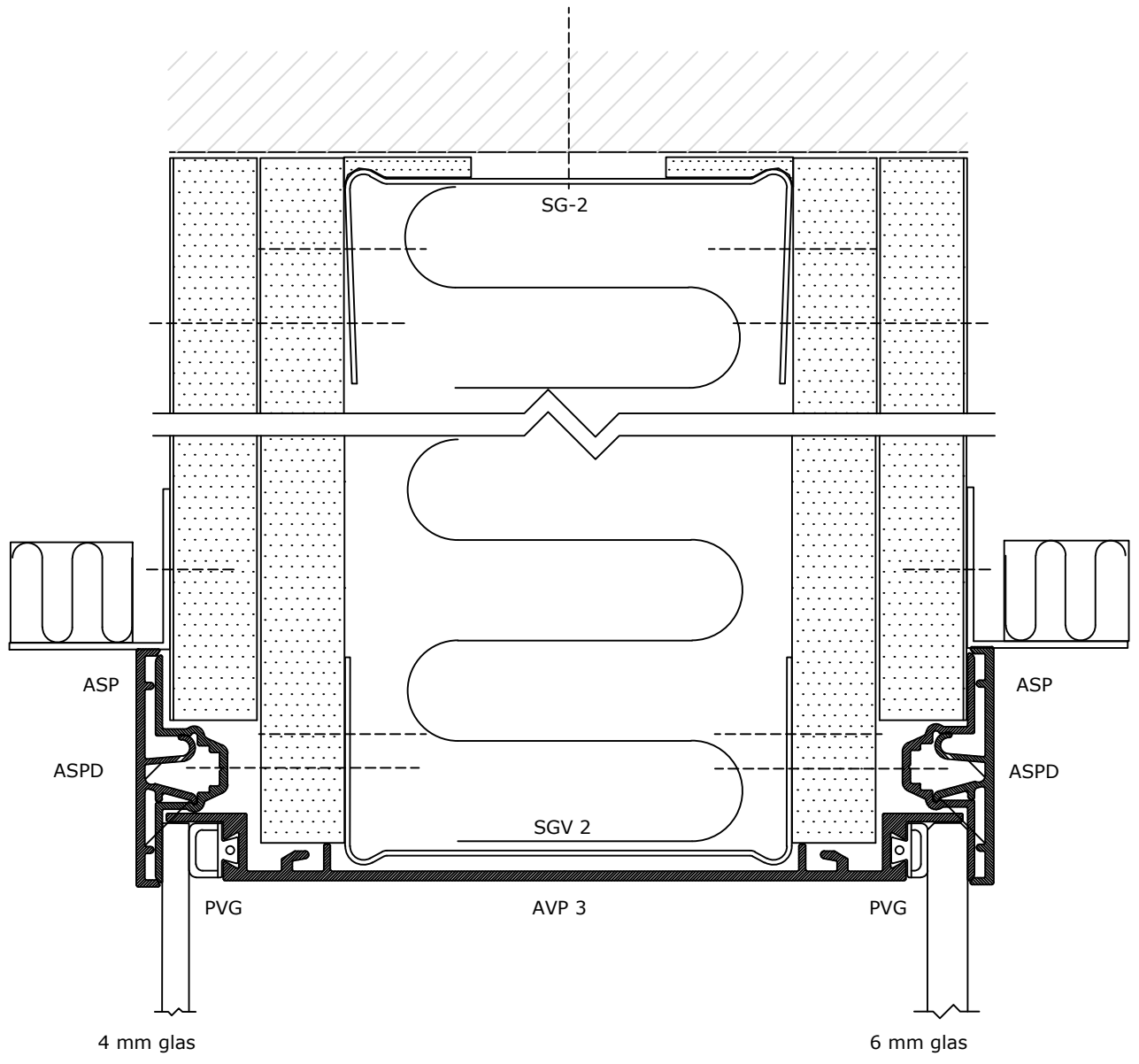

	DEKO Tlf./Tel: +45 43 55 77 11 www.deko.dk / www.deko.com	Projekt/Project: DEKO GV 1290	
	Sags Nr./Case No.:	Emne/Subject: L1H	Dato/Date:
Mål/Scale: 1:1		Revideret/Revision: 2016-10-07-VXX	Signatur Signature XX

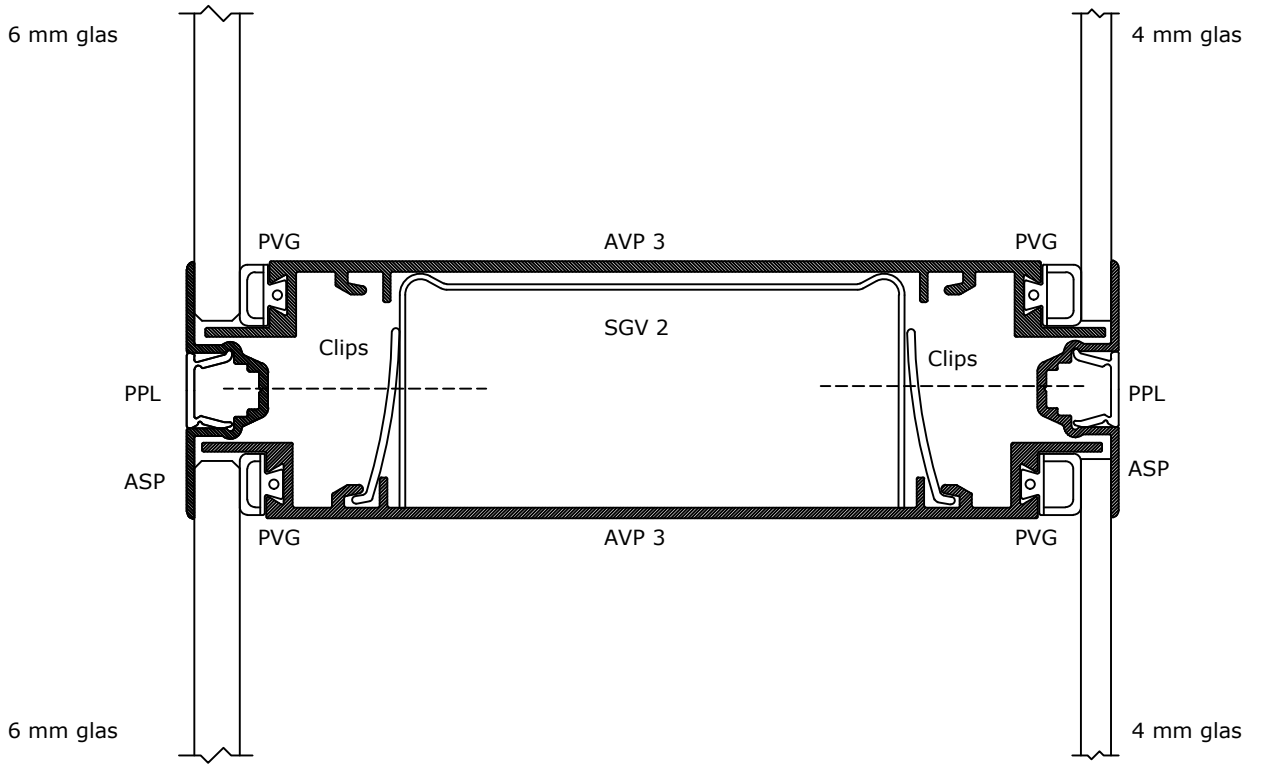

	DEKO Tlf./Tel: +45 43 55 77 11 www.deko.dk / www.deko.com	Projekt/Project: DEKO GV 1290	
	Sags Nr./Case No.:	Emne/Subject: L2B	Dato/Date:
Mål/Scale: 1:1		Revideret/Revision: 2016-10-07-VXX	Signatur Signature XX

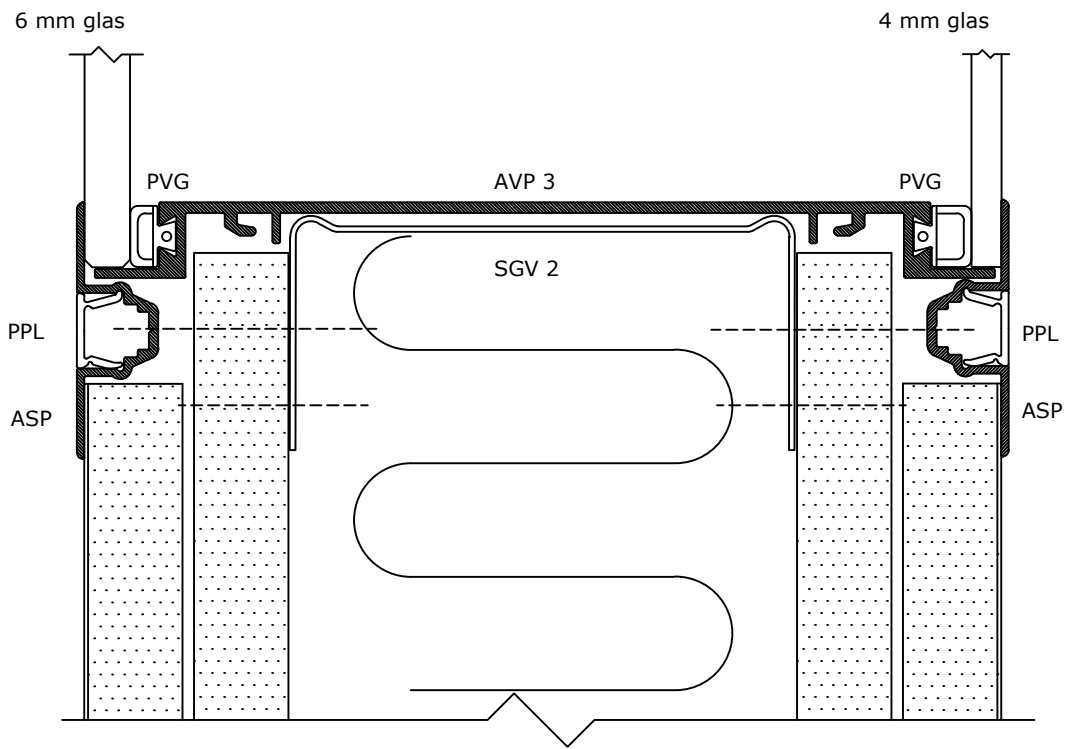

	DEKO Tlf./Tel: +45 43 55 77 11 www.deko.dk / www.deko.com	Projekt/Project: DEKO GV 1290	
	Sags Nr./Case No.: L2C	Emne/Subject:	Dato/Date:
Mål/Scale: 1:1		Revideret/Revision: 2016-10-07-VXX	Signatur Signature XX

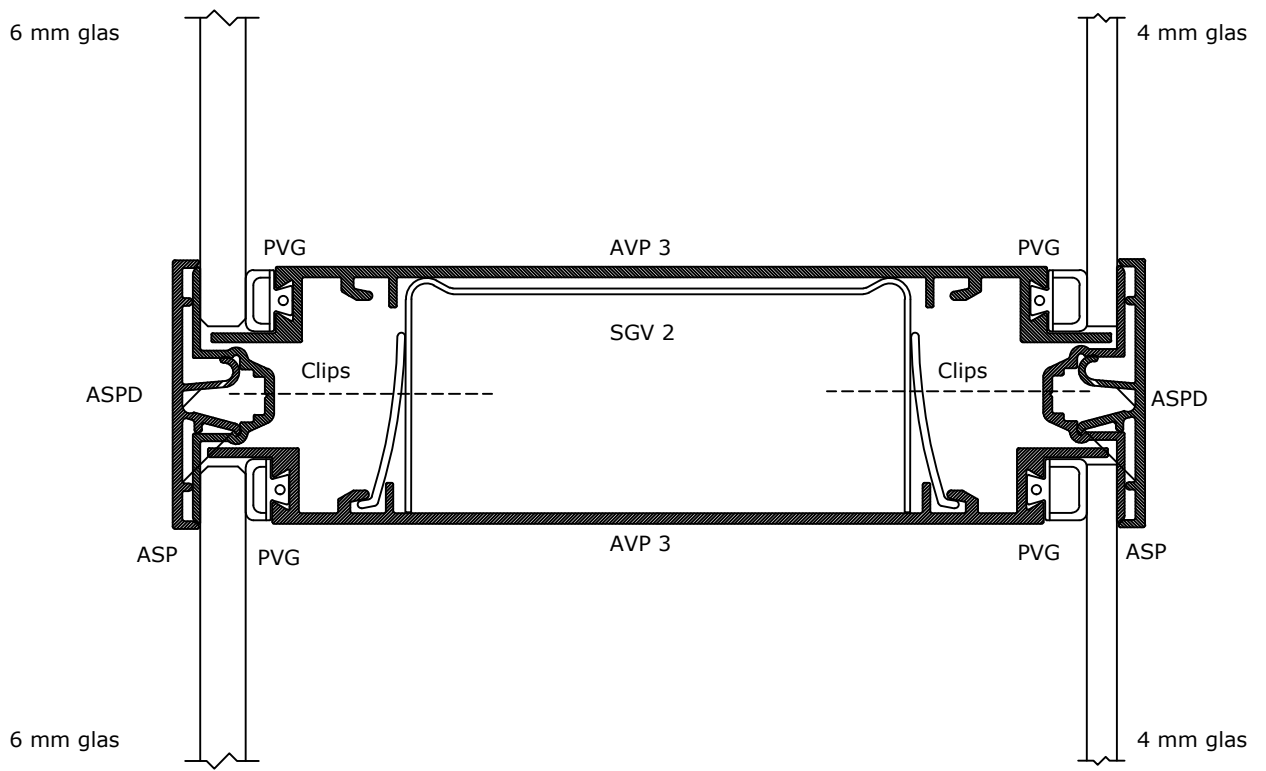

	DEKO Tlf./Tel: +45 43 55 77 11 www.deko.dk / www.deko.com	Projekt/Project: DEKO GV 1290	
	Sags Nr./Case No.: 	Emne/Subject: L2D	Dato/Date:
Mål/Scale: 1:1	 	Revideret/Revision: 2016-10-07-VXX	Signatur Signature XX

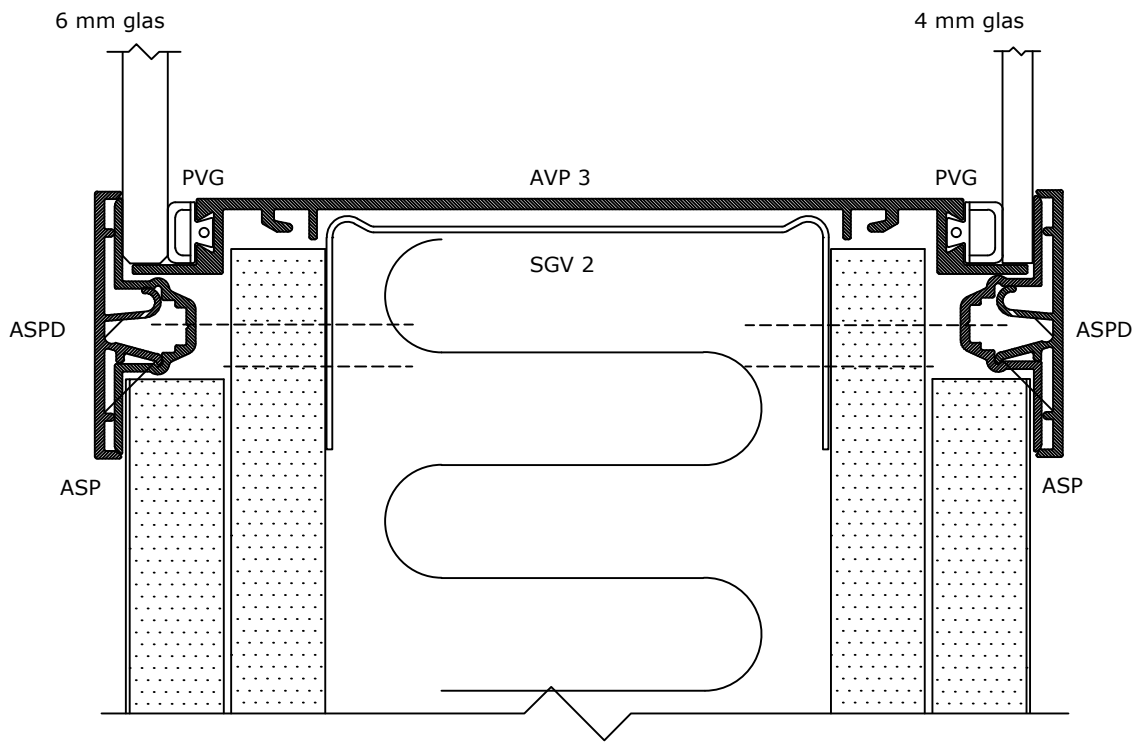

	DEKO Tlf./Tel: +45 43 55 77 11 www.deko.dk / www.deko.com	Projekt/Project: DEKO GV 1290	
	Sags Nr./Case No.:	Emne/Subject: L2E	Dato/Date:
Mål/Scale: 1:1		Revideret/Revision: 2016-10-07-VXX	Signatur Signature XX

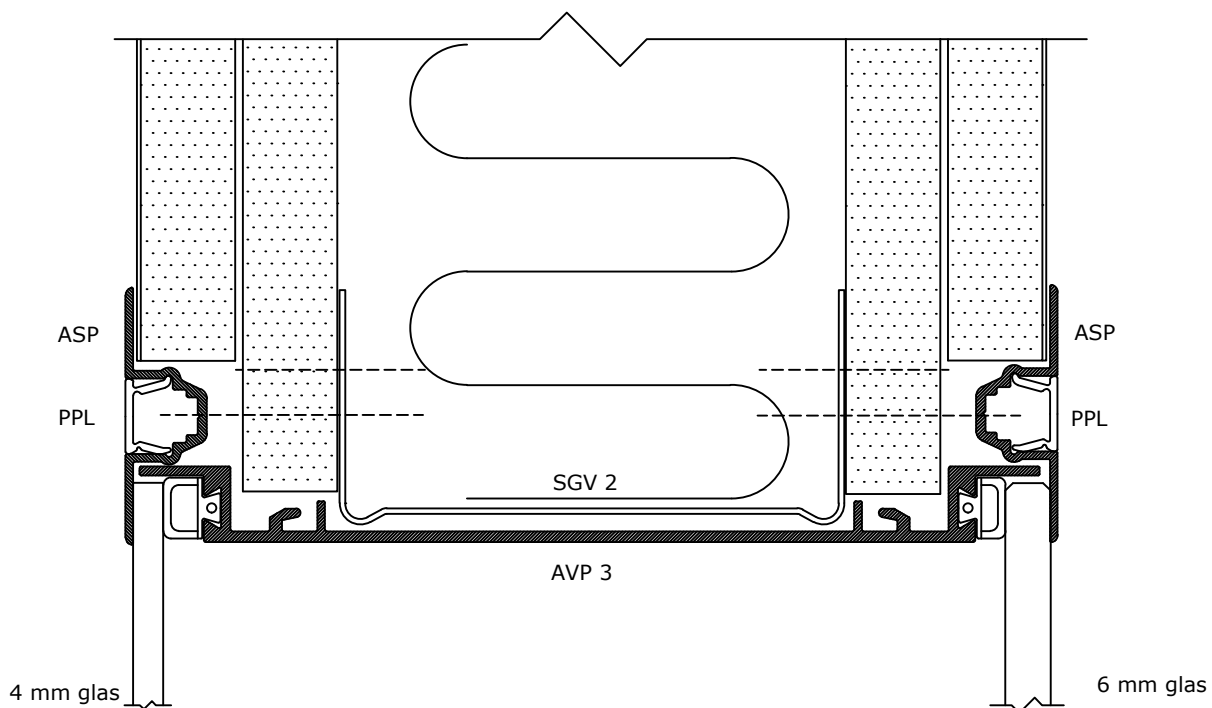

	DEKO Tlf./Tel: +45 43 55 77 11 www.deko.dk / www.deko.com	Projekt/Project: DEKO GV 1290	
	Sags Nr./Case No.:	Emne/Subject: L2F	Dato/Date:
Mål/Scale: 1:1		Revideret/Revision: 2016-10-07-VXX	Signatur Signature XX

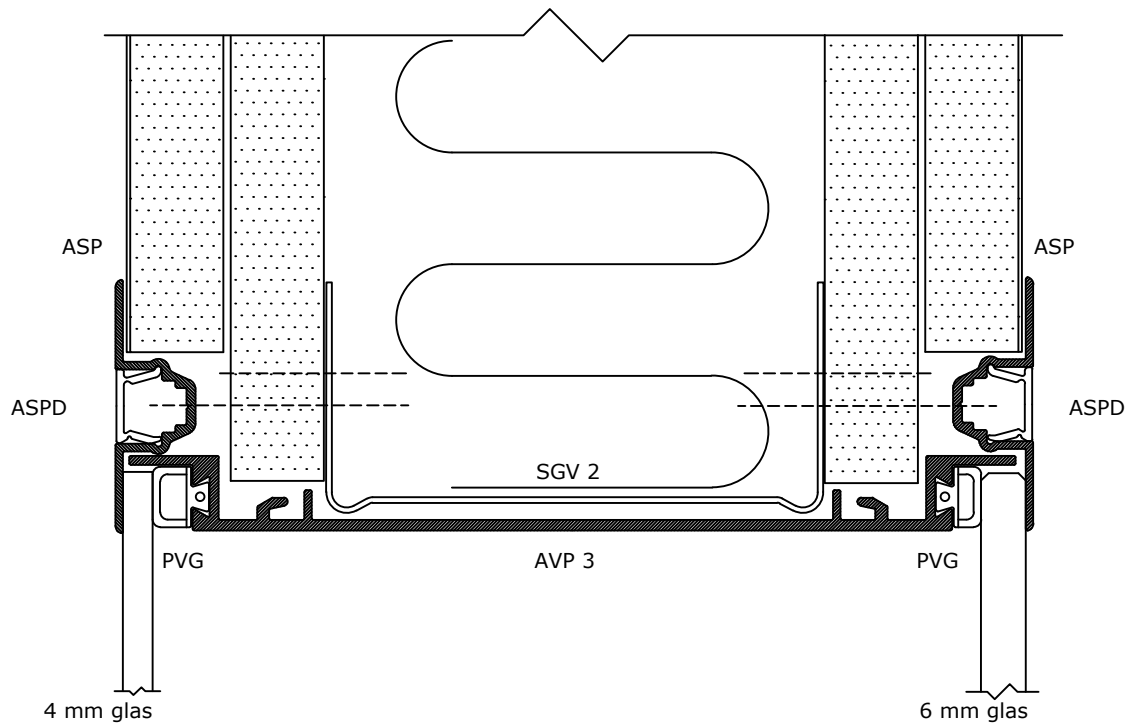

	DEKO Tlf./Tel: +45 43 55 77 11 www.deko.dk / www.deko.com	Projekt/Project: DEKO GV 1290	
	Sags Nr./Case No.:	Emne/Subject: L2G	Dato/Date:
Mål/Scale: 1:1		Revideret/Revision: 2016-10-07-VXX	Signatur Signature XX

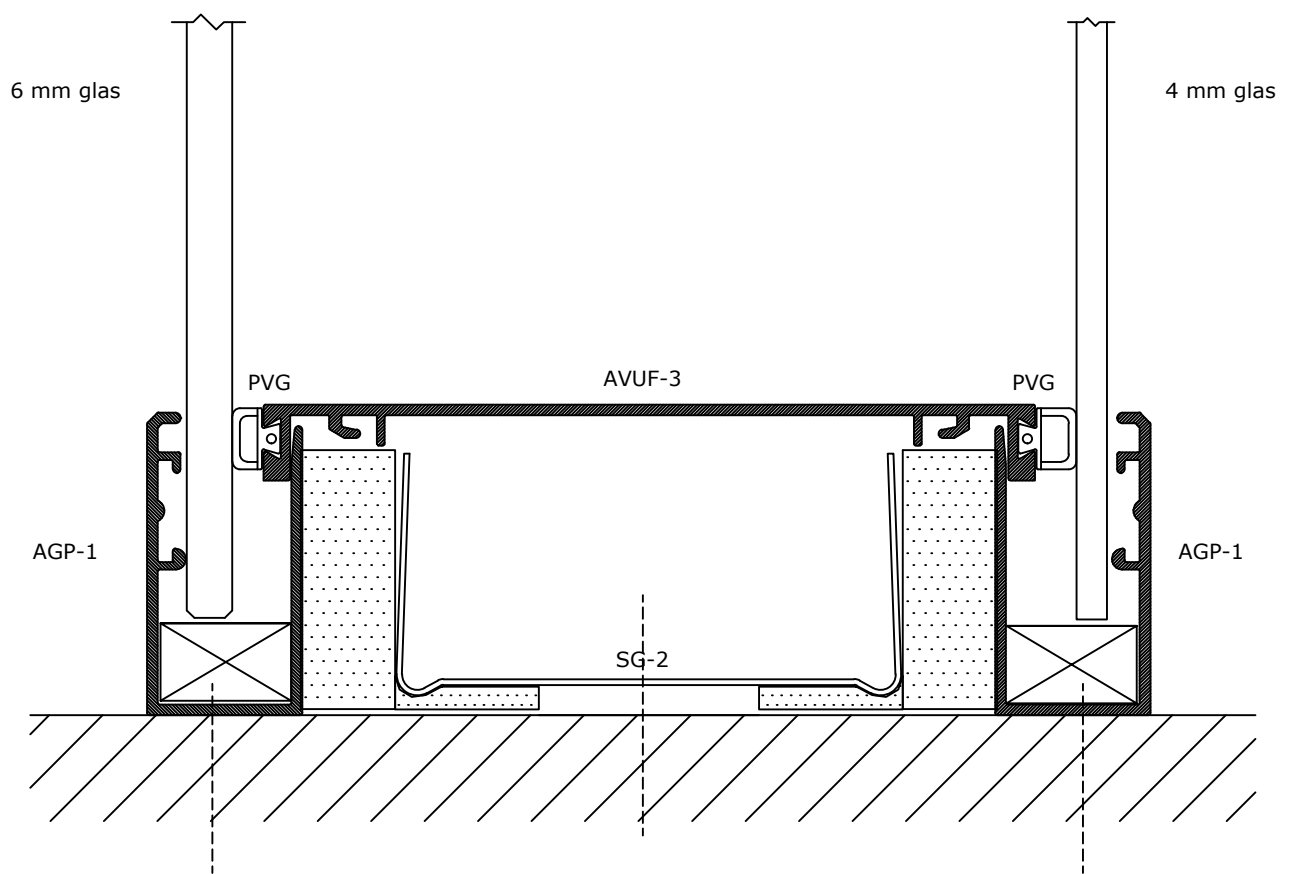

	DEKO Tlf./Tel: +45 43 55 77 11 www.deko.dk / www.deko.com	Projekt/Project: DEKO GV 1290	
	Sags Nr./Case No.: L3D	Emne/Subject:	Dato/Date:
Mål/Scale: 1:1		Revideret/Revision: 2016-10-07-VXX	Signatur Signature XX

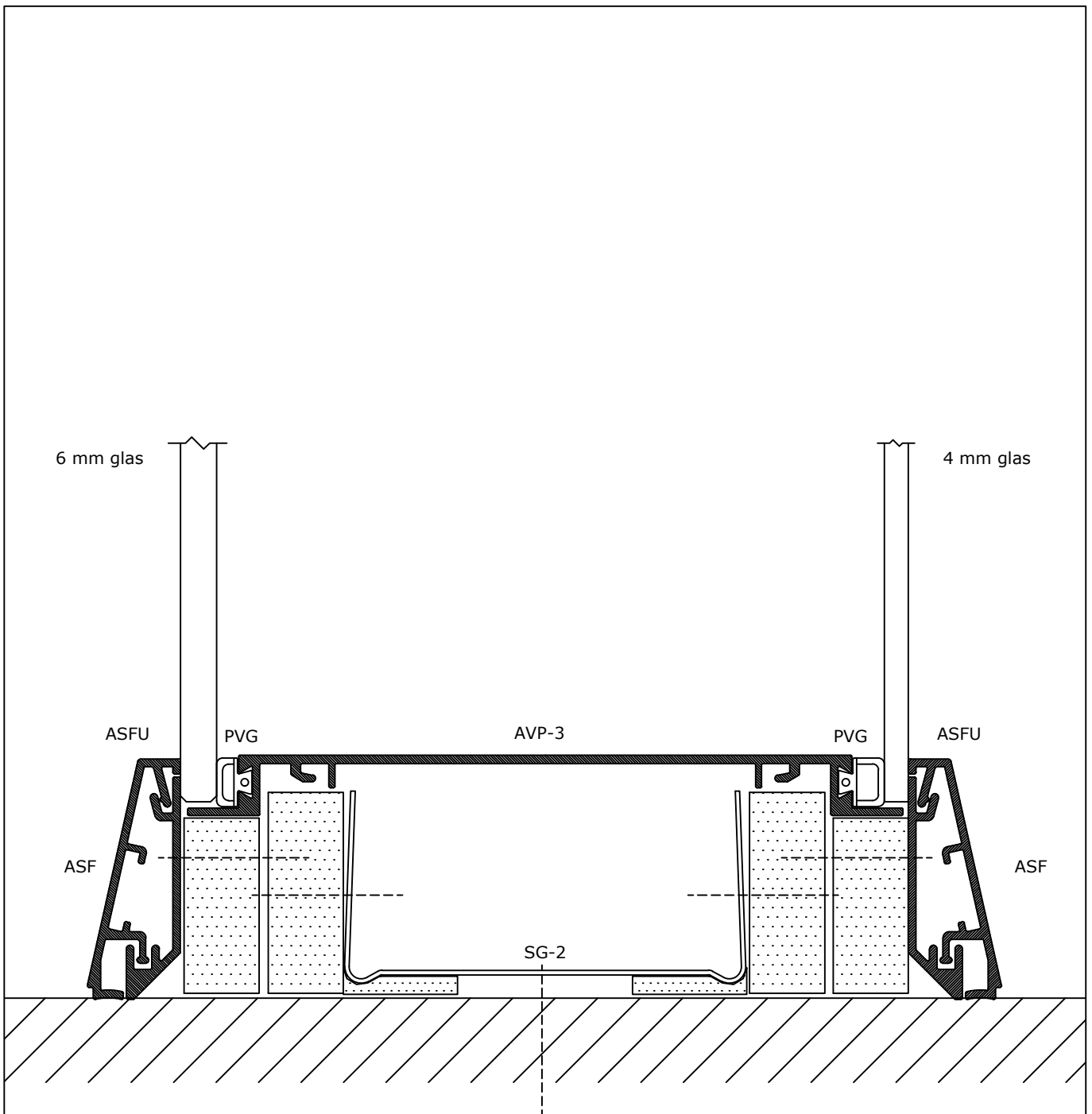

	DEKO Tlf./Tel: +45 43 55 77 11 www.deko.dk / www.deko.com	Projekt/Project: DEKO GV 1290	
	Sags Nr./Case No.: L3F	Emne/Subject:	Dato/Date:
Mål/Scale: 1:1		Revideret/Revision: 2016-10-07-VXX	Signatur Signature XX

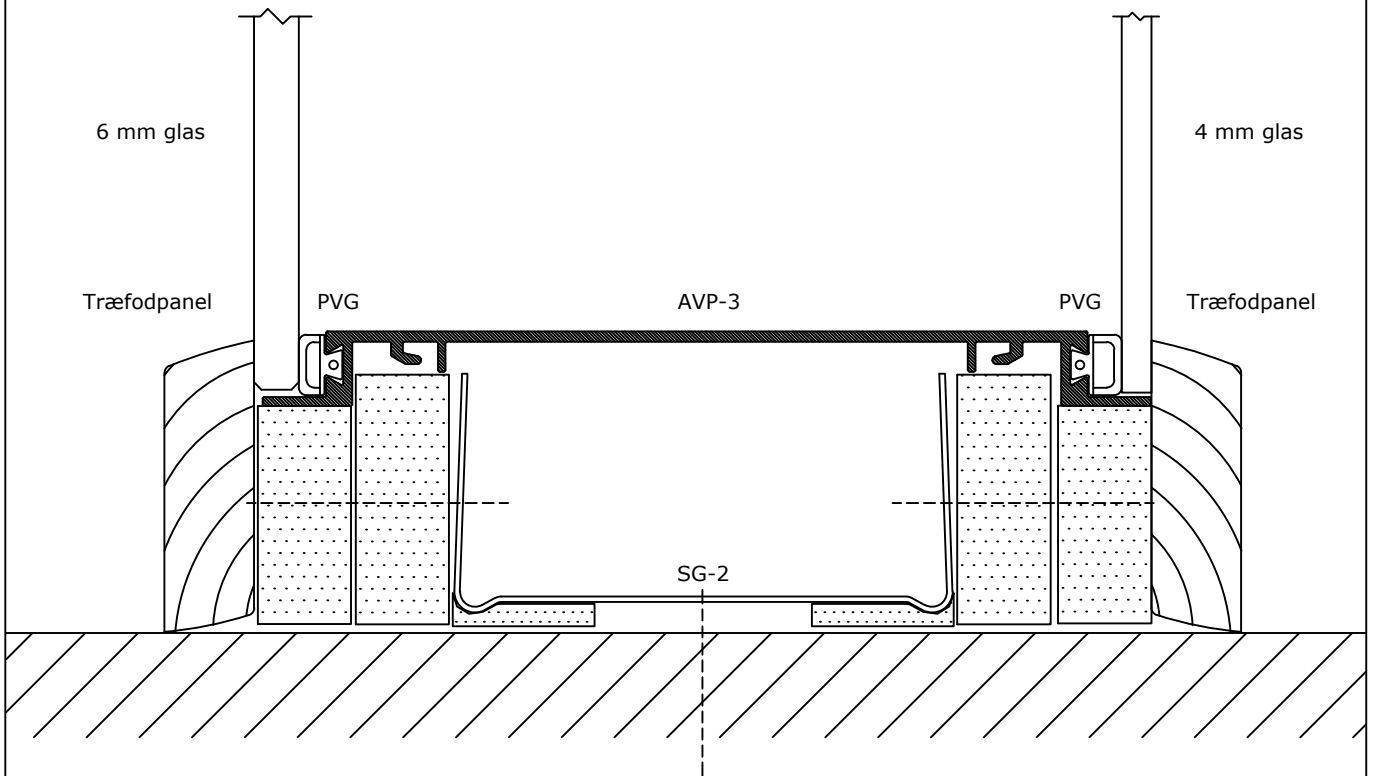

	DEKO Tlf./Tel: +45 43 55 77 11 www.deko.dk / www.deko.com	Projekt/Project: DEKO GV 1290	
	Sags Nr./Case No.: 	Emne/Subject: L3J	Dato/Date:
Mål/Scale: 1:1	 	Revideret/Revision: 2016-10-07-VXX	Signatur Signature XX

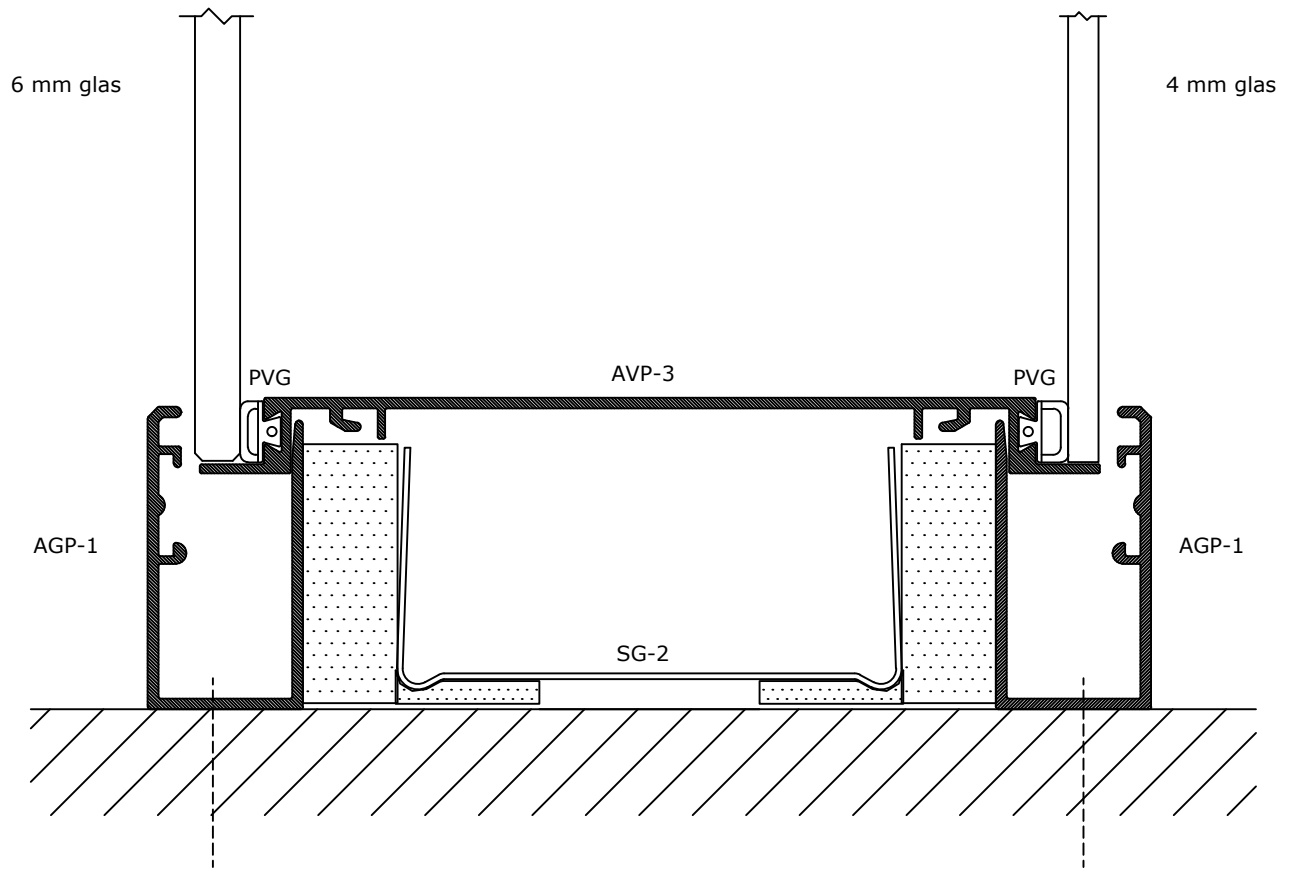

	DEKO Tlf./Tel: +45 43 55 77 11 www.deko.dk / www.deko.com	Projekt/Project: DEKO GV 1290	
	Sags Nr./Case No.: L3M	Emne/Subject:	Dato/Date:
Mål/Scale: 1:1		Revideret/Revision: 2016-10-07-VXX	Signatur Signature XX

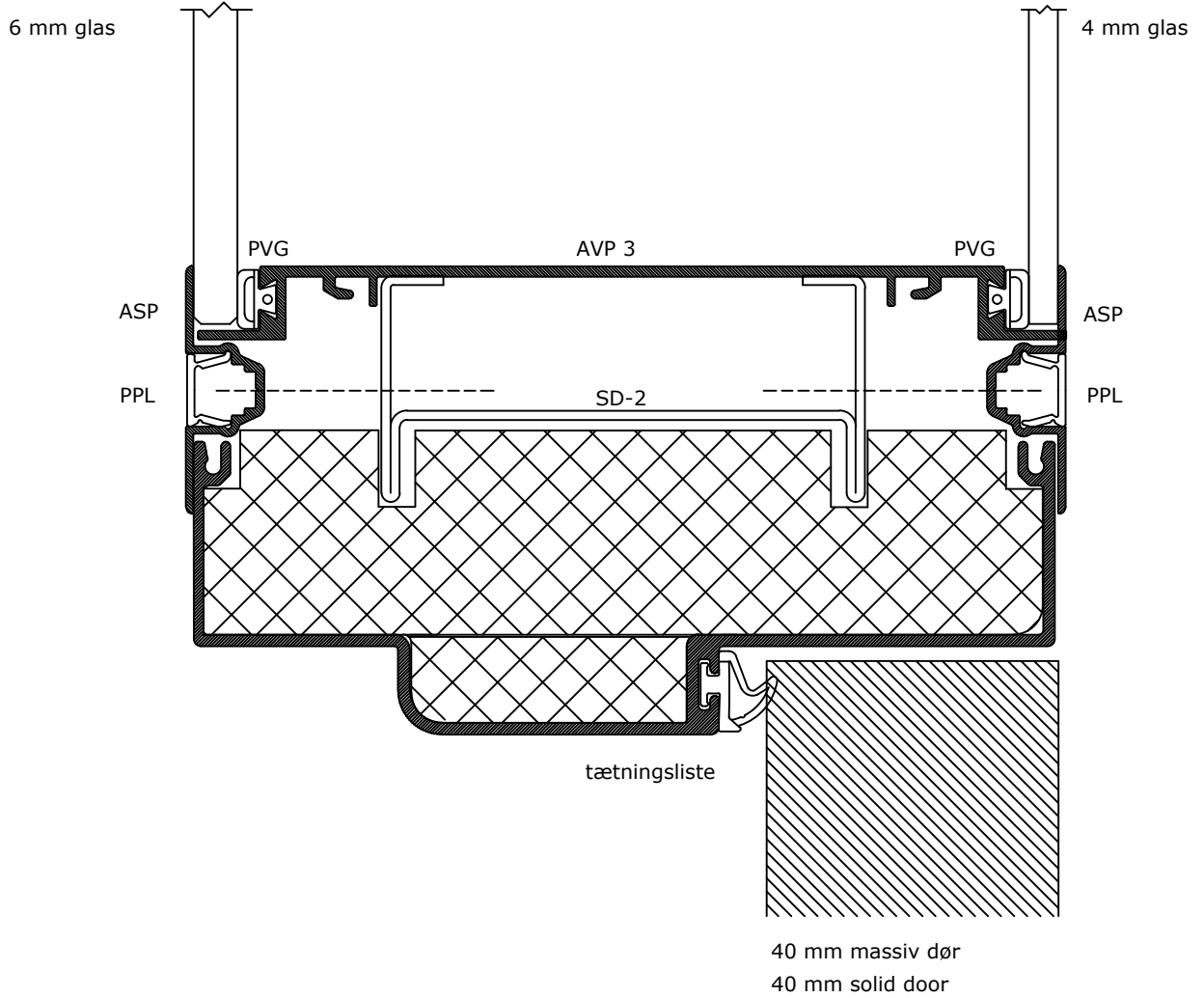

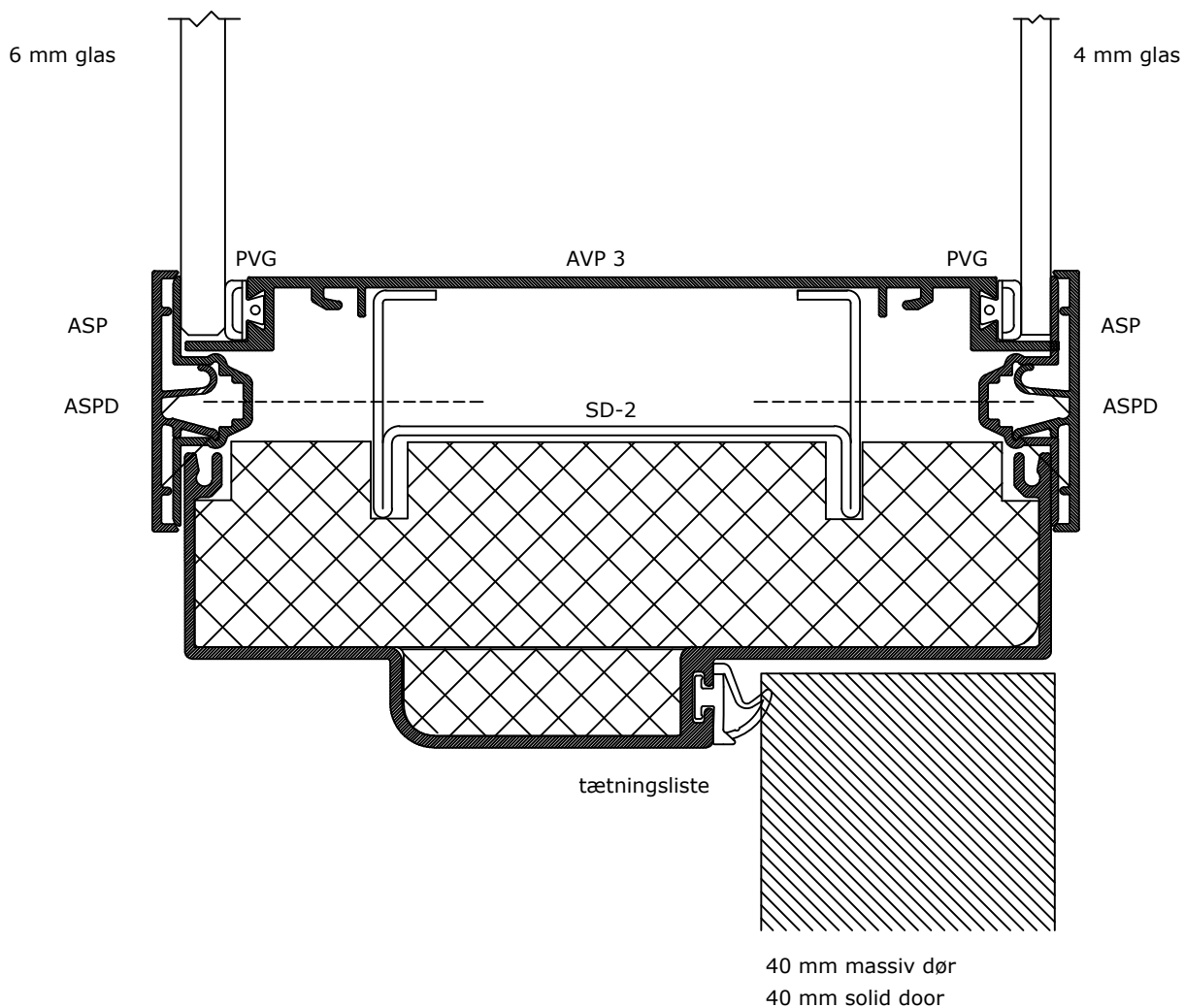

	DEKO Tlf./Tel: +45 43 55 77 11 www.deko.dk / www.deko.com	Projekt/Project: DEKO GV 1290	
	Sags Nr./Case No.: L4C	Emne/Subject:	Dato/Date:
Mål/Scale: 1:1		Revideret/Revision: 2016-10-07-VXX	Signatur Signature XX



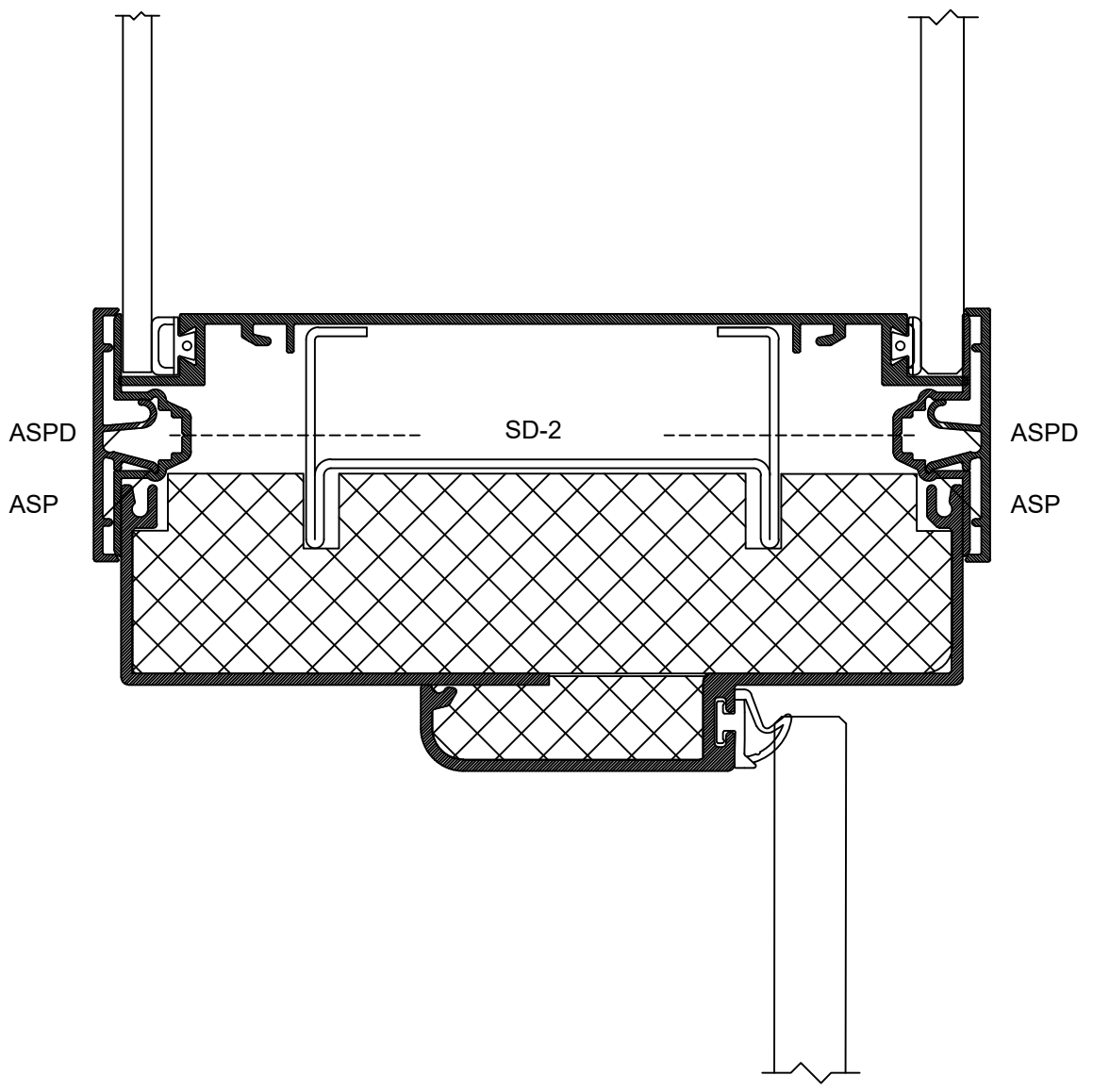

	DEKO Tlf./Tel: +45 43 55 77 11 www.deko.dk / www.deko.com	Projekt/Project: DEKO GV 1290	
	Sags Nr./Case No.: L4D	Emne/Subject: L4D	Dato/Date: 2016-10-07-VXX
Mål/Scale: 1:1		Revideret/Revision: 2016-10-07-VXX	Signatur Signature XX

1290 L4F

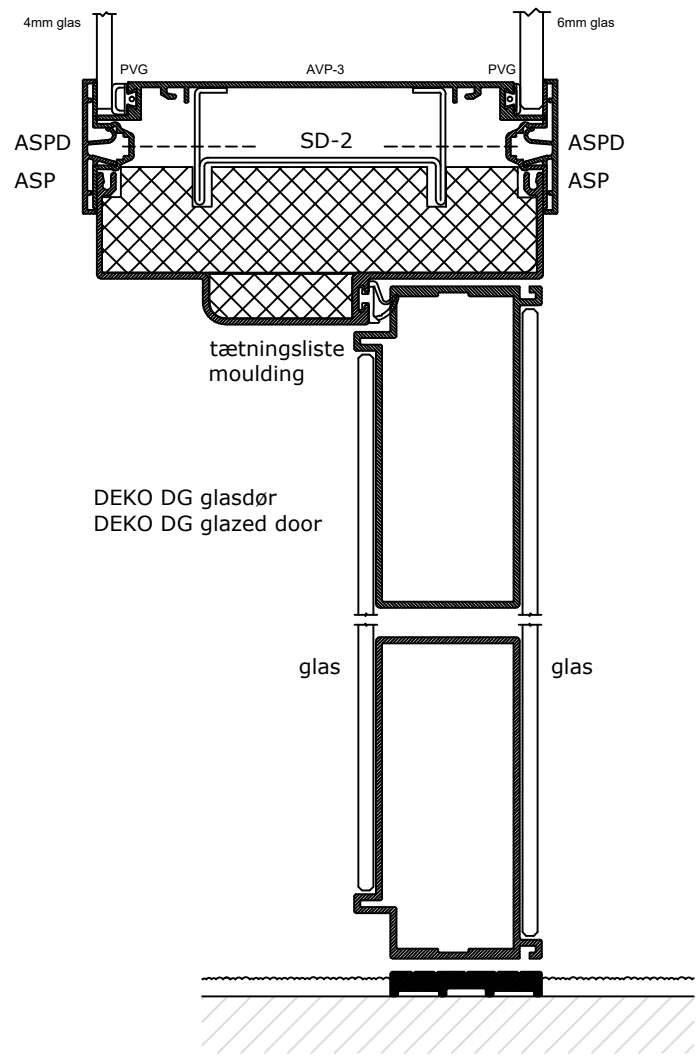

	DEKO Tlf./Tel: +45 43 55 77 11 www.deko.dk / www.deko.com	Projekt/Project: DEKO GV 1290	
	Sags Nr./Case No.:	Emne/Subject: L4F	Dato/Date:
Mål/Scale: 1:1		Revideret/Revision: 2016-10-07-VXX	Signatur Signature XX



	DEKO Tlf./Tel: +45 43 55 77 11 www.deko.dk / www.deko.com	Projekt/Project: DEKO GV 1290	
	Sags Nr./Case No.: 	Emne/Subject: L4G	Dato/Date:
Mål/Scale: 1:1	 	Revideret/Revision: 2016-10-07-VXX	Signatur / Signature XX

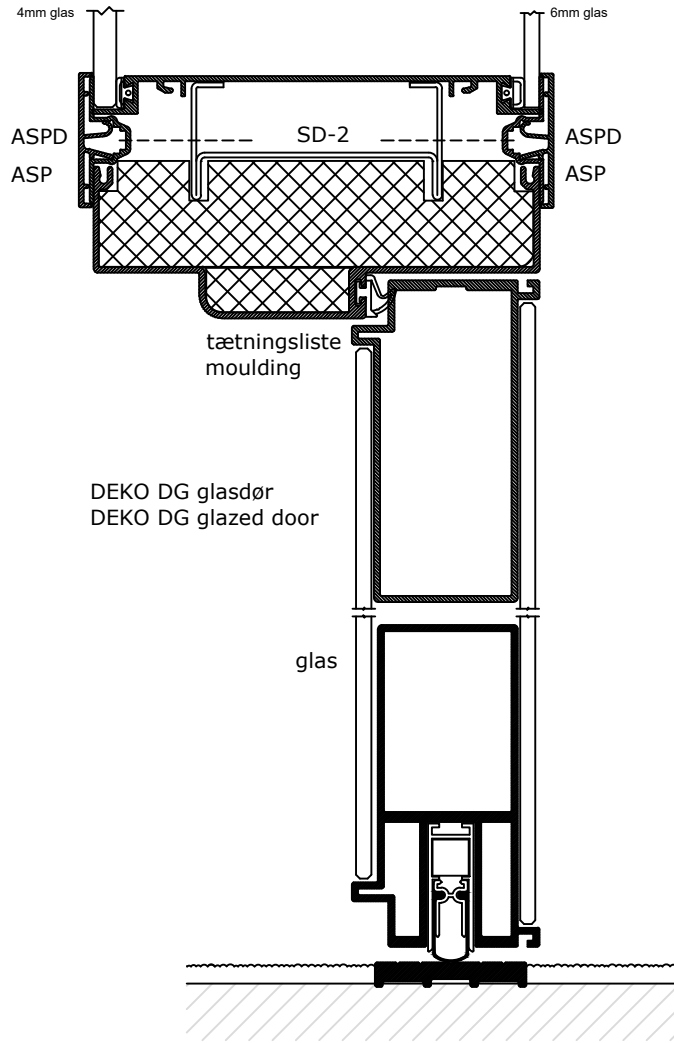

	DEKO Tlf./Tel: +45 43 55 77 11 www.deko.dk / www.deko.com	Projekt/Project: DEKO GV 1290	
	Sags Nr./Case No.:	Emne/Subject: L4H	Dato/Date:
Mål/Scale: 1:1		Revideret/Revision: 2016-10-07-VXX	Signatur Signature XX

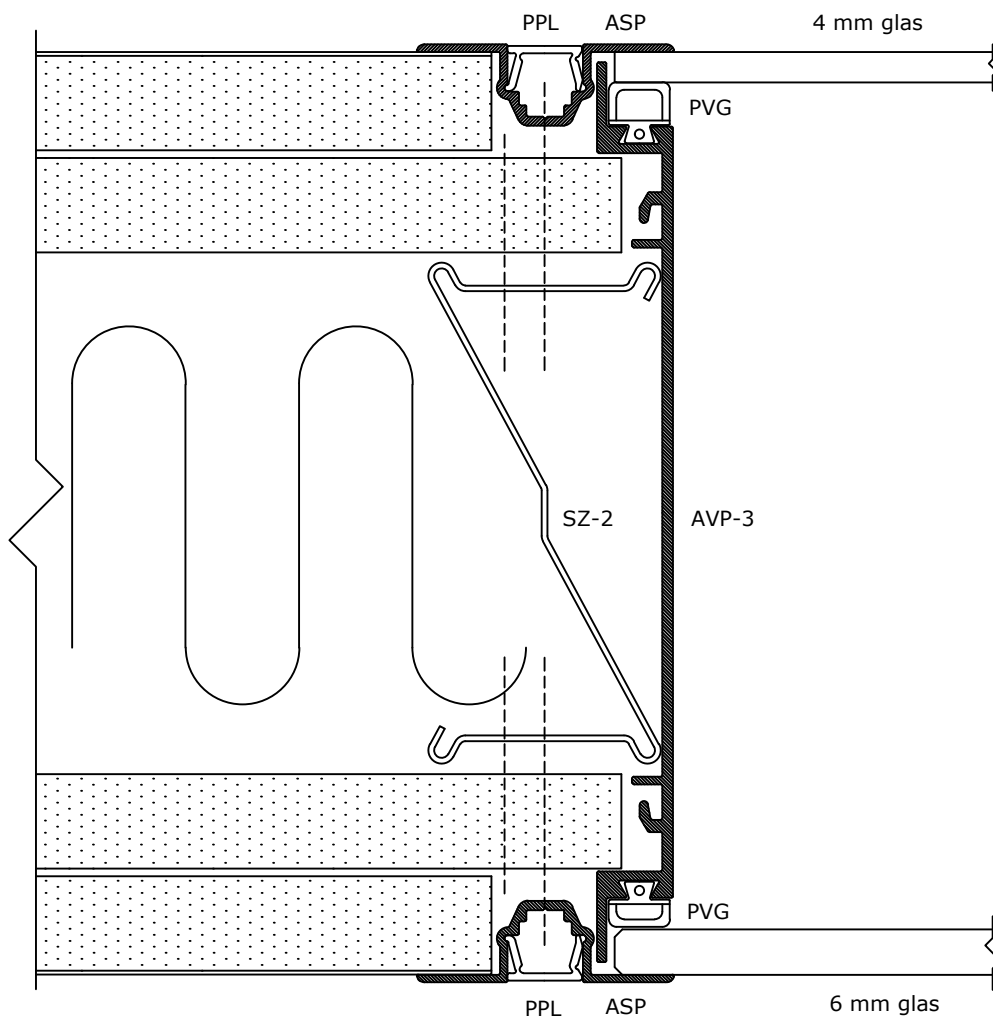

	DEKO Tlf./Tel: +45 43 55 77 11 www.deko.dk / www.deko.com	Projekt/Project: DEKO GV 1290	
	Sags Nr./Case No.: V1B	Emne/Subject: V1B	Dato/Date:
Mål/Scale: 1:1		Revideret/Revision: 2016-10-07-VXX	Signatur Signature XX

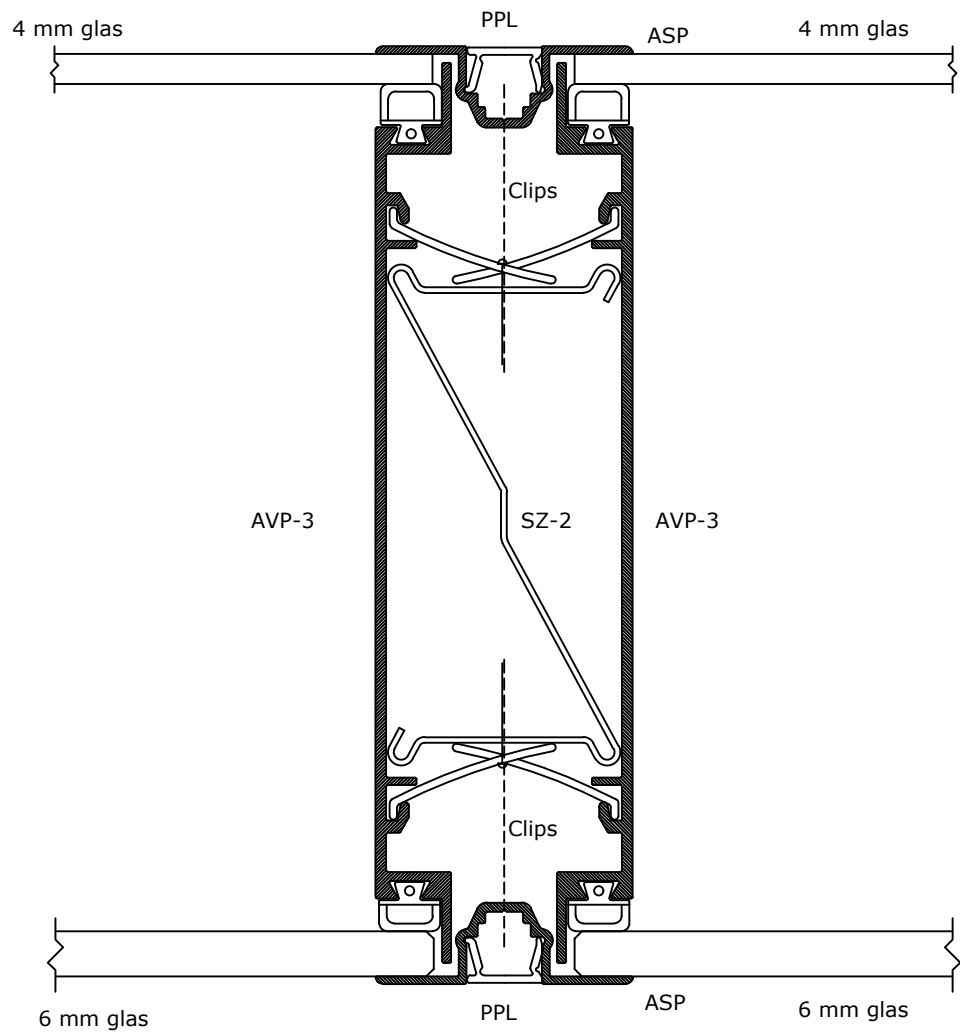

	DEKO Tlf./Tel: +45 43 55 77 11 www.deko.dk / www.deko.com	Projekt/Project: DEKO GV 1290	
	Sags Nr./Case No.:	Emne/Subject: V1C	Dato/Date:
Mål/Scale: 1:1		Revideret/Revision: 2016-10-07-VXX	Signatur Signature XX

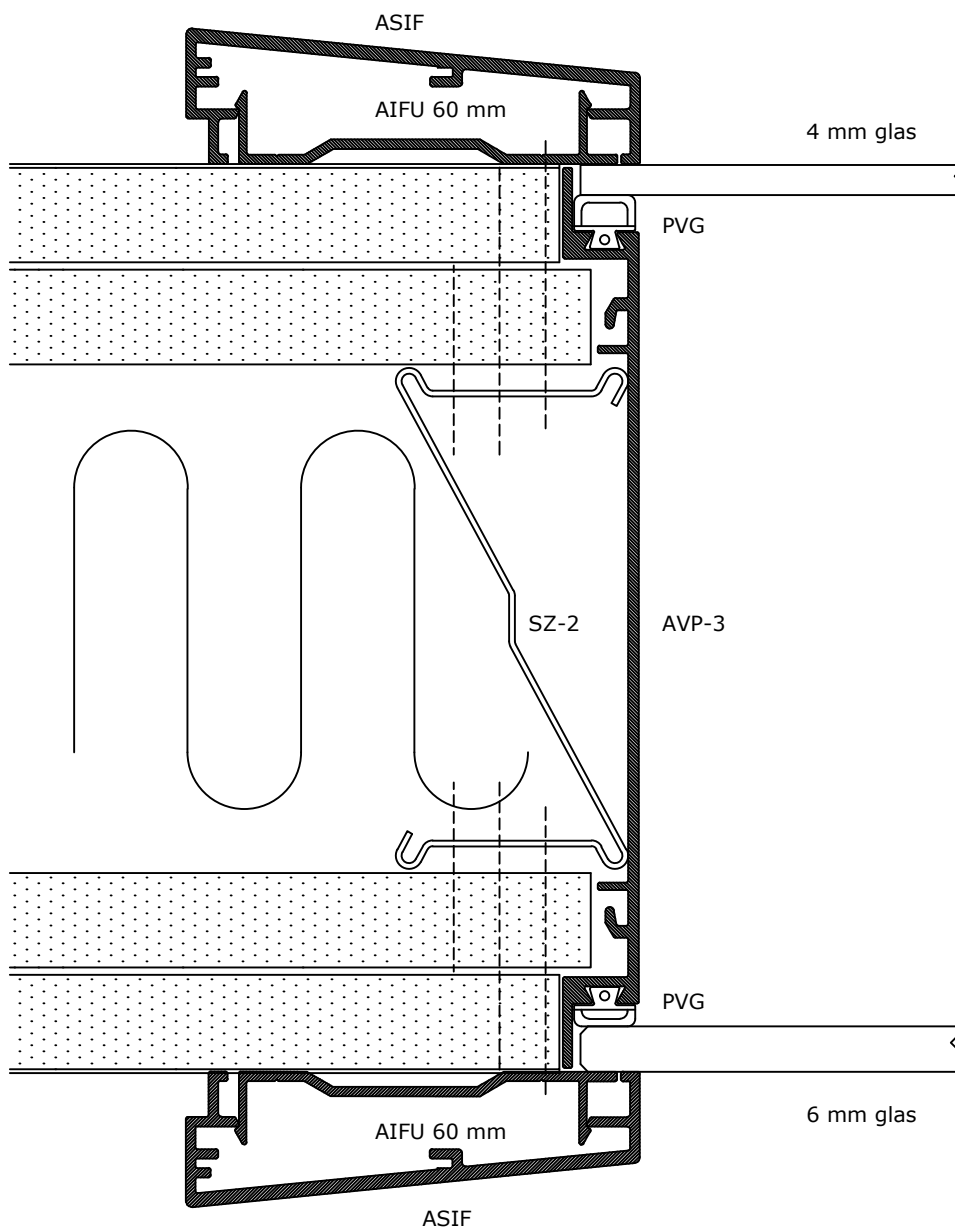

	DEKO Tlf./Tel: +45 43 55 77 11 www.deko.dk / www.deko.com	Projekt/Project: DEKO GV 1290	
	Sags Nr./Case No.: V1D	Emne/Subject:	Dato/Date:
Mål/Scale: 1:1		Revideret/Revision: 2016-10-07-VXX	Signatur Signature XX

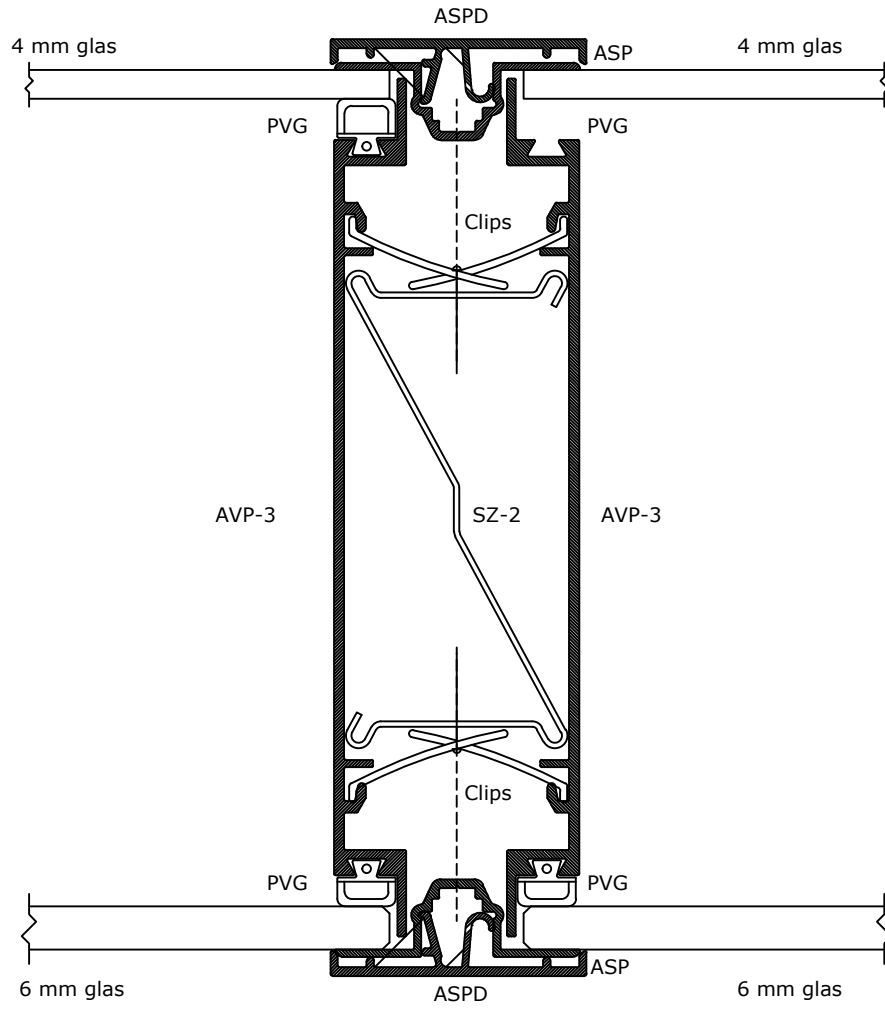

	DEKO Tlf./Tel: +45 43 55 77 11 www.deko.dk / www.deko.com	Projekt/Project: DEKO GV 1290	
	Sags Nr./Case No.: V1E	Emne/Subject:	Dato/Date:
Mål/Scale: 1:1		Revideret/Revision: 2016-10-07-VXX	Signatur Signature XX

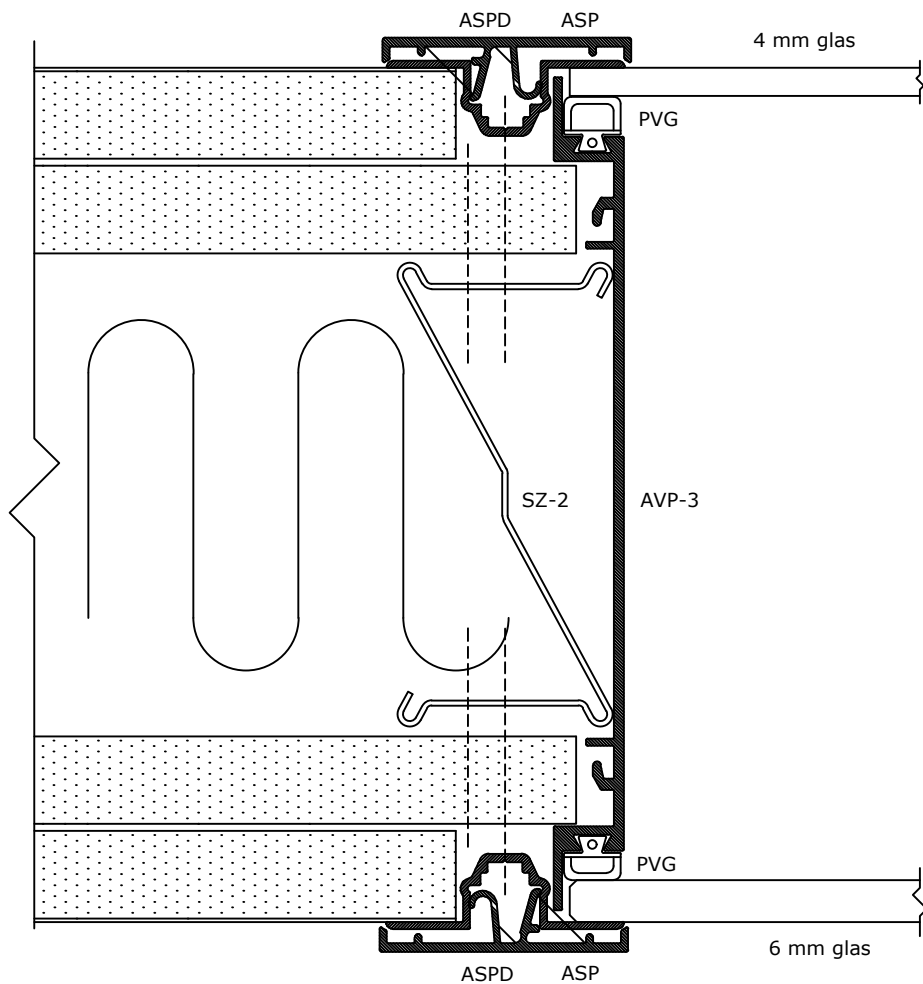

	DEKO Tlf./Tel: +45 43 55 77 11 www.deko.dk / www.deko.com	Projekt/Project: DEKO GV 1290	
	Sags Nr./Case No.:	Emne/Subject: V1F	Dato/Date:
Mål/Scale: 1:1		Revideret/Revision: 2016-10-07-VXX	Signatur Signature XX

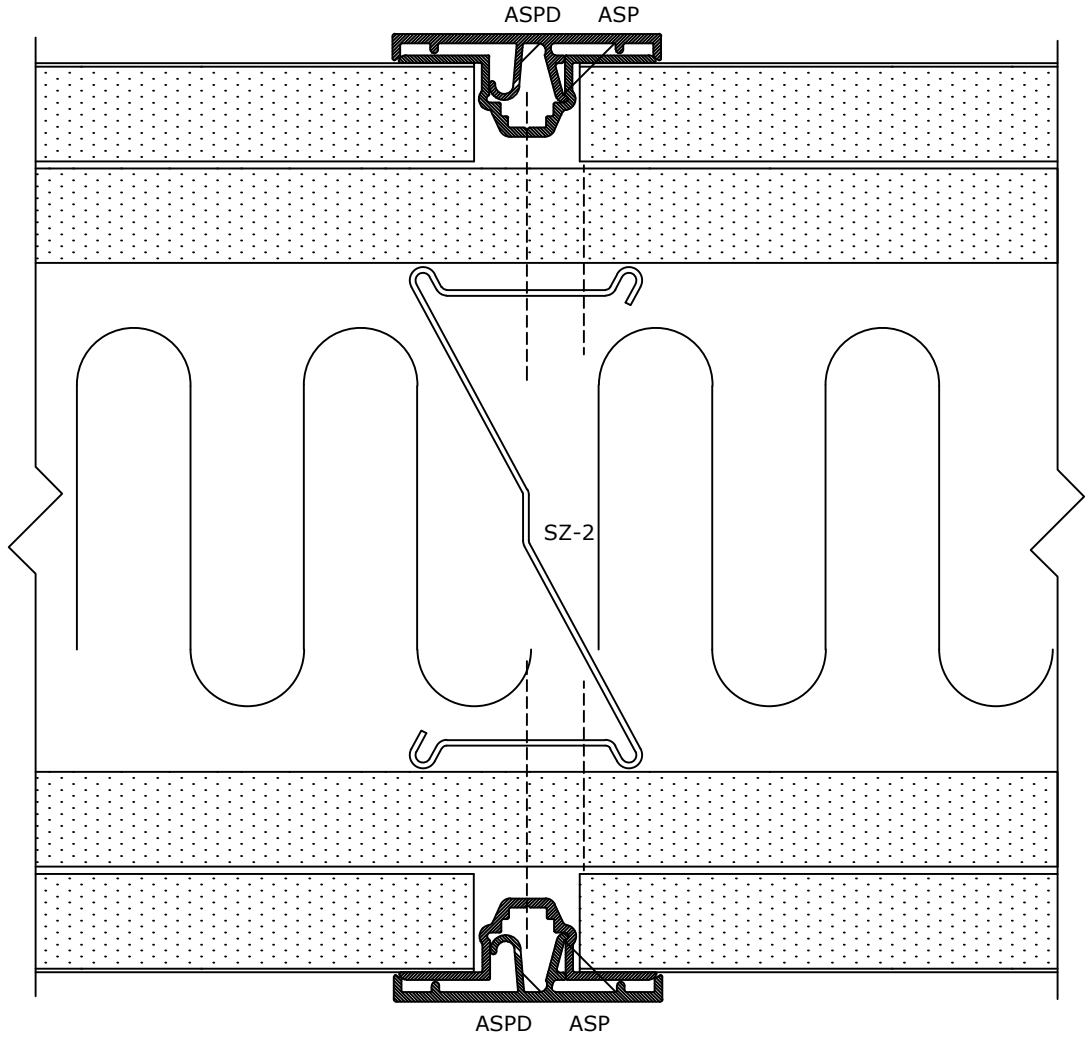

	DEKO Tlf./Tel: +45 43 55 77 11 www.deko.dk / www.deko.com	Projekt/Project: DEKO GV 1290	
	Sags Nr./Case No.:	Emne/Subject: V1I	Dato/Date:
Mål/Scale: 1:1		Revideret/Revision: 2016-10-07-VXX	Signatur Signature XX

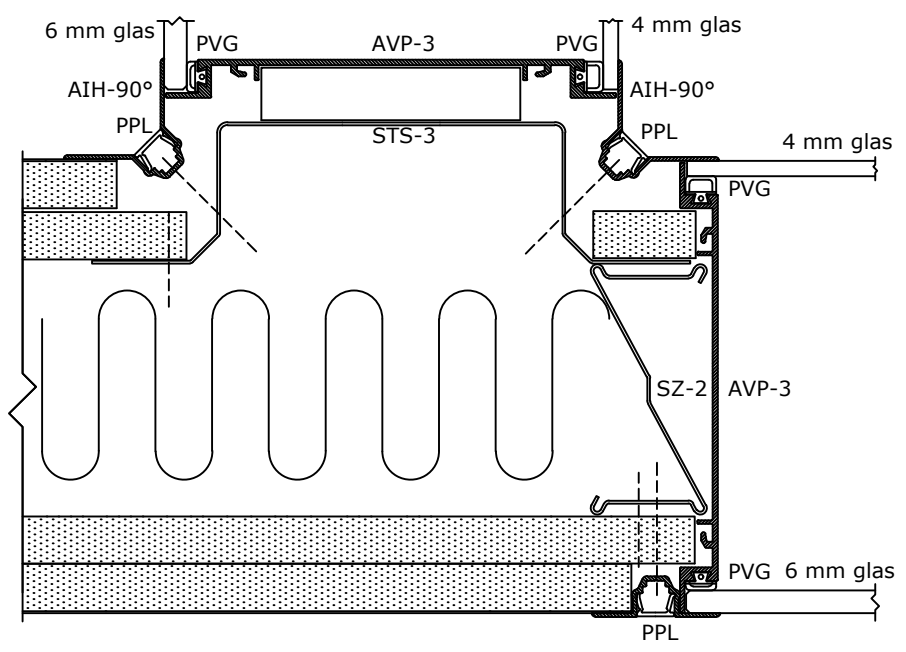

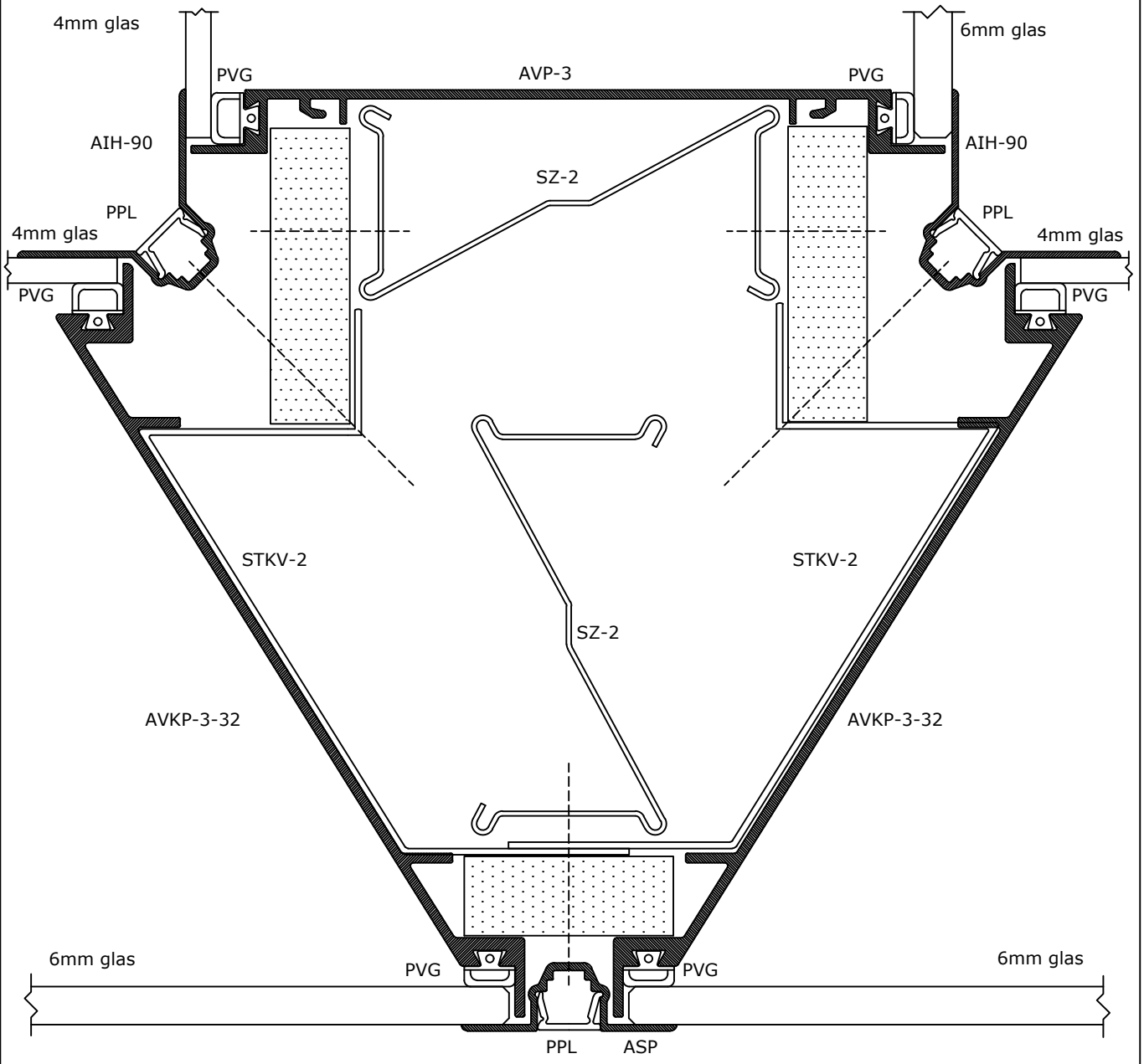

	DEKO Tlf./Tel: +45 43 55 77 11 www.deko.dk / www.deko.com	Projekt/Project: DEKO GV 1290	
	Sags Nr./Case No.: V2B	Emne/Subject:	Dato/Date:
Mål/Scale: 1:2		Revideret/Revision: 2016-10-07-VXX	Signatur Signature XX



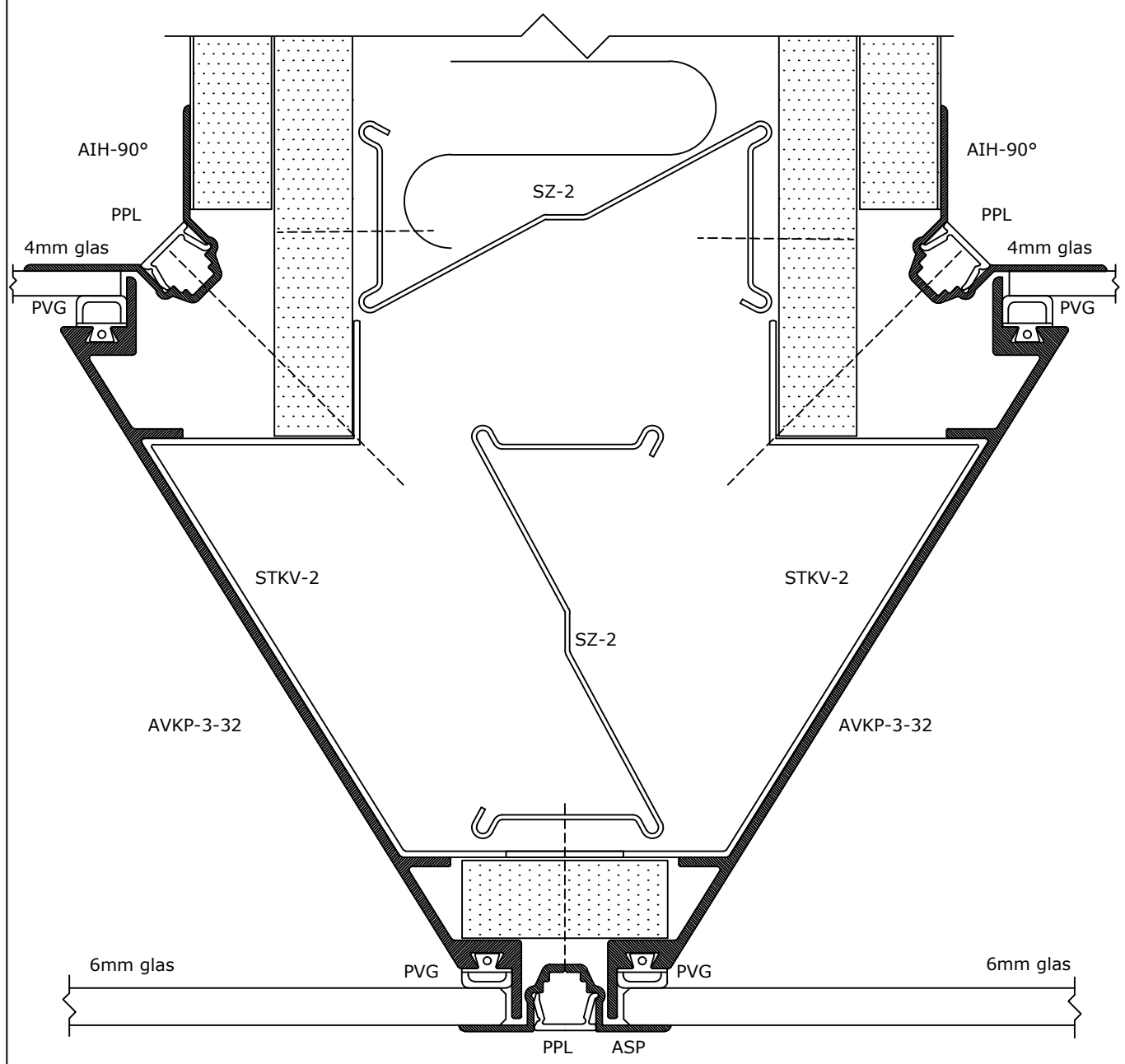

	DEKO Tlf./Tel: +45 43 55 77 11 www.deko.dk / www.deko.com	Projekt/Project: DEKO GV 1290	
	Sags Nr./Case No.:	Emne/Subject: V2C	Dato/Date:
Mål/Scale: 1:1		Revideret/Revision: 2016-10-07-VXX	Signatur Signature XX

1290 V2D

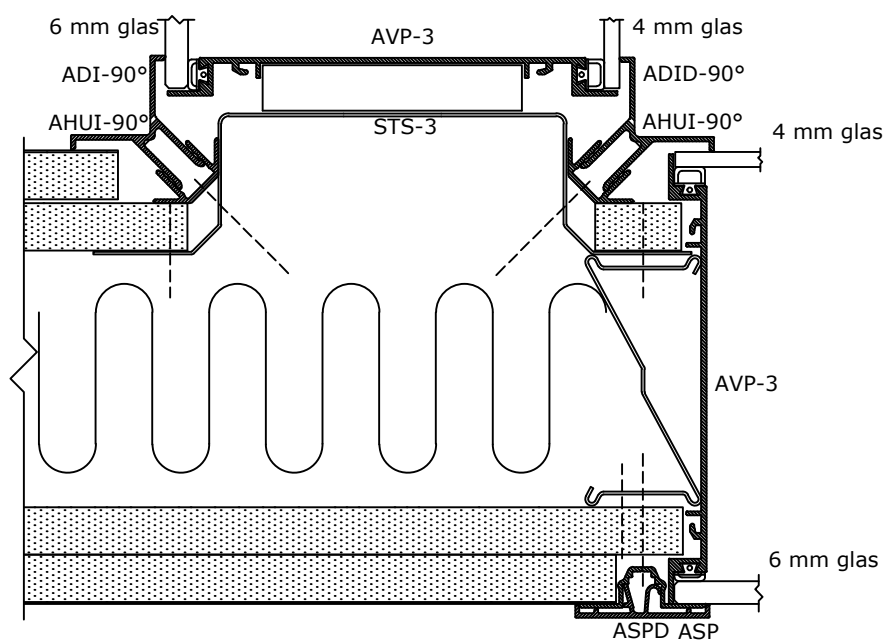

	DEKO Tlf./Tel: +45 43 55 77 11 www.deko.dk / www.deko.com	Projekt/Project: DEKO GV 1290	
	Sags Nr./Case No.:	Emne/Subject: V2D	Dato/Date:
Mål/Scale: 1:1		Revideret/Revision: 2016-10-07-VXX	Signatur Signature XX



	DEKO Tlf./Tel: +45 43 55 77 11 www.deko.dk / www.deko.com	Projekt/Project: DEKO GV 1290	
	Sags Nr./Case No.:	Emne/Subject: V2H	Dato/Date:
Mål/Scale: 1:2		Revideret/Revision: 2016-10-07-VXX	Signatur Signature XX

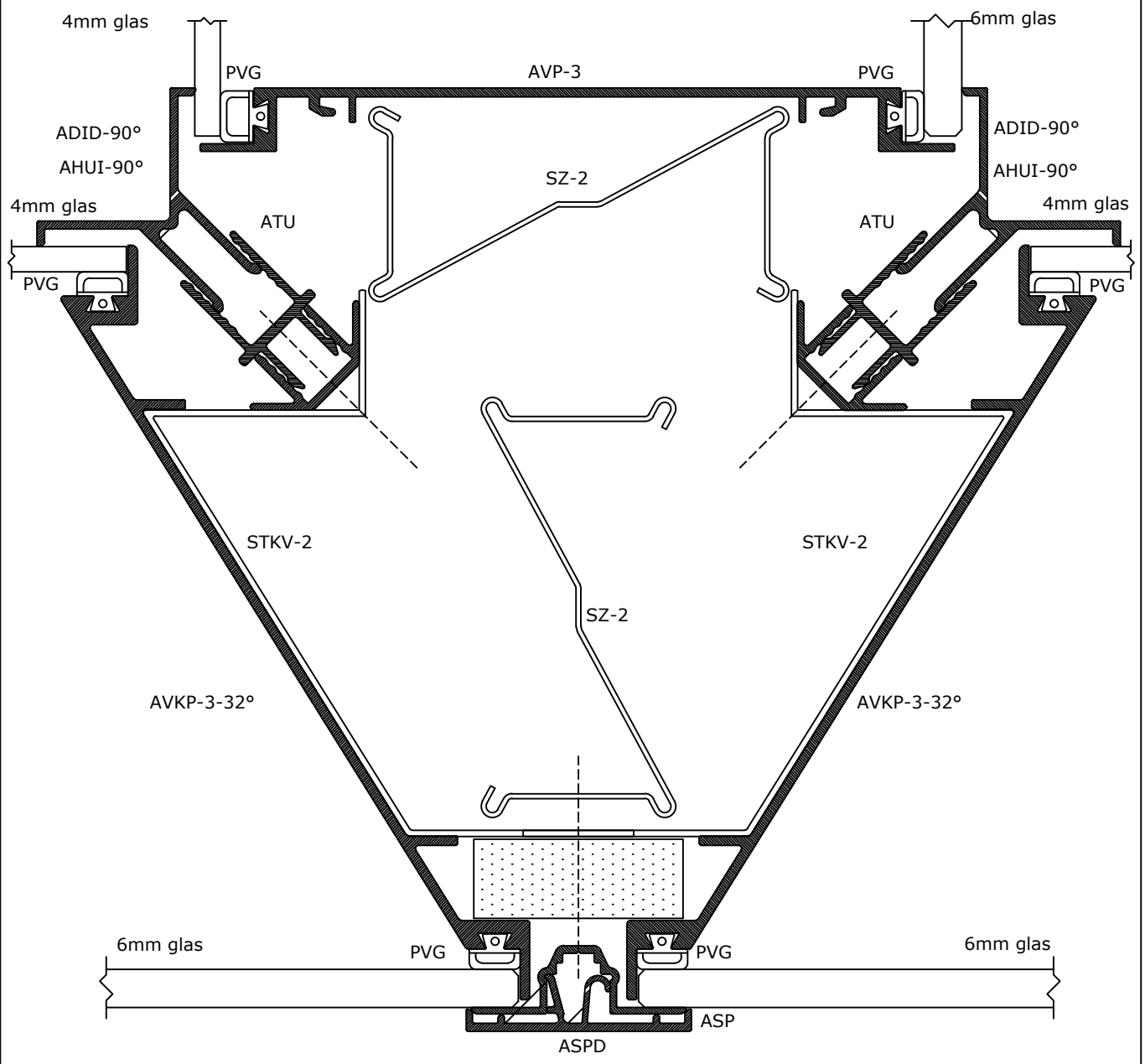

	DEKO Tlf./Tel: +45 43 55 77 11 www.deko.dk / www.deko.com	Projekt/Project: DEKO GV 1290	
	Sags Nr./Case No.:	Emne/Subject: V2I	Dato/Date:
Mål/Scale: 1:1		Revideret/Revision: 2016-10-07-VXX	Signatur Signature XX

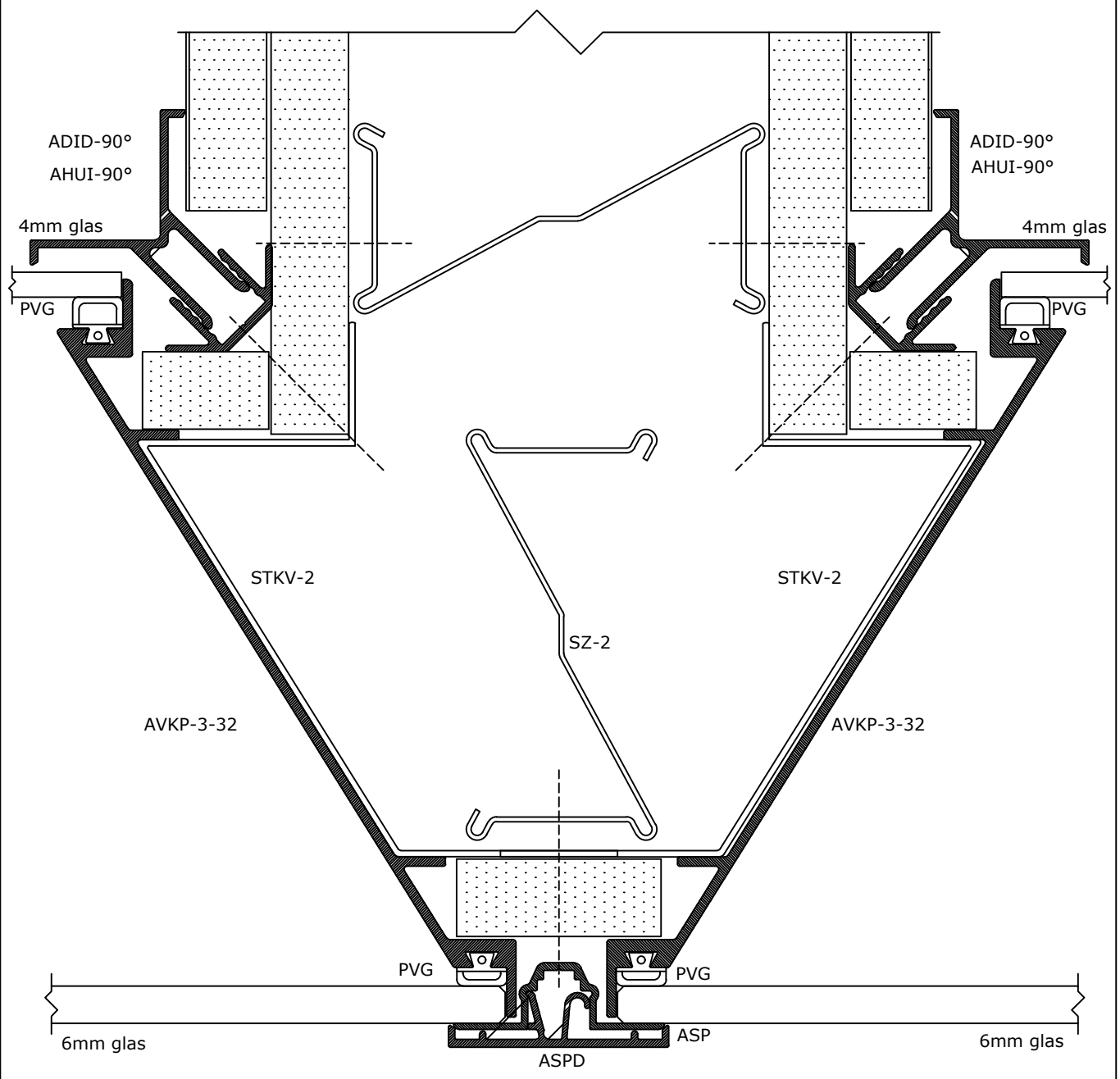

	DEKO Tlf./Tel: +45 43 55 77 11 www.deko.dk / www.deko.com	Projekt/Project: DEKO GV 1290	
	Sags Nr./Case No.:	Emne/Subject: V2J	Dato/Date:
Mål/Scale: 1:1		Revideret/Revision: 2016-10-07-VXX	Signatur Signature XX

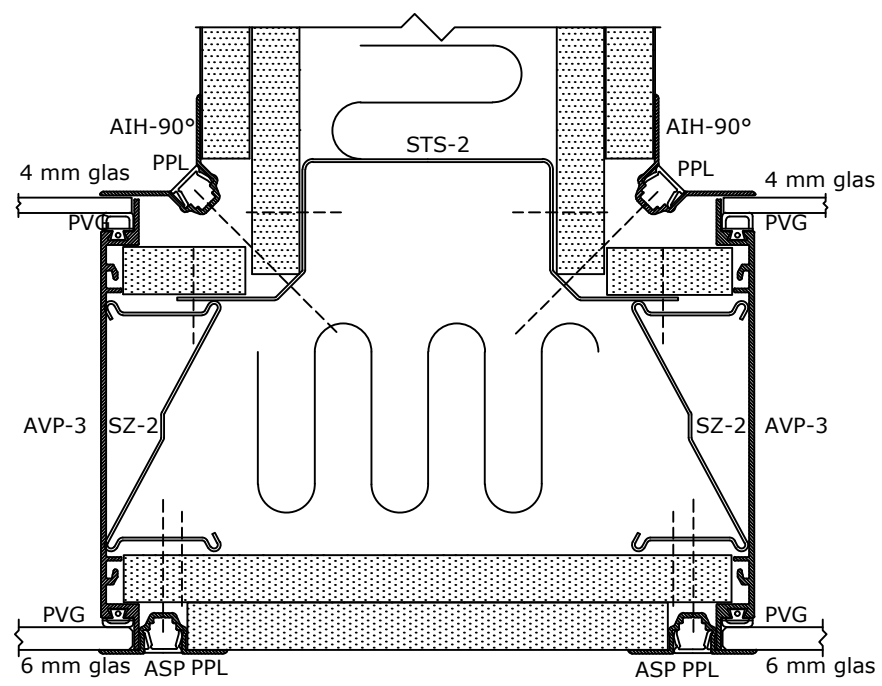

	DEKO Tlf./Tel: +45 43 55 77 11 www.deko.dk / www.deko.com	Projekt/Project: DEKO GV 1290	
	Sags Nr./Case No.: V2K	Emne/Subject:	Dato/Date:
Mål/Scale: 1:1		Revideret/Revision: 2016-10-07-VXX	Signatur Signature XX

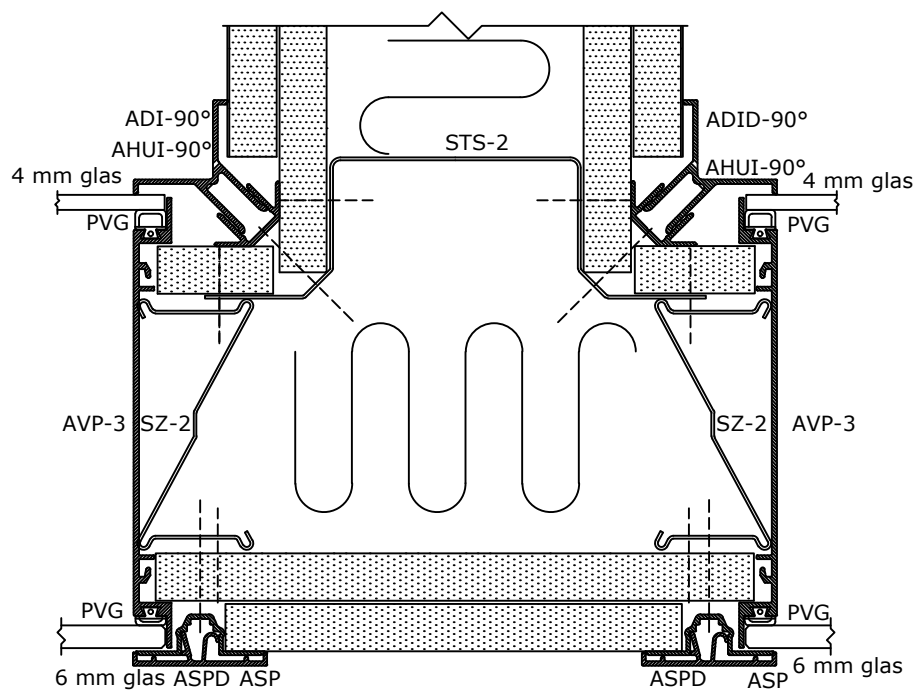

	DEKO Tlf./Tel: +45 43 55 77 11 www.deko.dk / www.deko.com	Projekt/Project: DEKO GV 1290	
	Sags Nr./Case No.: V2L	Emne/Subject: V2L	Dato/Date: 2016-10-07-VXX
Mål/Scale: 1:1		Revideret/Revision: 2016-10-07-VXX	

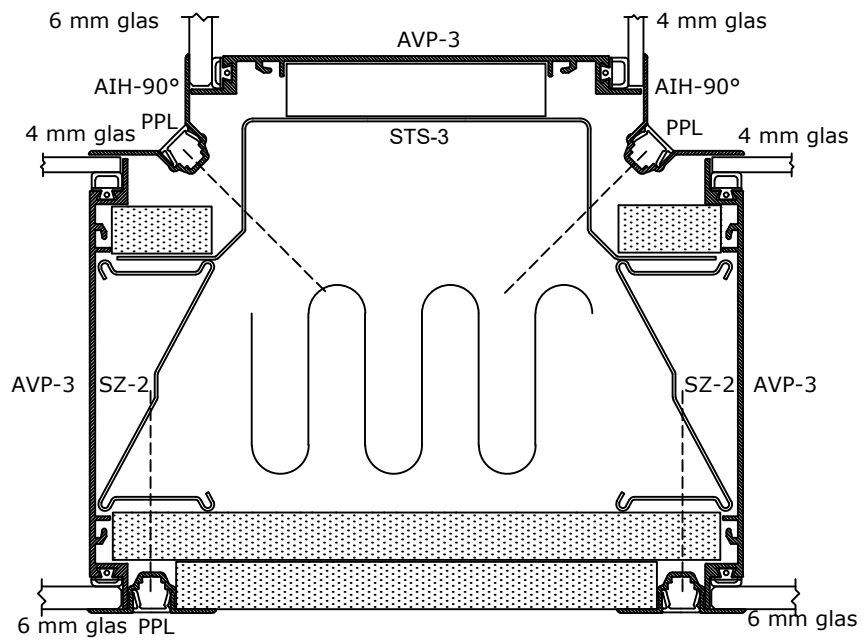

	DEKO Tlf./Tel: +45 43 55 77 11 www.deko.dk / www.deko.com	Projekt/Project: DEKO GV 1290	
	Sags Nr./Case No.:	Emne/Subject: V2M	Dato/Date:
Mål/Scale: 1:1		Revideret/Revision: 2016-10-07-VXX	Signatur Signature XX

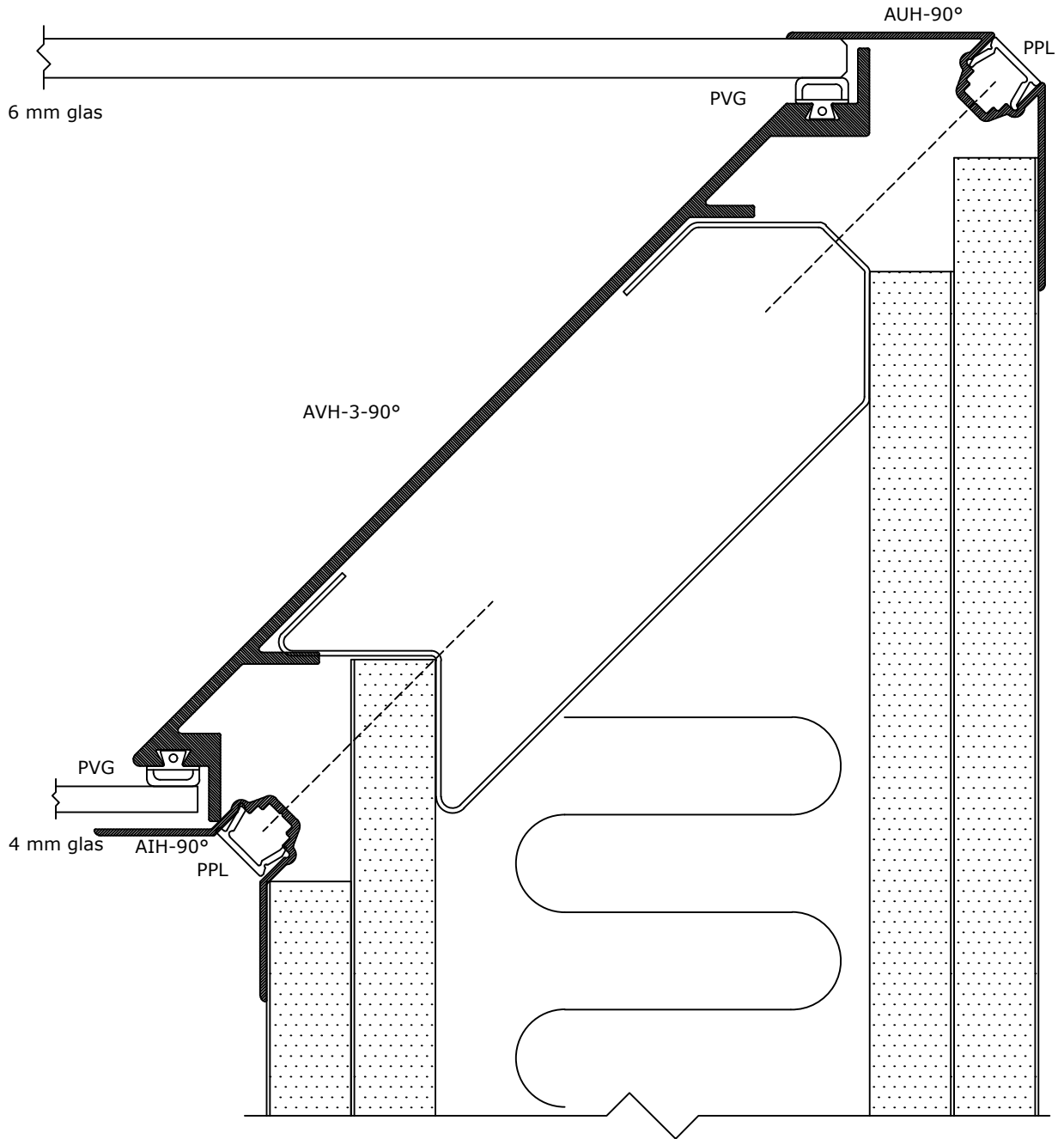

	DEKO Tlf./Tel: +45 43 55 77 11 www.deko.dk / www.deko.com	Projekt/Project: DEKO GV 1290	
	Sags Nr./Case No.: V3B	Emne/Subject: V3B	Dato/Date: 2016-10-07-VXX
Mål/Scale: 1:1		Revideret/Revision: 2016-10-07-VXX	Signatur Signature XX

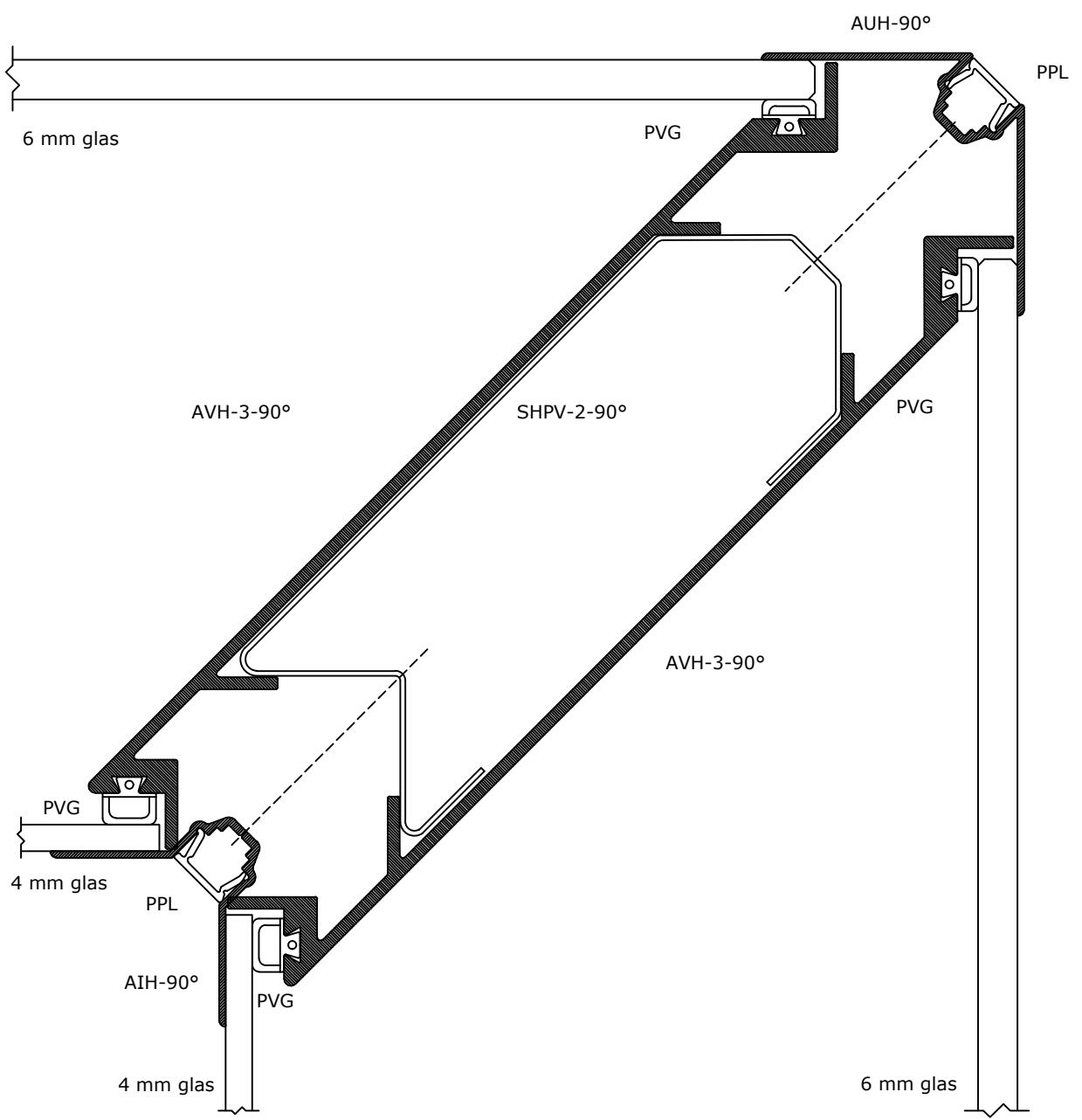

	DEKO Tlf./Tel: +45 43 55 77 11 www.deko.dk / www.deko.com	Projekt/Project: DEKO GV 1290	
	Sags Nr./Case No.:	Emne/Subject: V3C	Dato/Date:
Mål/Scale: 1:1		Revideret/Revision: 2016-10-07-VXX	Signatur Signature XX

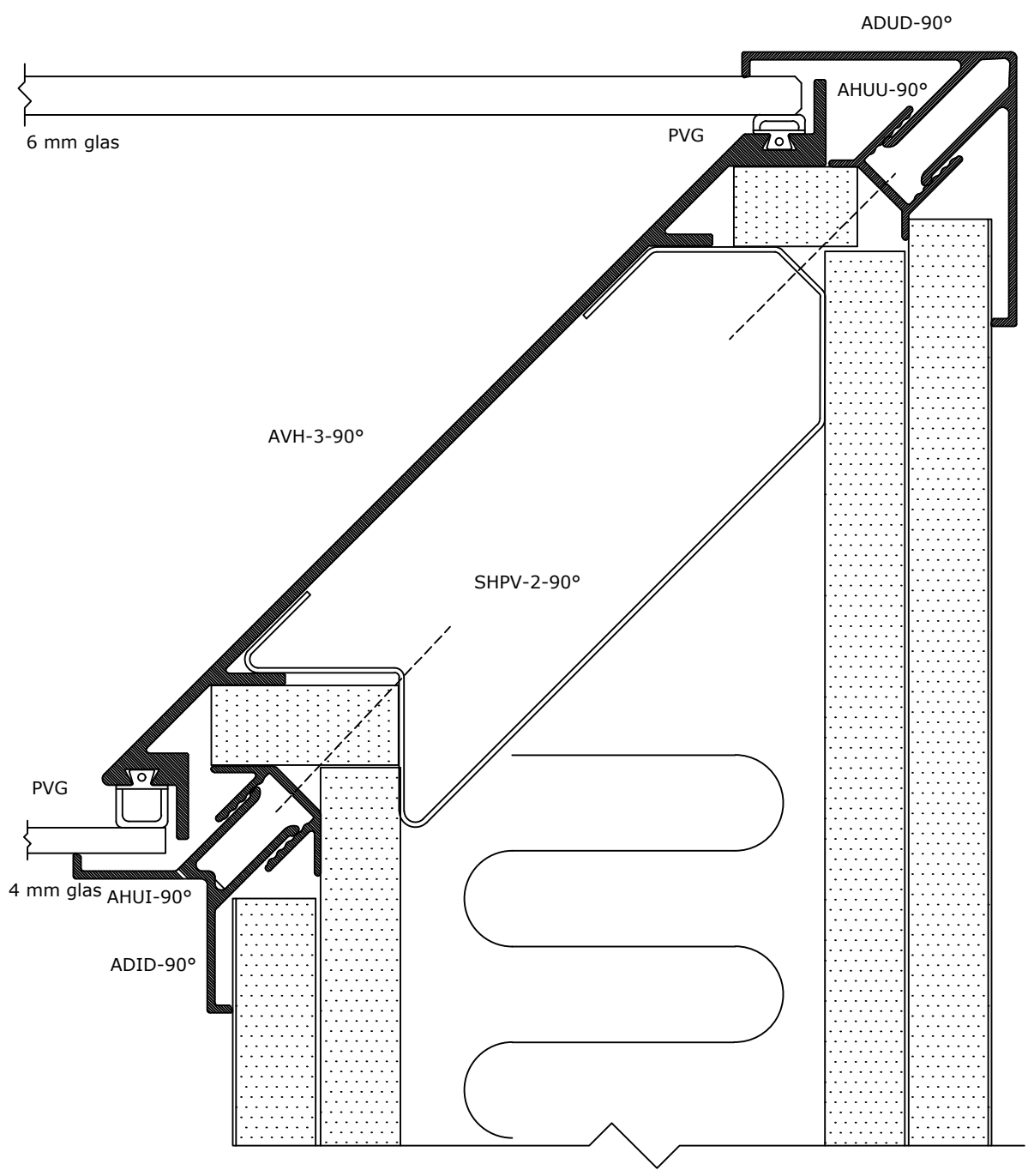

	DEKO Tlf./Tel: +45 43 55 77 11 www.deko.dk / www.deko.com	Projekt/Project: DEKO GV 1290	
	Sags Nr./Case No.:	Emne/Subject: V3E	Dato/Date:
Mål/Scale: 1:1		Revideret/Revision: 2016-10-07-VXX	Signatur Signature XX

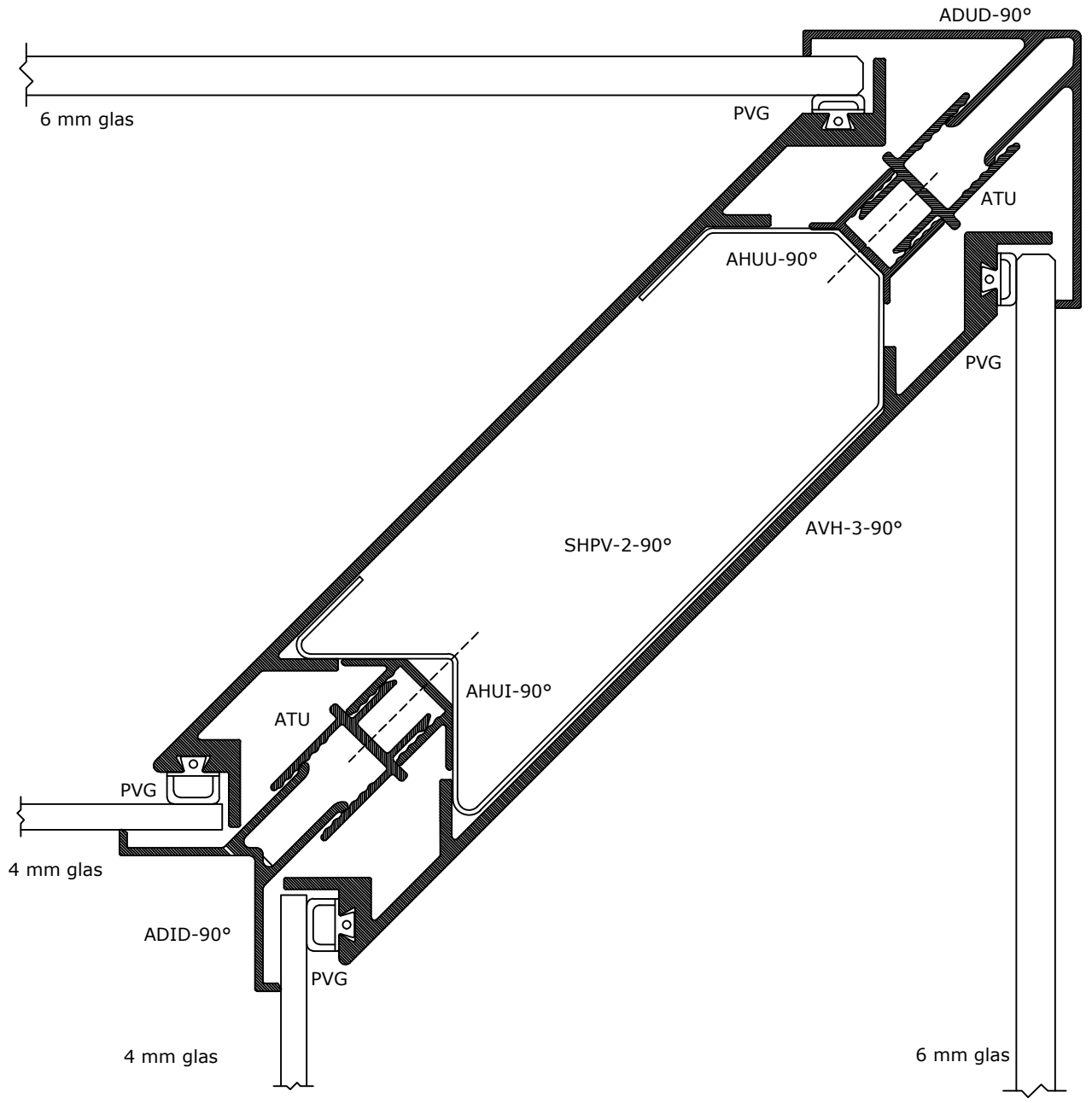

	DEKO Tlf./Tel: +45 43 55 77 11 www.deko.dk / www.deko.com	Projekt/Project: DEKO GV 1290	
	Sags Nr./Case No.: V3F	Emne/Subject: V3F	Dato/Date: 2016-10-07-VXX
Mål/Scale: 1:1		Revideret/Revision: 2016-10-07-VXX	Signatur Signature XX

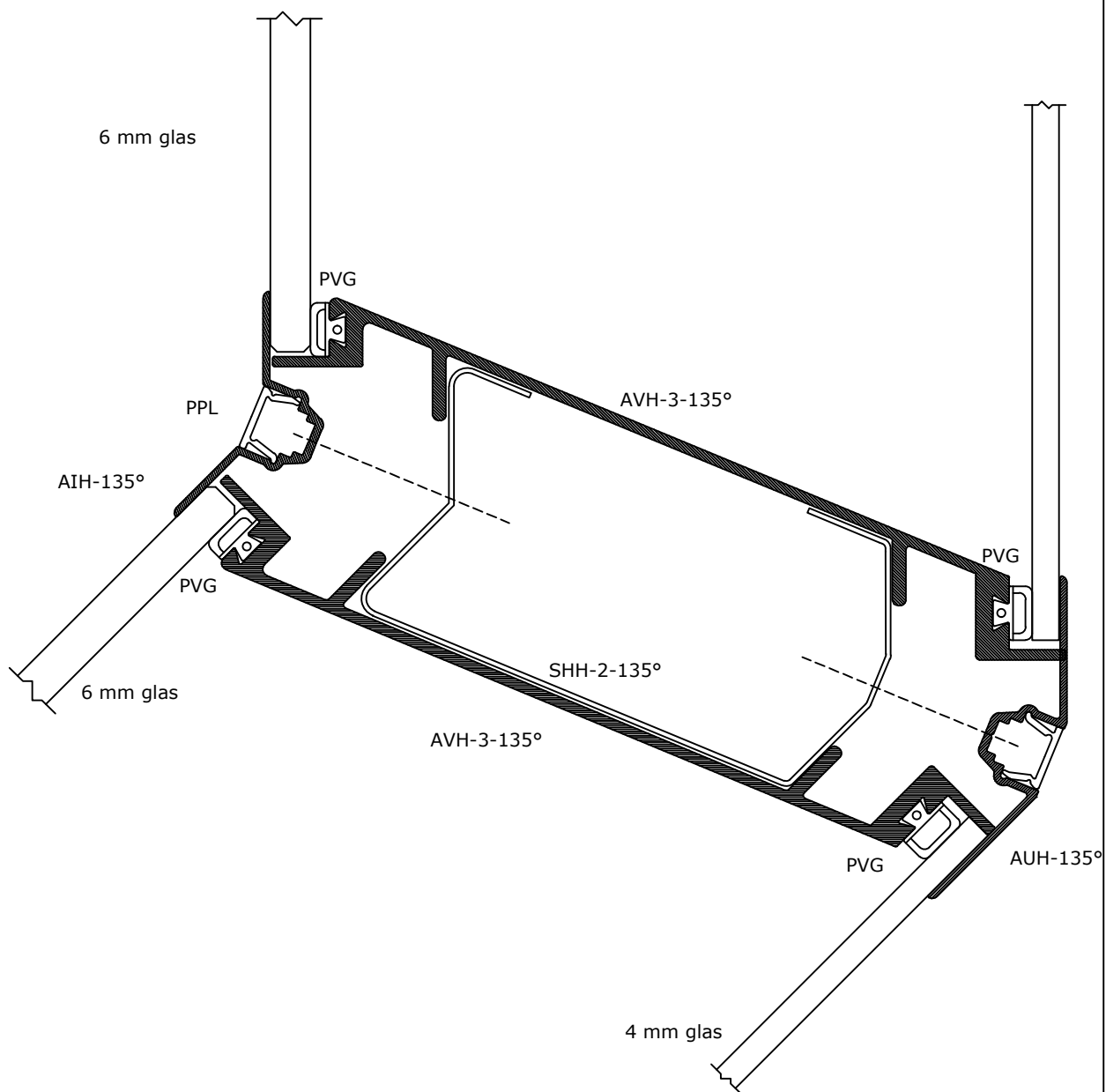

	DEKO Tlf./Tel: +45 43 55 77 11 www.deko.dk / www.deko.com	Projekt/Project: DEKO GV 1290	
	Sags Nr./Case No.: V4B	Emne/Subject: V4B	Dato/Date:
Mål/Scale: 1:1		Revideret/Revision: 2016-10-07-VXX	Signatur Signature XX

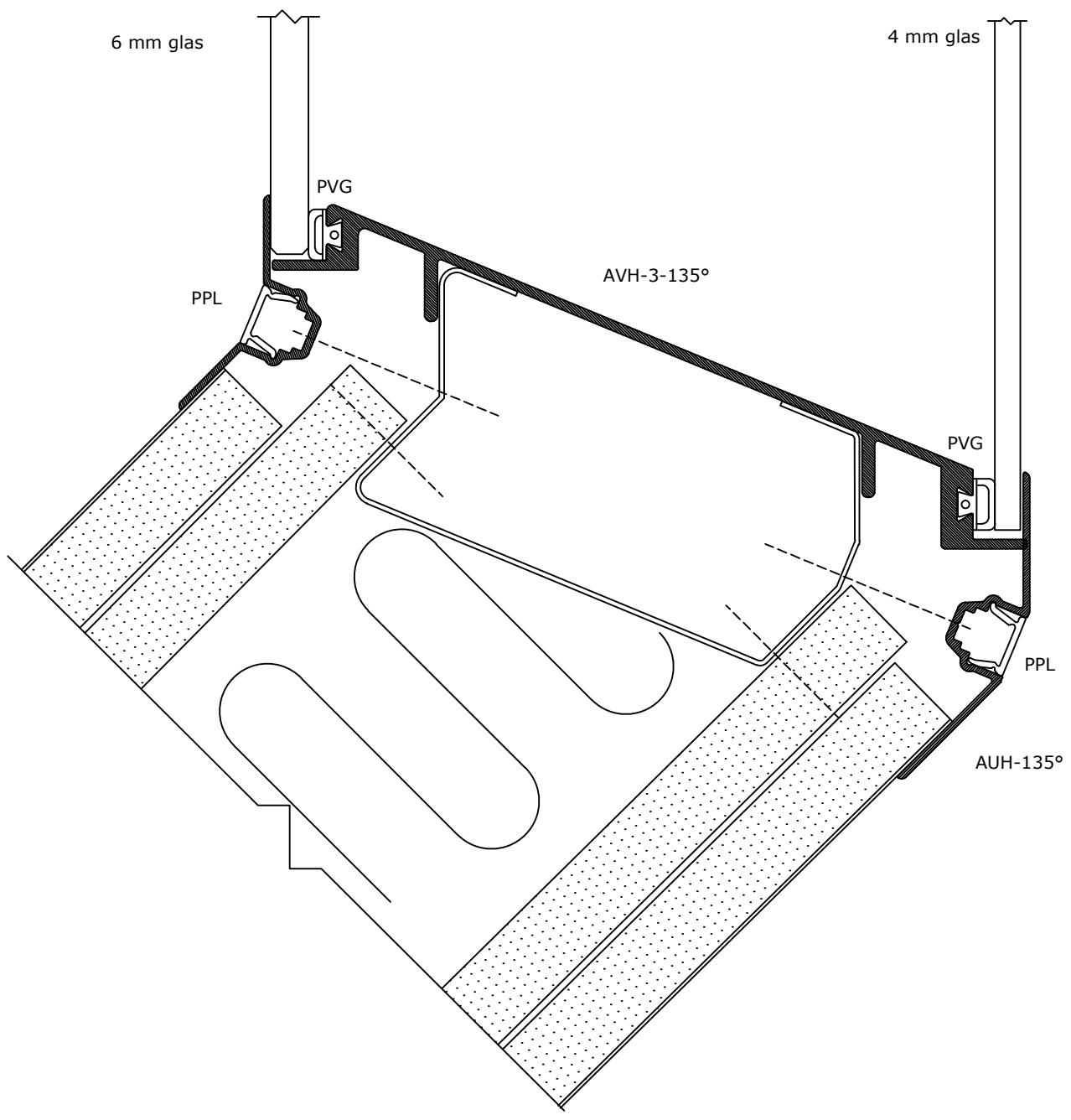

	DEKO Tlf./Tel: +45 43 55 77 11 www.deko.dk / www.deko.com	Projekt/Project: DEKO GV 1290	
	Sags Nr./Case No.:	Emne/Subject: V4C	Dato/Date:
Mål/Scale: 1:1		Revideret/Revision: 2016-10-07-VXX	Signatur Signature XX

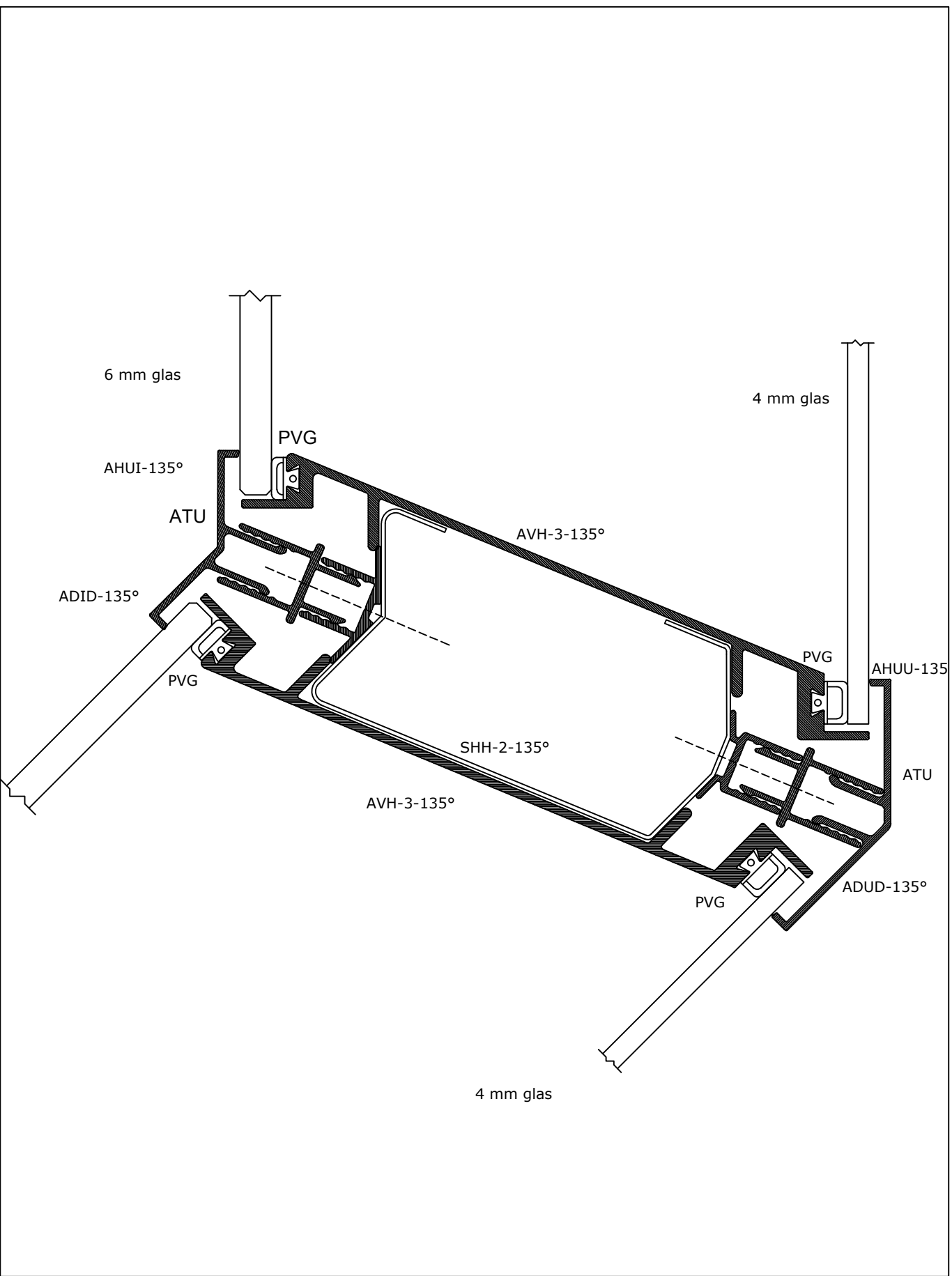

	DEKO Tlf./Tel: +45 43 55 77 11 www.deko.dk / www.deko.com	Projekt/Project: DEKO GV 1290	
	Sags Nr./Case No.:	Emne/Subject: V4D	Dato/Date:
Mål/Scale: 1:1		Revideret/Revision: 2016-10-07-VXX	Signatur Signature XX

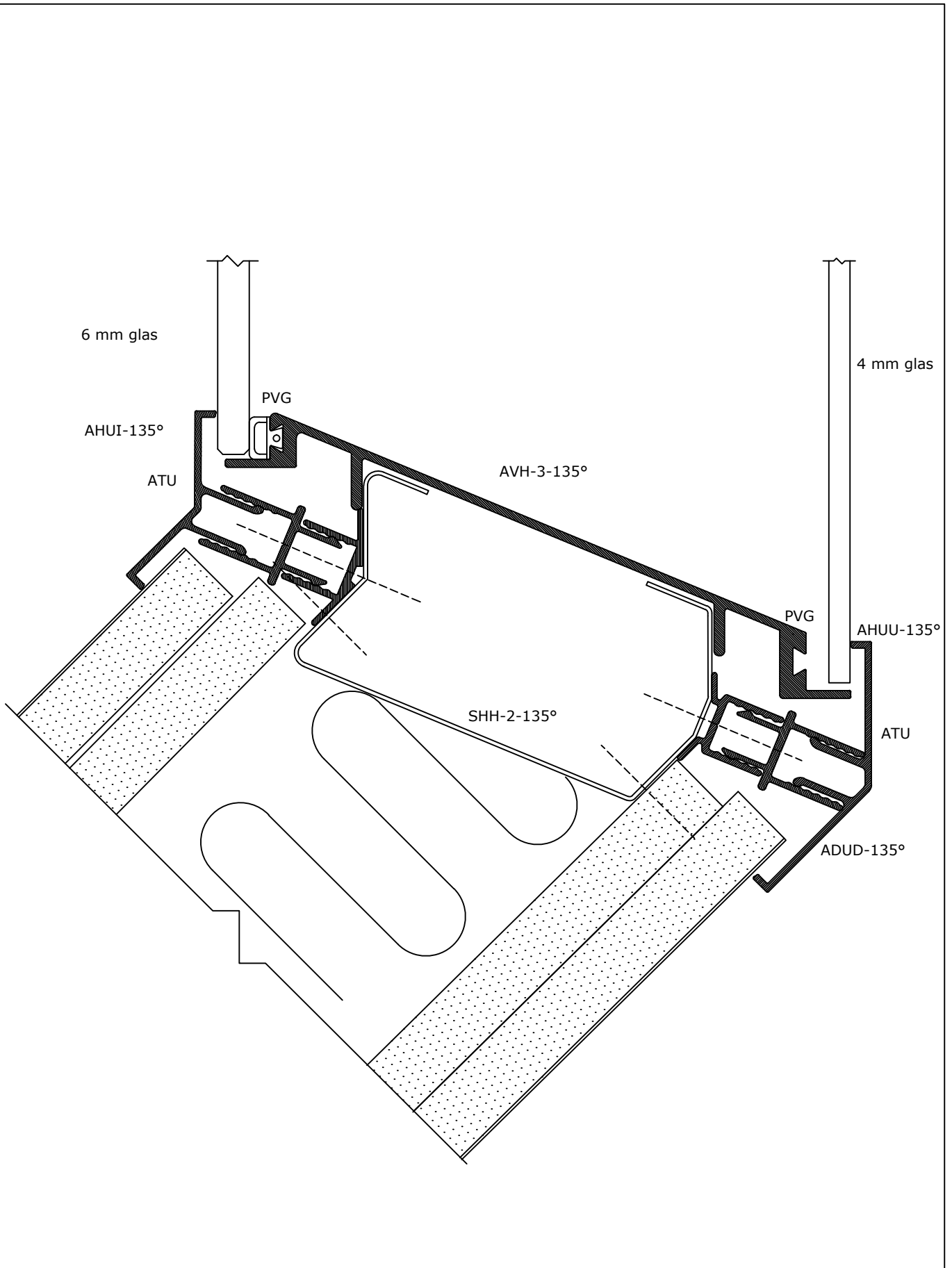

	DEKO Tlf./Tel: +45 43 55 77 11 www.deko.dk / www.deko.com	Projekt/Project: DEKO GV 1290	
	Sags Nr./Case No.:	Emne/Subject: V4E	Dato/Date:
Mål/Scale: 1:1		Revideret/Revision: 2016-10-07-VXX	Signatur Signature XX

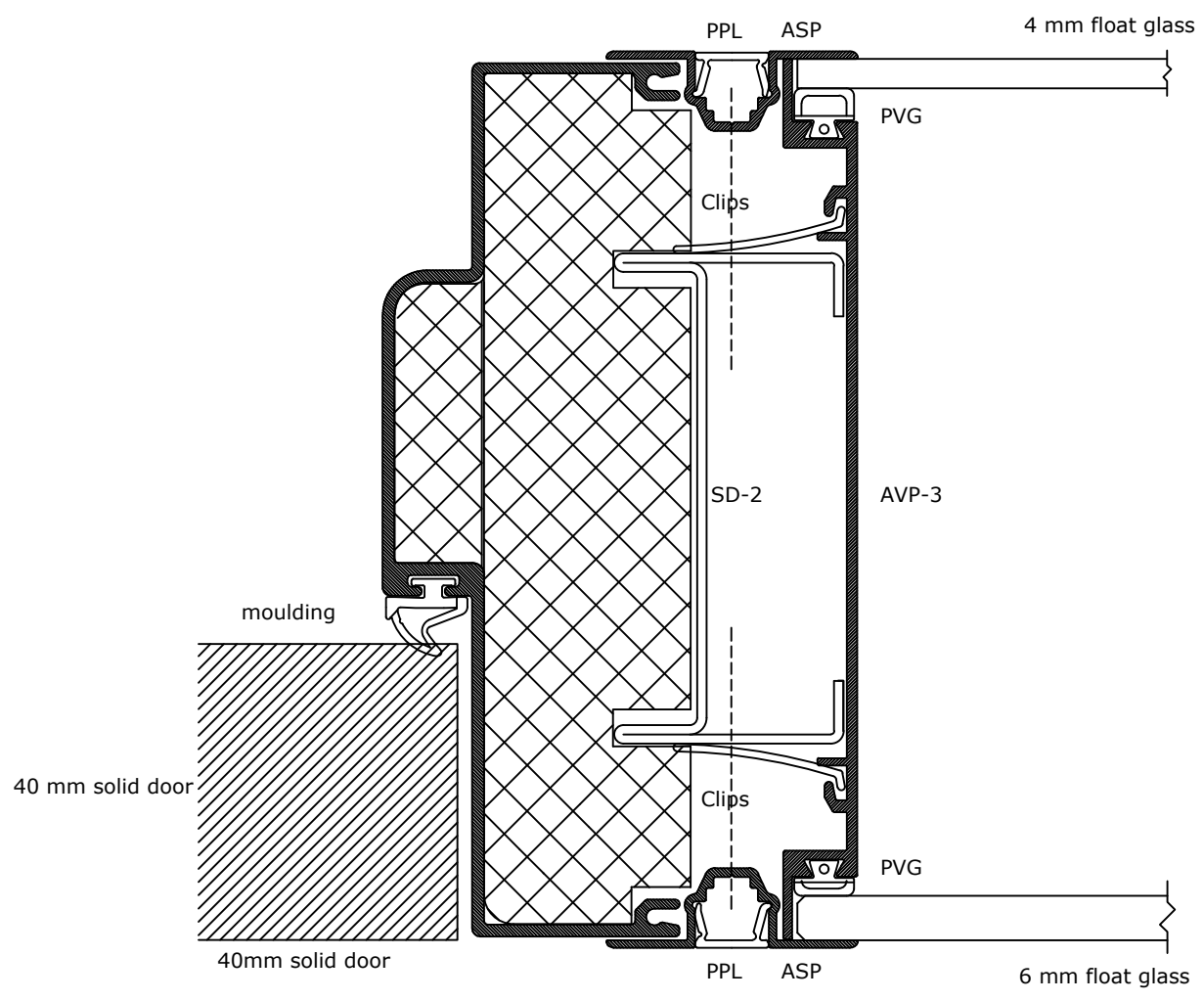

	DEKO Tlf./Tel: +45 43 55 77 11 www.deko.dk / www.deko.com	Projekt/Project: DEKO GV 1290	
	Sags Nr./Case No.:	Emne/Subject: V5C	Dato/Date:
Mål/Scale: 1:1		Revideret/Revision: 2016-10-07-VXX	Signatur Signature XX

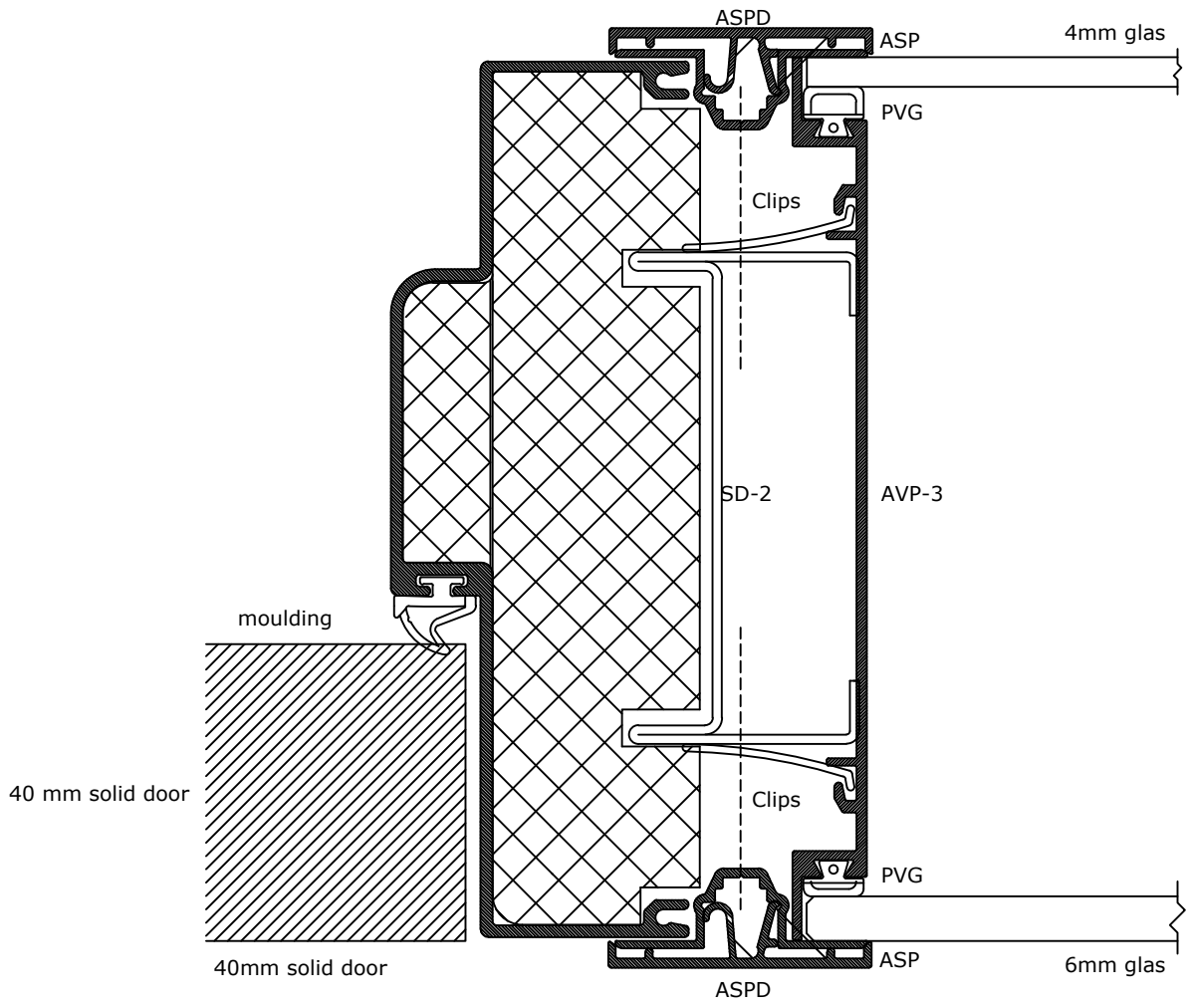

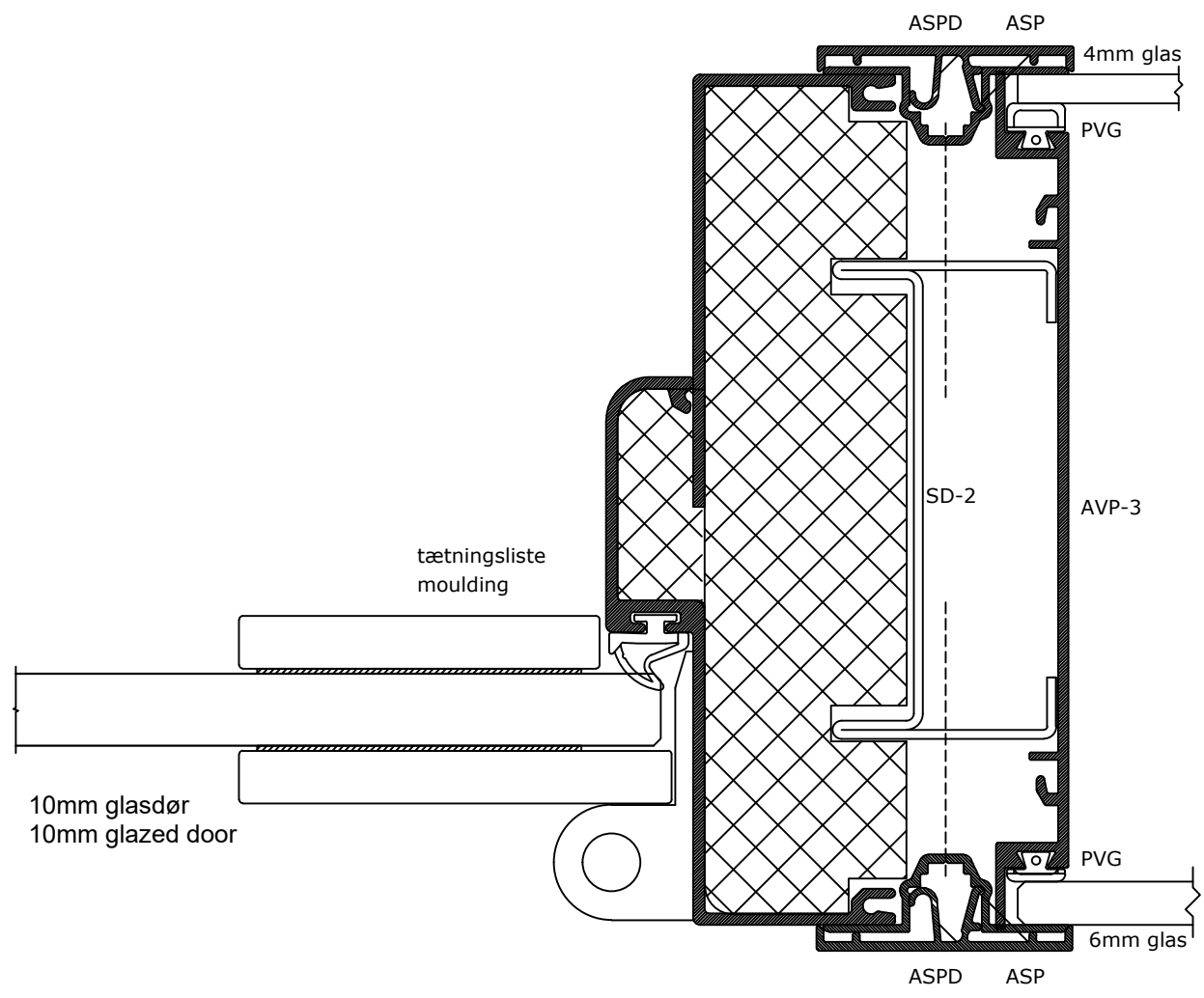

	DEKO Tlf./Tel: +45 43 55 77 11 www.deko.dk / www.deko.com	Projekt/Project: DEKO GV 1290	
	Sags Nr./Case No.: V5D	Emne/Subject:	Dato/Date:
Mål/Scale: 1:1		Revideret/Revision: 2016-10-07-VXX	Signatur Signature XX

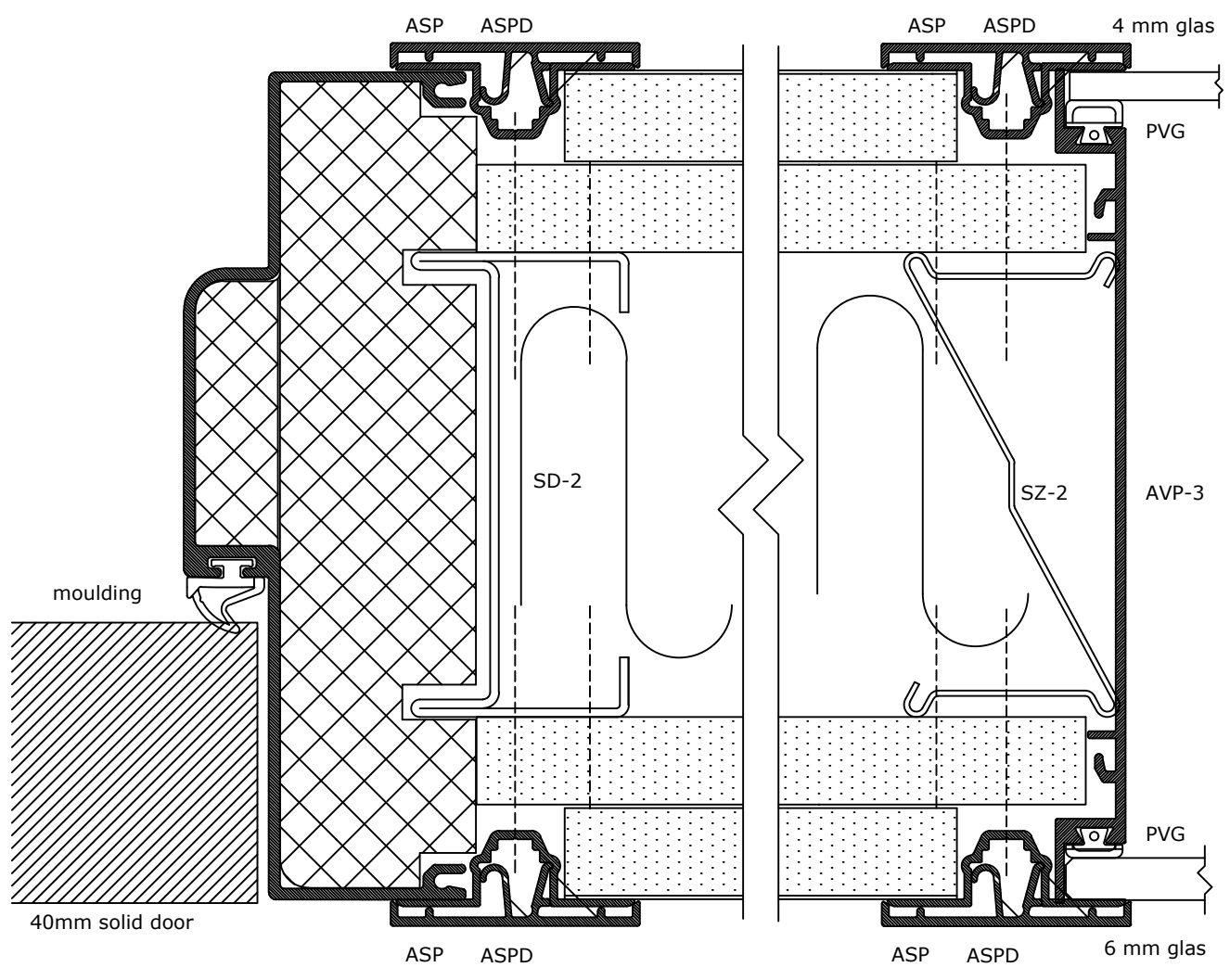

	DEKO Tlf./Tel: +45 43 55 77 11 www.deko.dk / www.deko.com	Projekt/Project: DEKO GV 1290	
	Sags Nr./Case No.:	Emne/Subject: V5F	Dato/Date:
Mål/Scale: 1:1		Revideret/Revision: 2016-10-07-VXX	Signatur Signature XX

Fast felt til installationer
 Solid section for installations



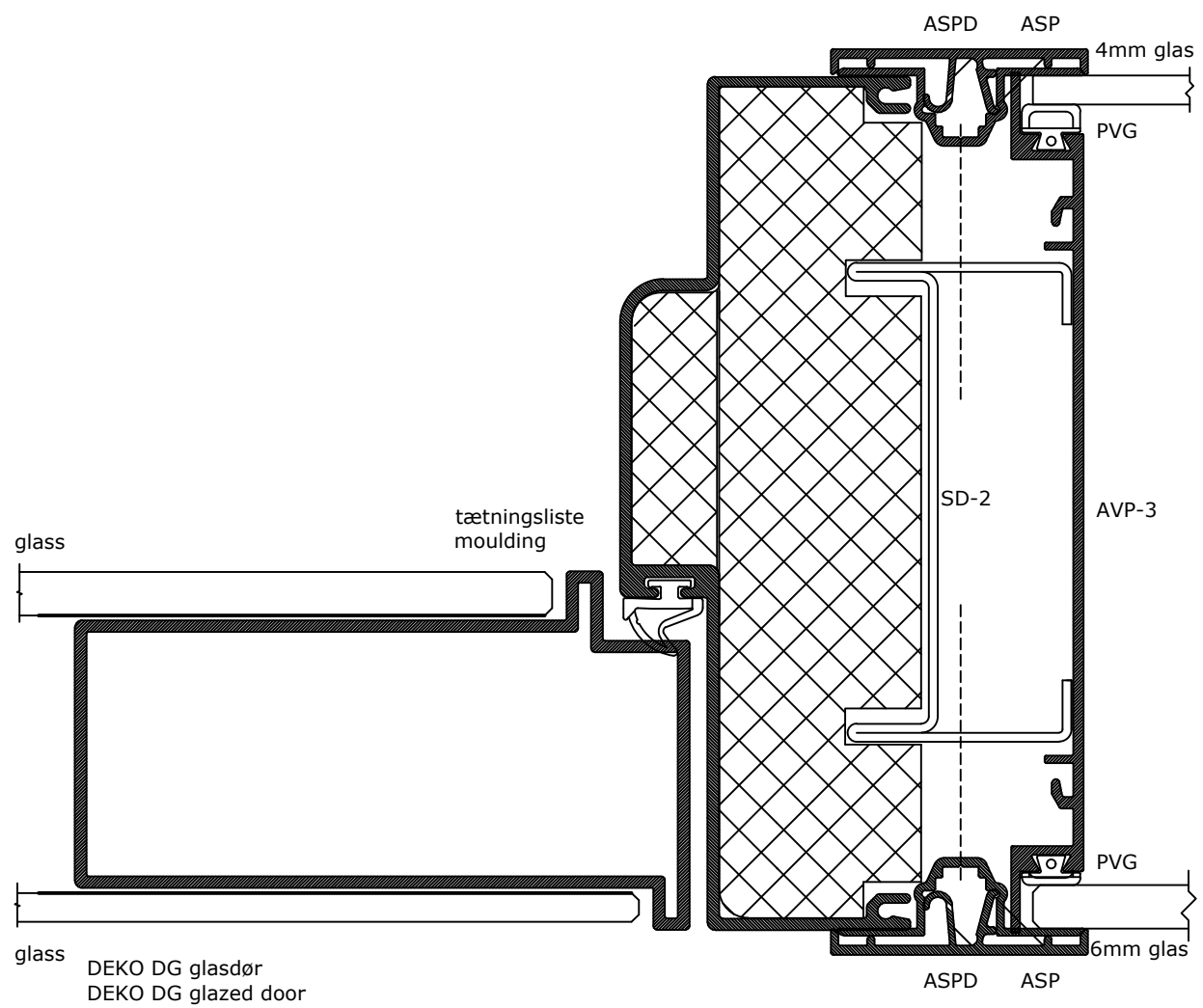

	DEKO Tlf./Tel: +45 43 55 77 11 www.deko.dk / www.deko.com	Projekt/Project: DEKO GV 1290	
	Sags Nr./Case No.: V5G	Emne/Subject:	Dato/Date:
Mål/Scale: 1:1		Revideret/Revision: 2016-10-07-VXX	Signatur Signature XX



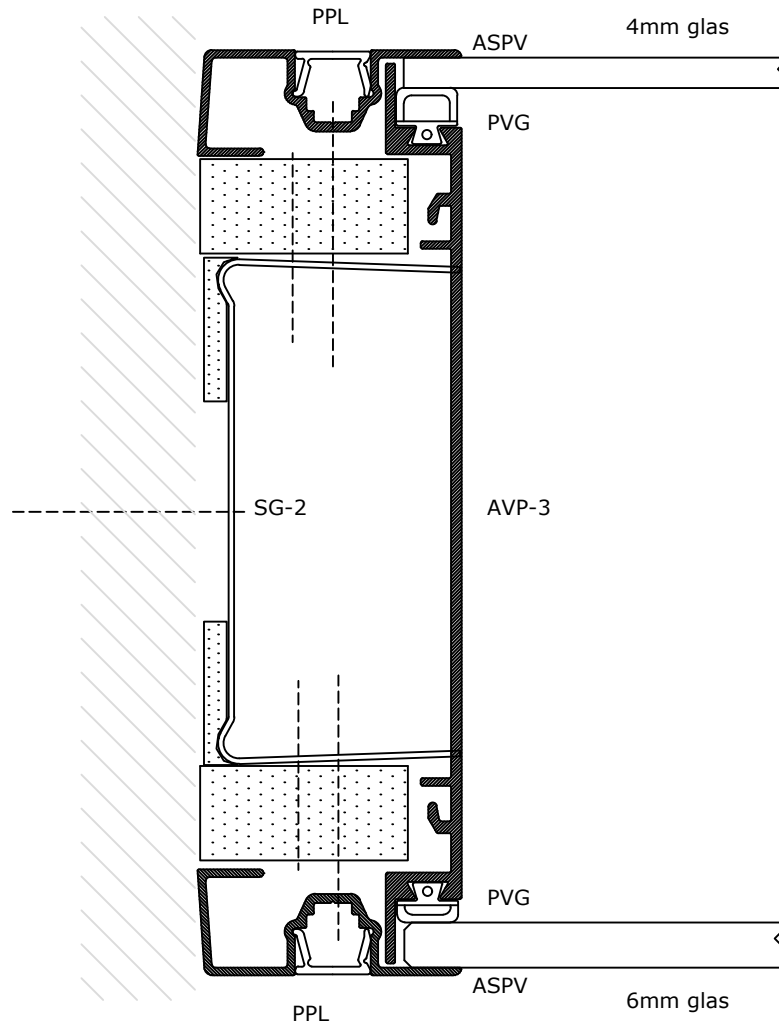

glass
 DEKO DG glasdør
 DEKO DG glazed door

	DEKO Tlf./Tel: +45 43 55 77 11 www.deko.dk / www.deko.com	Projekt/Project: DEKO GV 1290	
	Sags Nr./Case No.: V5H	Emne/Subject:	Dato/Date:
Mål/Scale: 1:1		Revideret/Revision: 2016-10-07-VXX	Signatur Signature XX

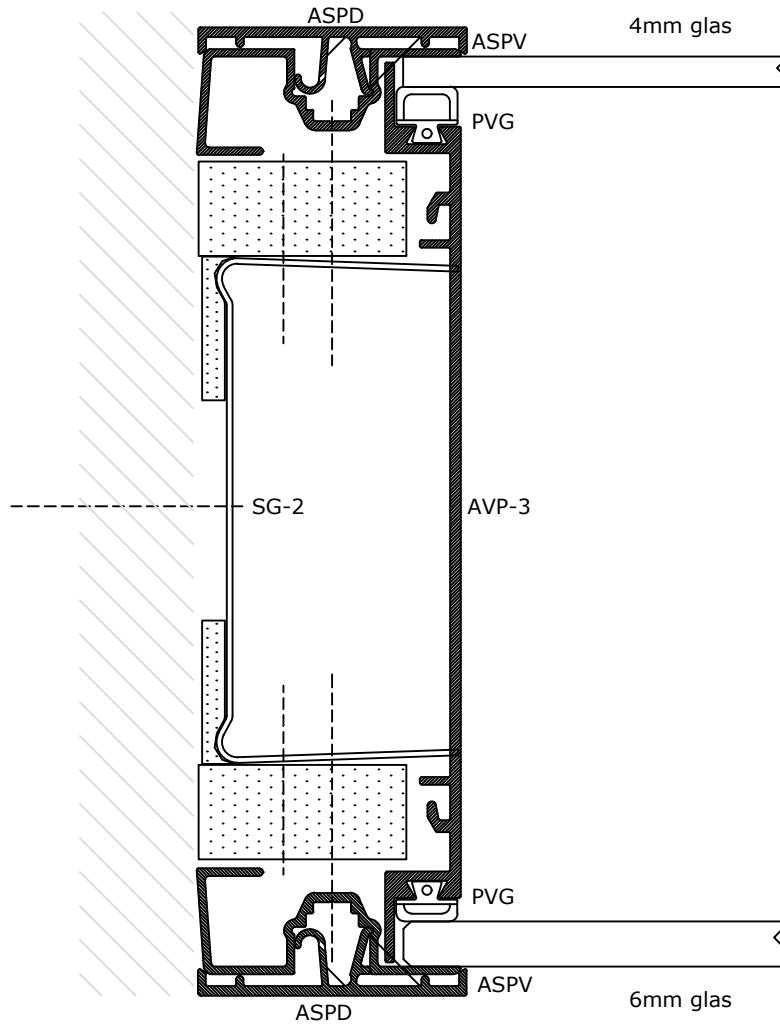

	DEKO Tlf./Tel: +45 43 55 77 11 www.deko.dk / www.deko.com	Projekt/Project: DEKO GV 1290	
	Sags Nr./Case No.: V7D	Emne/Subject:	Dato/Date:
Mål/Scale: 1:1		Revideret/Revision: 2016-10-07-VXX	Signatur Signature XX



	DEKO Tlf./Tel: +45 43 55 77 11 www.deko.dk / www.deko.com	Projekt/Project: DEKO GV 1290	
	Sags Nr./Case No.:	Emne/Subject: V7E	Dato/Date:
Mål/Scale: 1:1		Revideret/Revision: 2016-10-07-VXX	Signatur Signature XX

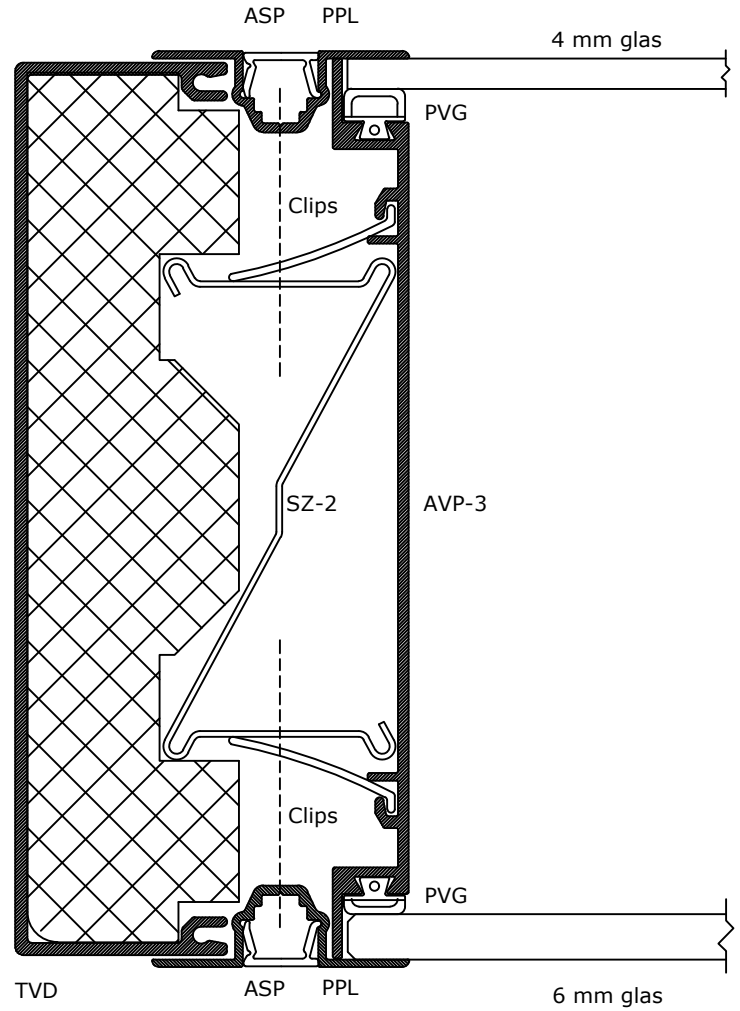

	DEKO Tlf./Tel: +45 43 55 77 11 www.deko.dk / www.deko.com	Projekt/Project: DEKO GV 1290	
	Sags Nr./Case No.:	Emne/Subject: V8A	Dato/Date:
Mål/Scale: 1:1		Revideret/Revision: 2016-10-07-VXX	Signatur Signature XX

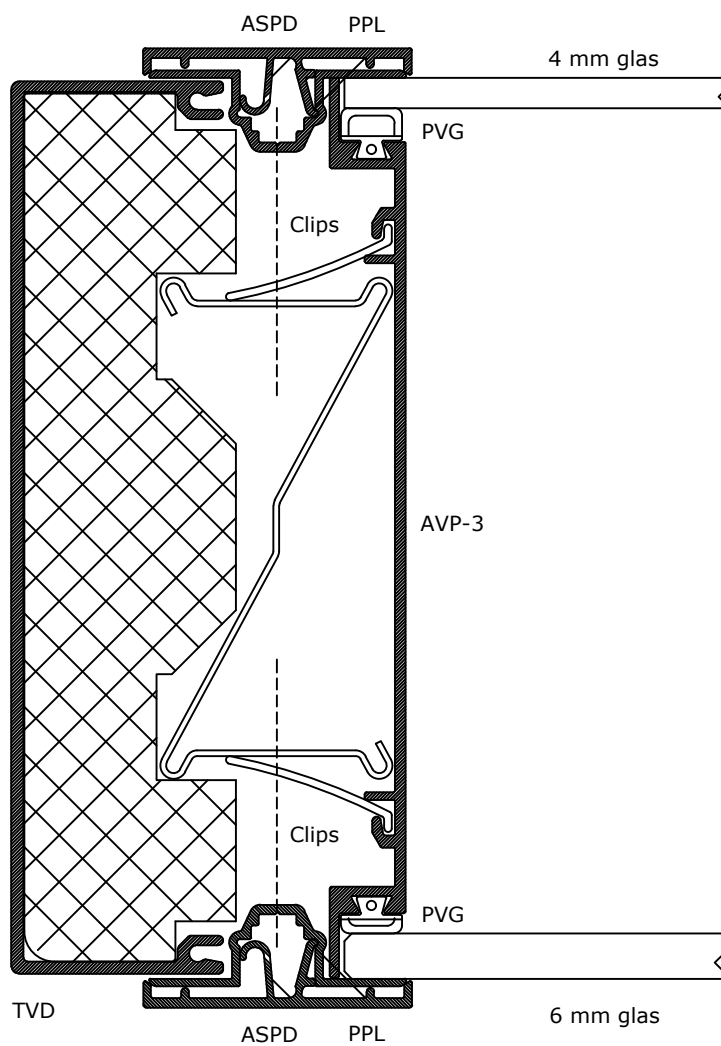

	DEKO Tlf./Tel: +45 43 55 77 11 www.deko.dk / www.deko.com	Projekt/Project: DEKO GV 1290	
	Sags Nr./Case No.:	Emne/Subject: V8C	Dato/Date:
Mål/Scale: 1:1		Revideret/Revision: 2016-10-07-VXX	Signatur Signature XX

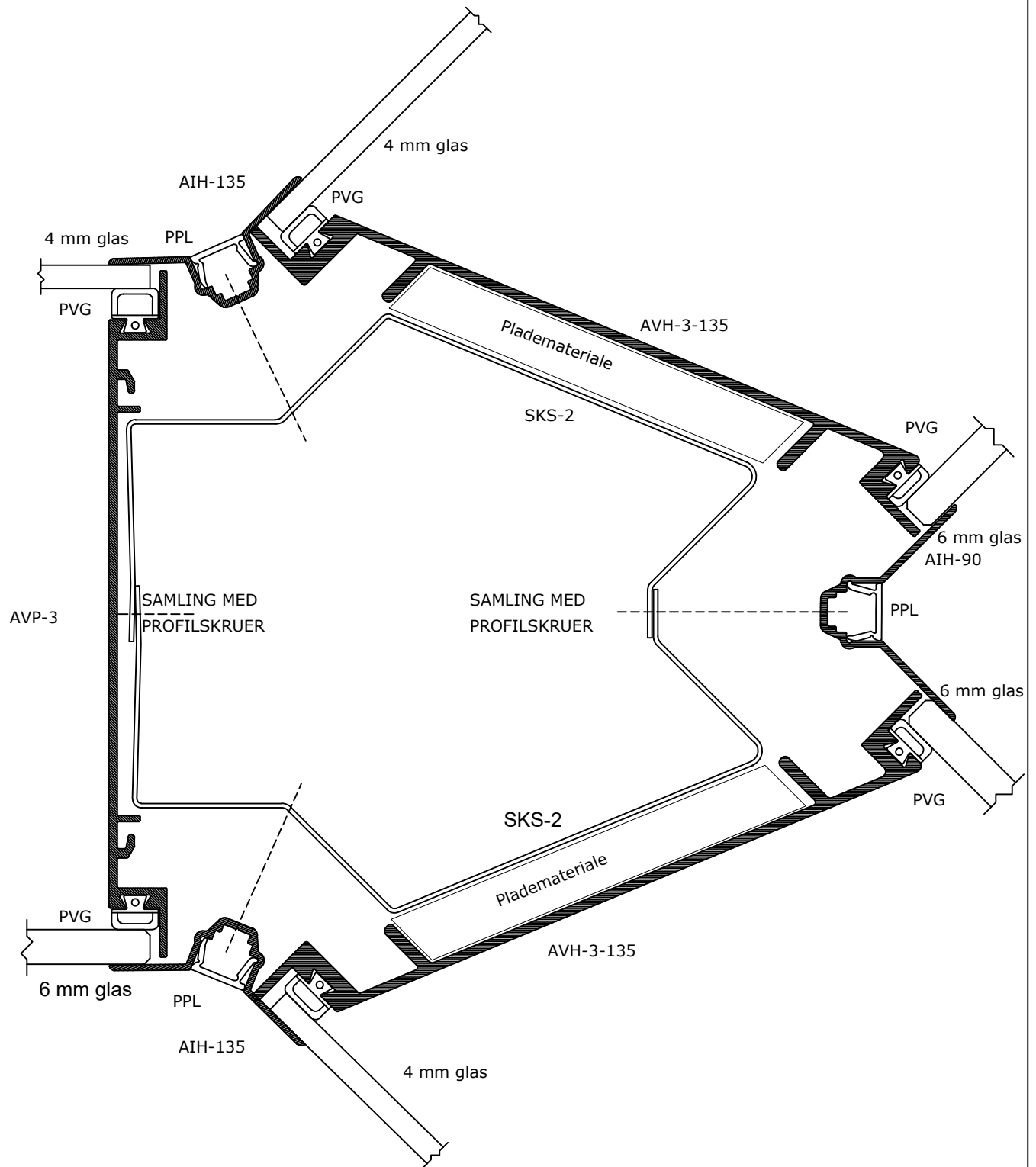

	DEKO Tlf./Tel: +45 43 55 77 11 www.deko.dk / www.deko.com	Projekt/Project: DEKO GV 1290	
	Sags Nr./Case No.:	Emne/Subject: V9B	Dato/Date:
Mål/Scale: 1:1		Revideret/Revision: 2016-10-07-VXX	Signatur Signature XX

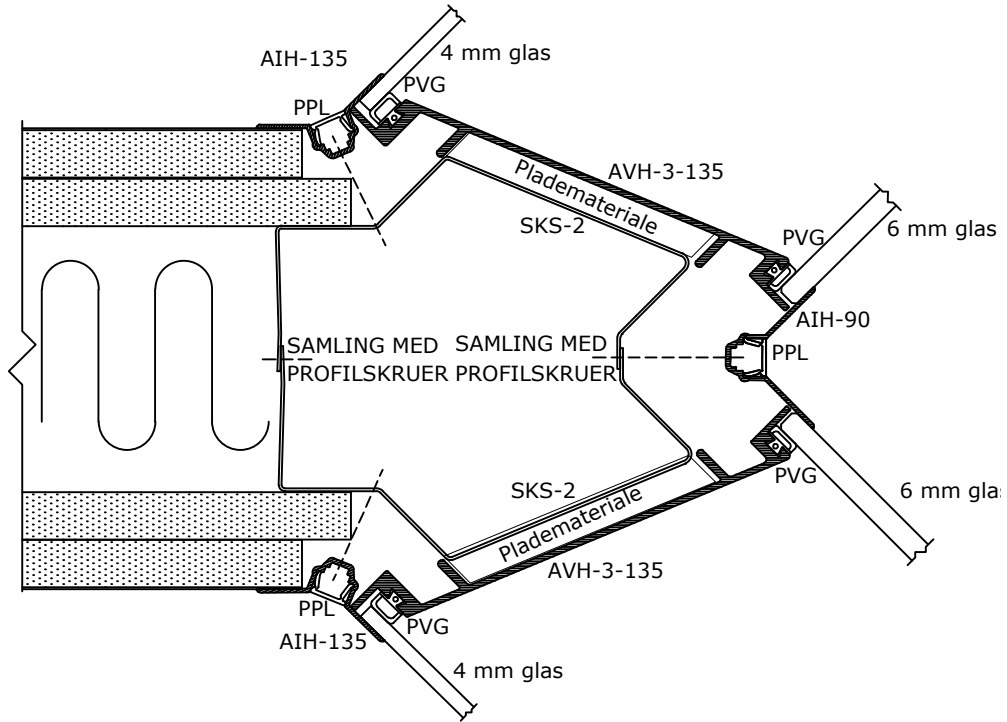

	DEKO Tlf./Tel: +45 43 55 77 11 www.deko.dk / www.deko.com	Projekt/Project: DEKO GV 1290	
	Sags Nr./Case No.: V9C	Emne/Subject:	Dato/Date:
Mål/Scale: 1:2		Revideret/Revision: 2016-10-07-VXX	Signatur Signature XX

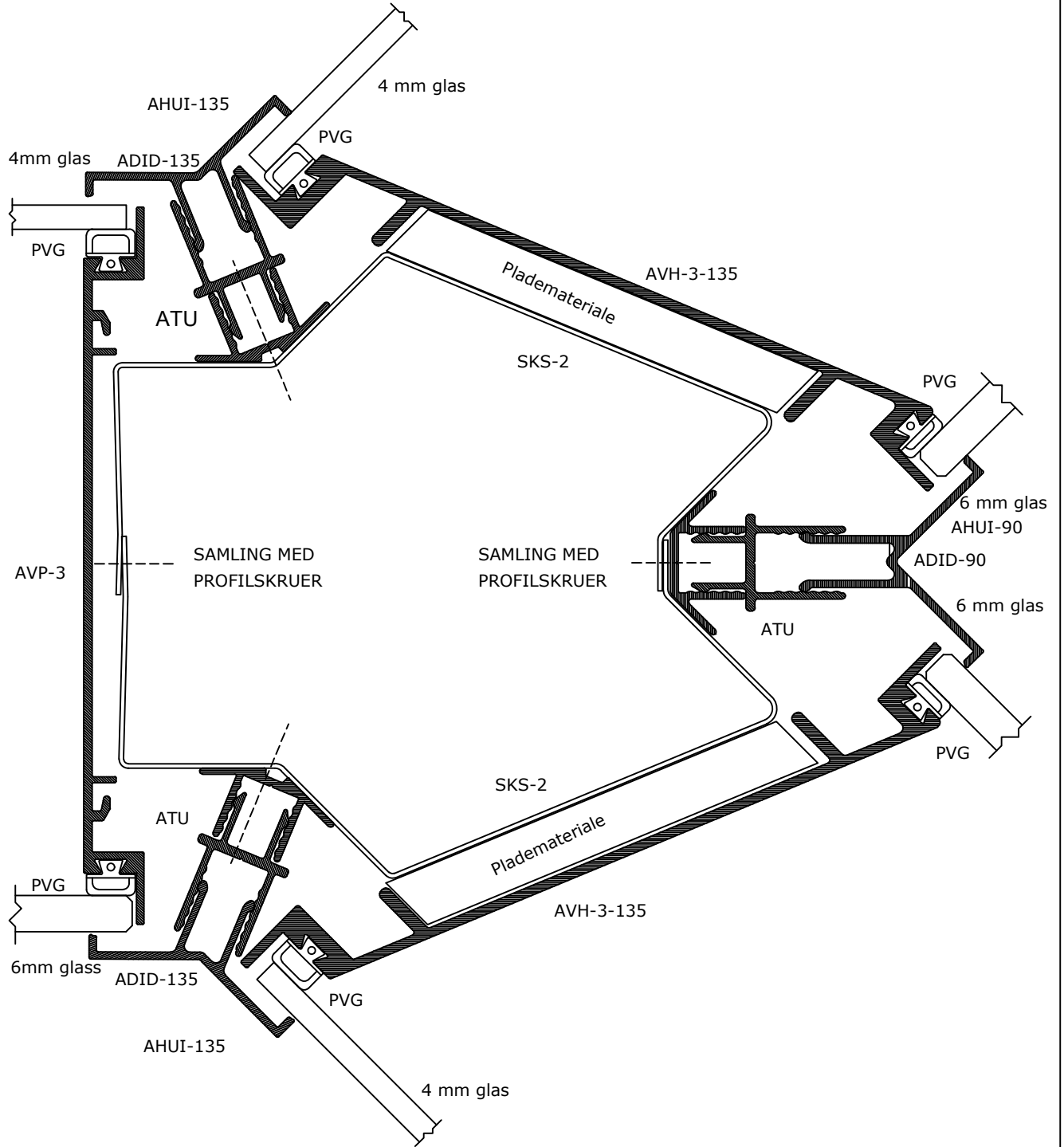

	DEKO Tlf./Tel: +45 43 55 77 11 www.deko.dk / www.deko.com	Projekt/Project: DEKO GV 1290	
	Sags Nr./Case No.: V9D	Emne/Subject:	Dato/Date:
Mål/Scale: 1:1		Revideret/Revision: 2016-10-07-VXX	Signatur Signature XX

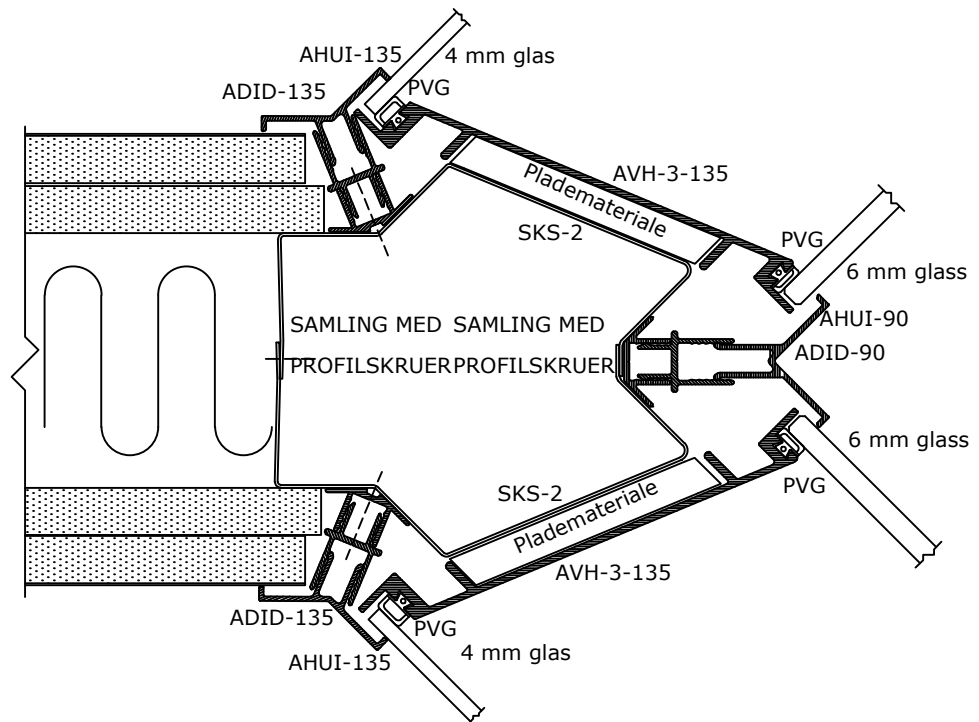

	DEKO Tlf./Tel: +45 43 55 77 11 www.deko.dk / www.deko.com	Projekt/Project: DEKO GV 1290	
	Sags Nr./Case No.: V9E	Emne/Subject:	Dato/Date:
Mål/Scale: 1:2		Revideret/Revision: 2016-10-07-VXX	Signatur Signature XX