

**DEKO**

**Tlf./Tel:** +45 43 55 77 11  
www.deko.dk / www.deko.com

**Projekt/Project:**

DEKO PV 590

**Sags Nr./Case No.:**

**Emne/Subject:**

Lofttilslutning

L1A

**Dato/Date:**

**Tegn. Nr. Sheet No.** 1/1

**Mål/Scale**  
1:1

**Revideret/Revision:**  
2016-05-02-V01

**Signatur Signature** OP/EZ

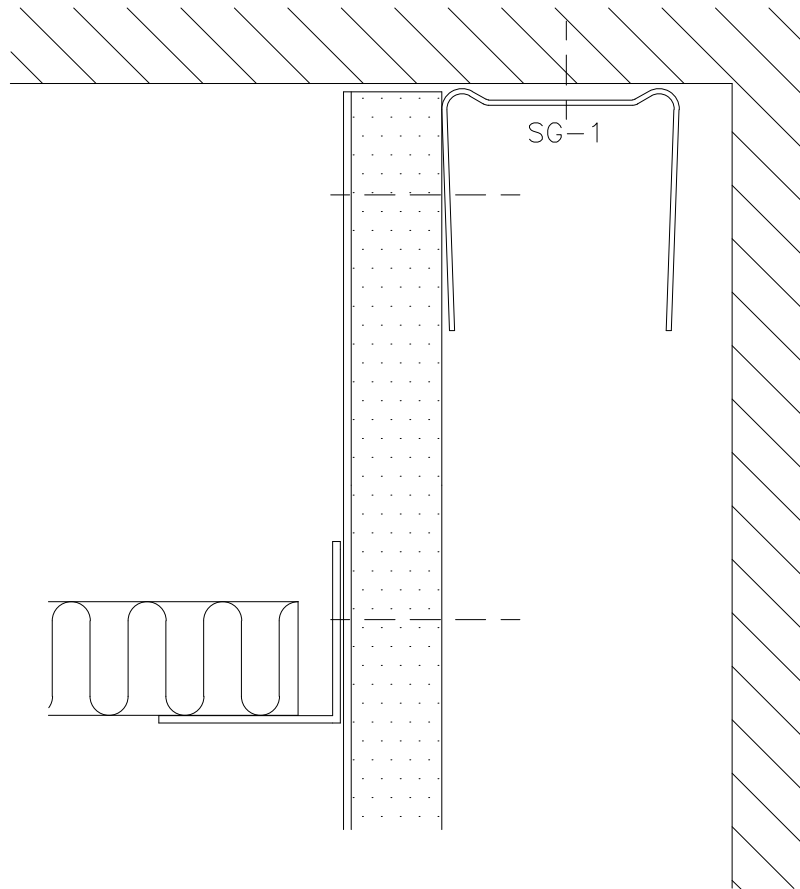

	<b>DEKO</b>	<b>Projekt/Project:</b>	
	<b>Tlf./Tel:</b> +45 43 55 77 11 www.deko.dk / www.deko.com	DEKO PV 590	
<b>Sags Nr./Case No.:</b>	<b>Emne/Subject:</b>	<b>Dato/Date:</b>	<b>Tegn. Nr. Sheet No.</b> 1/1
<b>Mål/Scale</b> 1:1	Lofttilslutning L1B	<b>Revideret/Revision:</b> 2016-05-02-V01	<b>Signatur Signature</b> OP/EZ

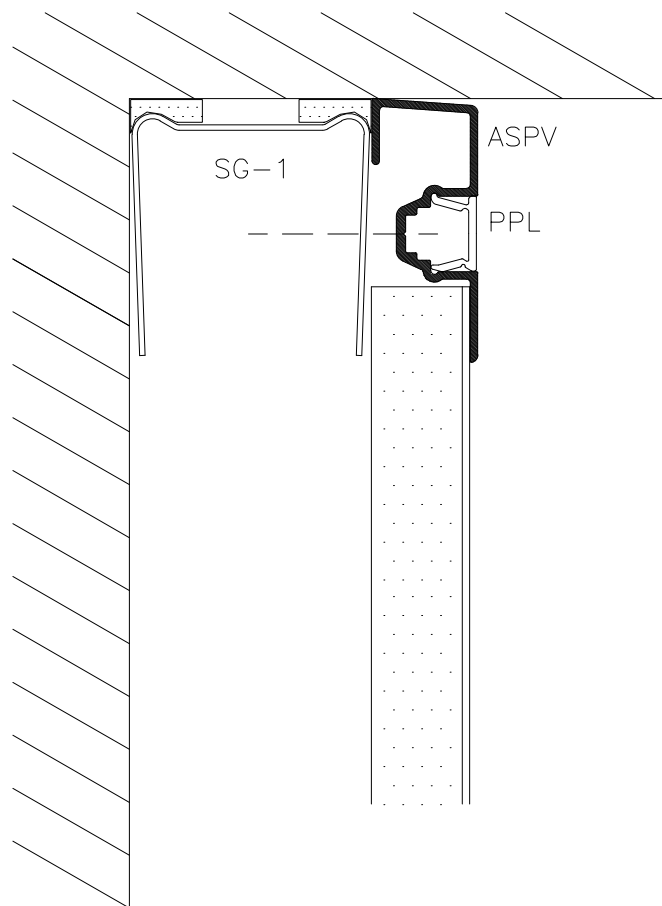

**DEKO**

**Tlf./Tel:** +45 43 55 77 11  
www.deko.dk / www.deko.com

**Projekt/Project:**

DEKO PV 590

**Sags Nr./Case No.:**

**Emne/Subject:**

Lofttilslutning

L1C

**Dato/Date:**

**Tegn. Nr.**

**Sheet No.** 1/1

**Mål/Scale**

1:1

**Revideret/Revision:**

2016-05-02-V01

**Signatur**

**Signature** OP/EZ

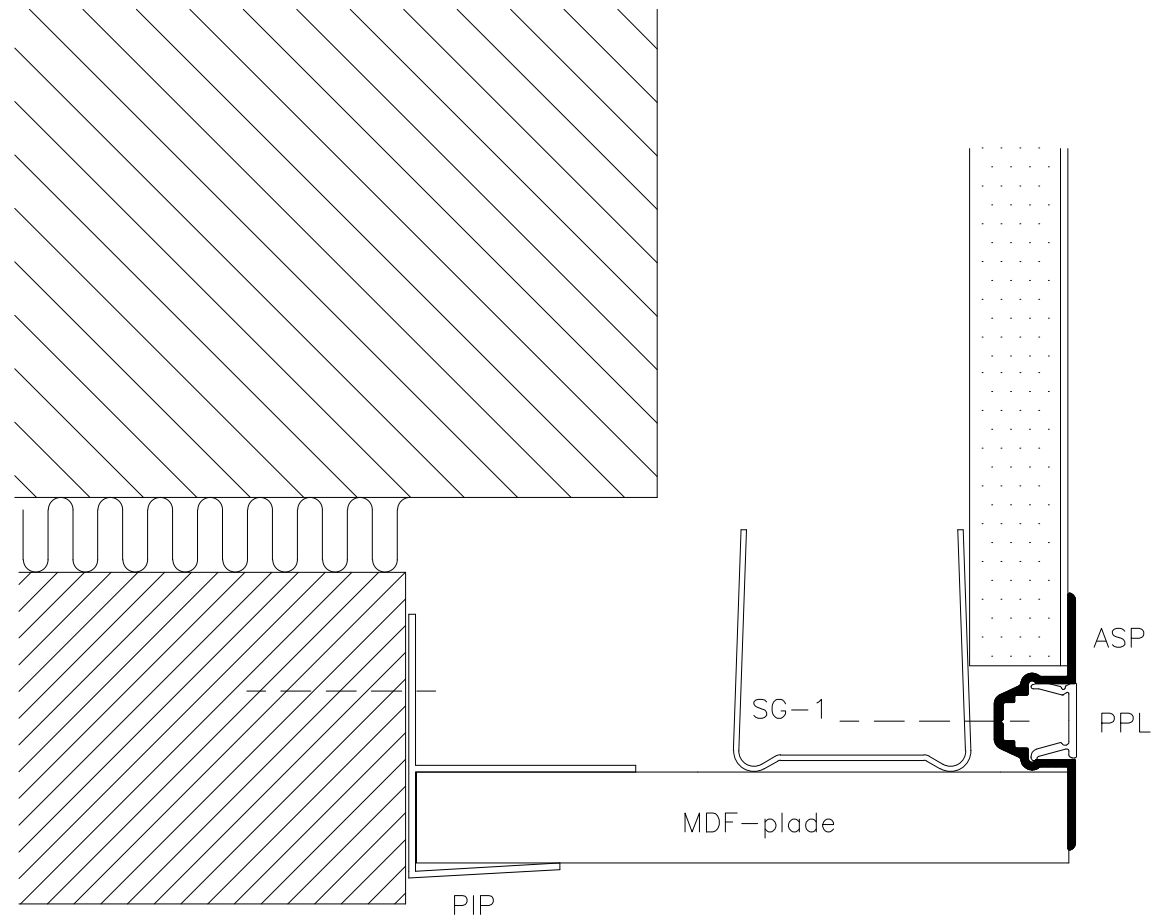

	<b>DEKO</b> <b>Tlf./Tel:</b> +45 43 55 77 11 <a href="http://www.deko.dk">www.deko.dk</a> / <a href="http://www.deko.com">www.deko.com</a>		<b>Projekt/Project:</b> DEKO PV 590	
	<b>Sags Nr./Case No.:</b>		<b>Dato/Date:</b>	<b>Tegn. Nr. Sheet No.</b> 1/1
	<b>Mål/Scale</b> 1:1		<b>Emne/Subject:</b> @g\c\hYfZj JbXi Yf YHW L2A	<b>Revideret/Revision:</b> 2016-05-02-V01

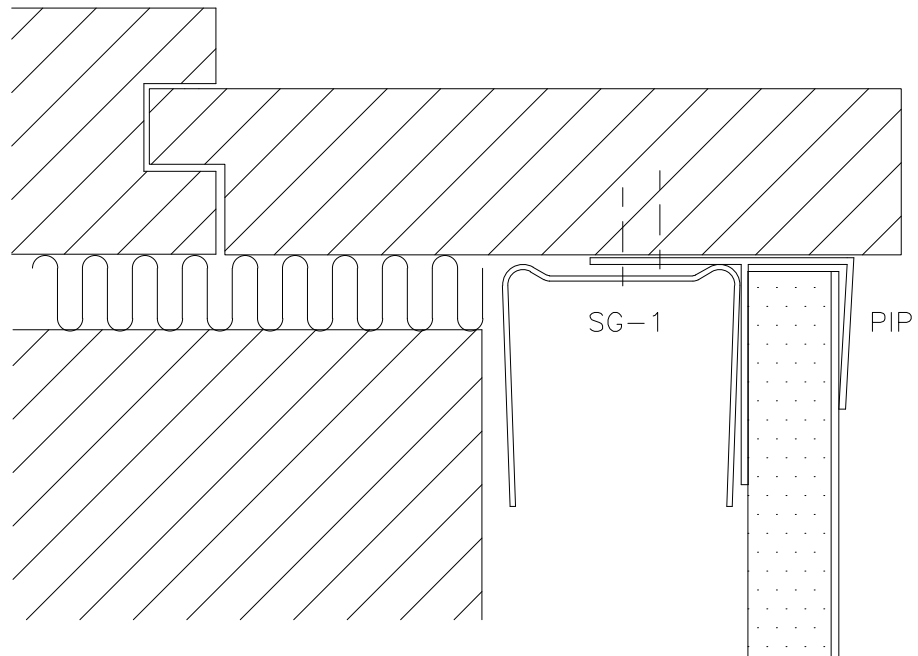

	<b>DEKO</b>	<b>Projekt/Project:</b>	
	<b>Tlf./Tel:</b> +45 43 55 77 11 www.deko.dk / www.deko.com	DEKO PV 590	
<b>Sags Nr./Case No.:</b>	<b>Emne/Subject:</b>	<b>Dato/Date:</b>	<b>Tegn. Nr. Sheet No.</b> 1/1
<b>Mål/Scale</b> 1:1	@ g\ c` hYfZj JbXi Yf` YHW L2B	<b>Revideret/Revision:</b> 2016-05-02-V01	<b>Signatur Signature</b> OP/EZ

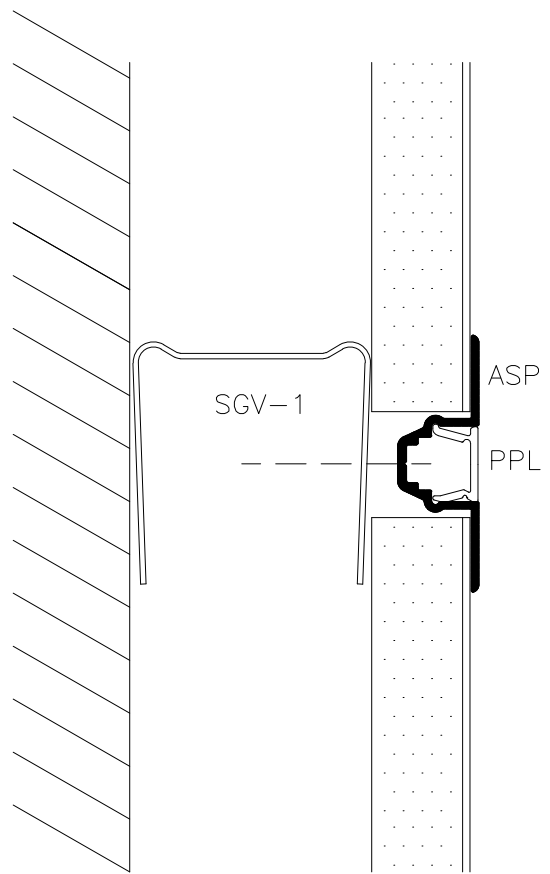

	<b>DEKO</b> Tlf./Tel: +45 43 55 77 11 www.deko.dk / www.deko.com	<b>Projekt/Project:</b> DEKO PV 590	
	<b>Sags Nr./Case No.:</b>	<b>Emne/Subject:</b> @g\c`hYfZj JbXi Yf`YHW L2C	<b>Dato/Date:</b>
<b>Mål/Scale</b> 1:1		<b>Revideret/Revision:</b> 2016-05-02-V01	<b>Signatur Signature</b> OP/EZ

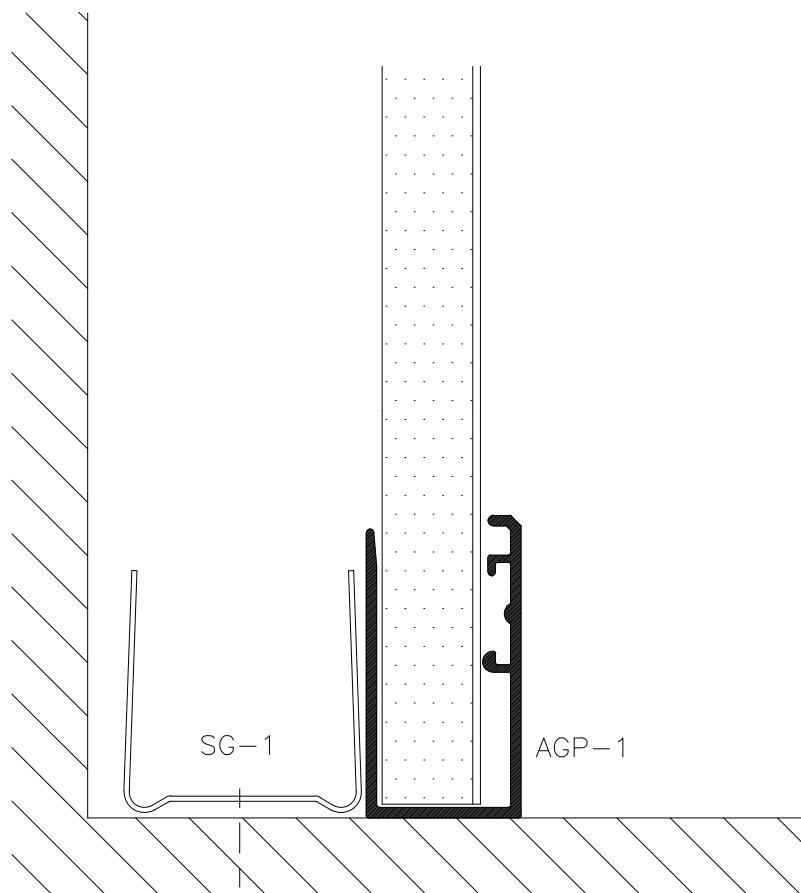

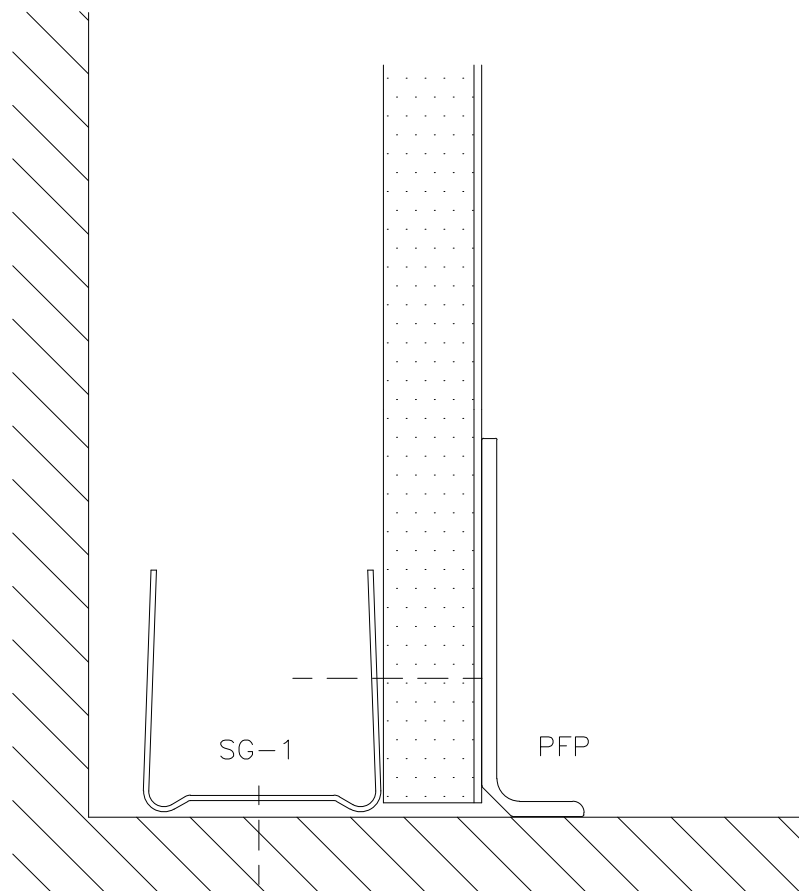

	<b>DEKO</b>	<b>Projekt/Project:</b>	
	<b>Tlf./Tel:</b> +45 43 55 77 11 www.deko.dk / www.deko.com	DEKO PV 590	
<b>Sags Nr./Case No.:</b>	<b>Emne/Subject:</b>	<b>Dato/Date:</b>	<b>Tegn. Nr. Sheet No.</b> 1/1
<b>Mål/Scale</b> 1:1	Gulvtilslutning L3A	<b>Revideret/Revision:</b> 2016-05-02-V01	<b>Signatur Signature</b> OP/EZ



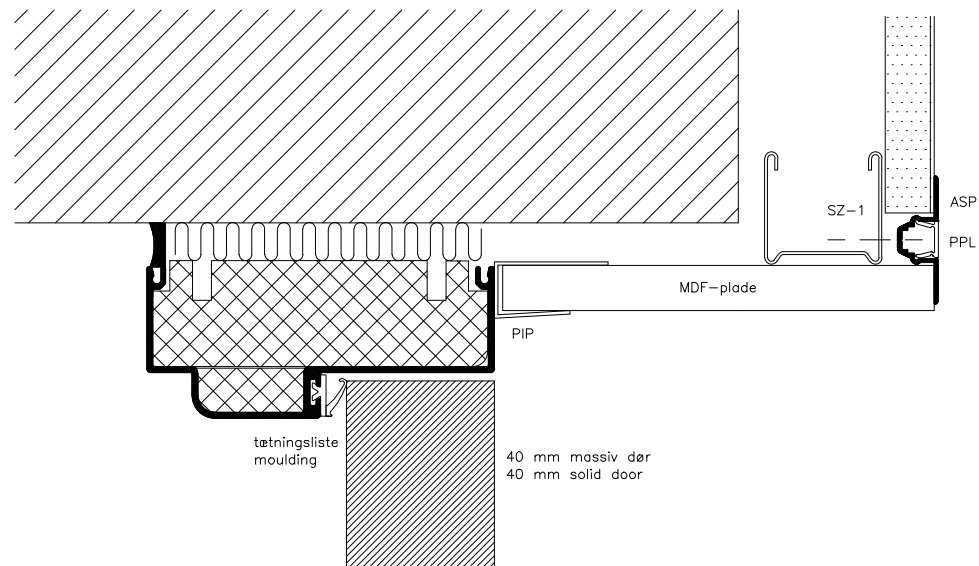

	<b>DEKO</b>	<b>Projekt/Project:</b>	
	<b>Tlf./Tel:</b> +45 43 55 77 11 www.deko.dk / www.deko.com	DEKO PV 590	
<b>Sags Nr./Case No.:</b>	<b>Emne/Subject:</b>	<b>Dato/Date:</b>	<b>Tegn. Nr. Sheet No.</b> 1/1
<b>Mål/Scale</b> 1:1	Gulvtilslutning L3B	<b>Revideret/Revision:</b> 2016-05-02-V01	<b>Signatur Signature</b> OP/EZ





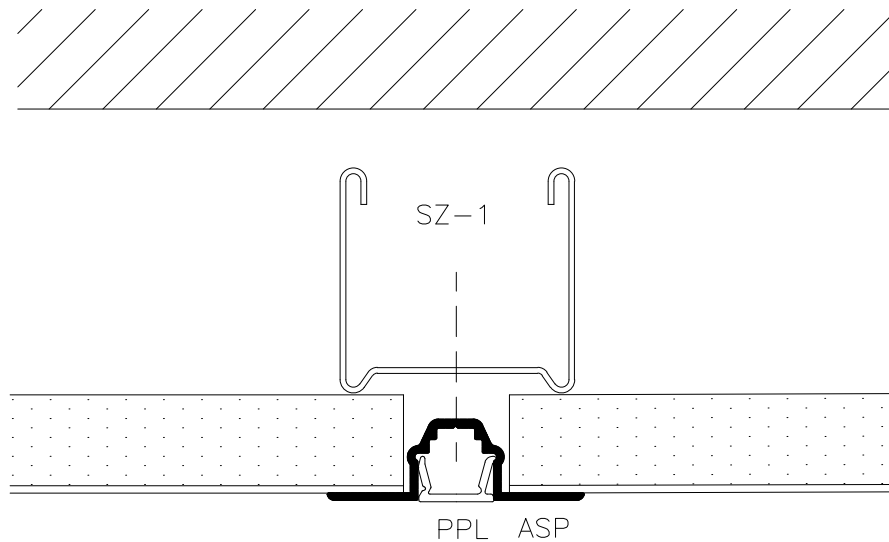

	<b>DEKO</b> Tlf./Tel: +45 43 55 77 11 www.deko.dk / www.deko.com	<b>Projekt/Project:</b> DEKO PV 590	
	<b>Sags Nr./Case No.:</b>	<b>Emne/Subject:</b> 8»f L4A	<b>Dato/Date:</b>
<b>Mål/Scale</b> 1:2		<b>Revideret/Revision:</b> 2016-05-02-V01	<b>Signatur Signature</b> OP/EZ

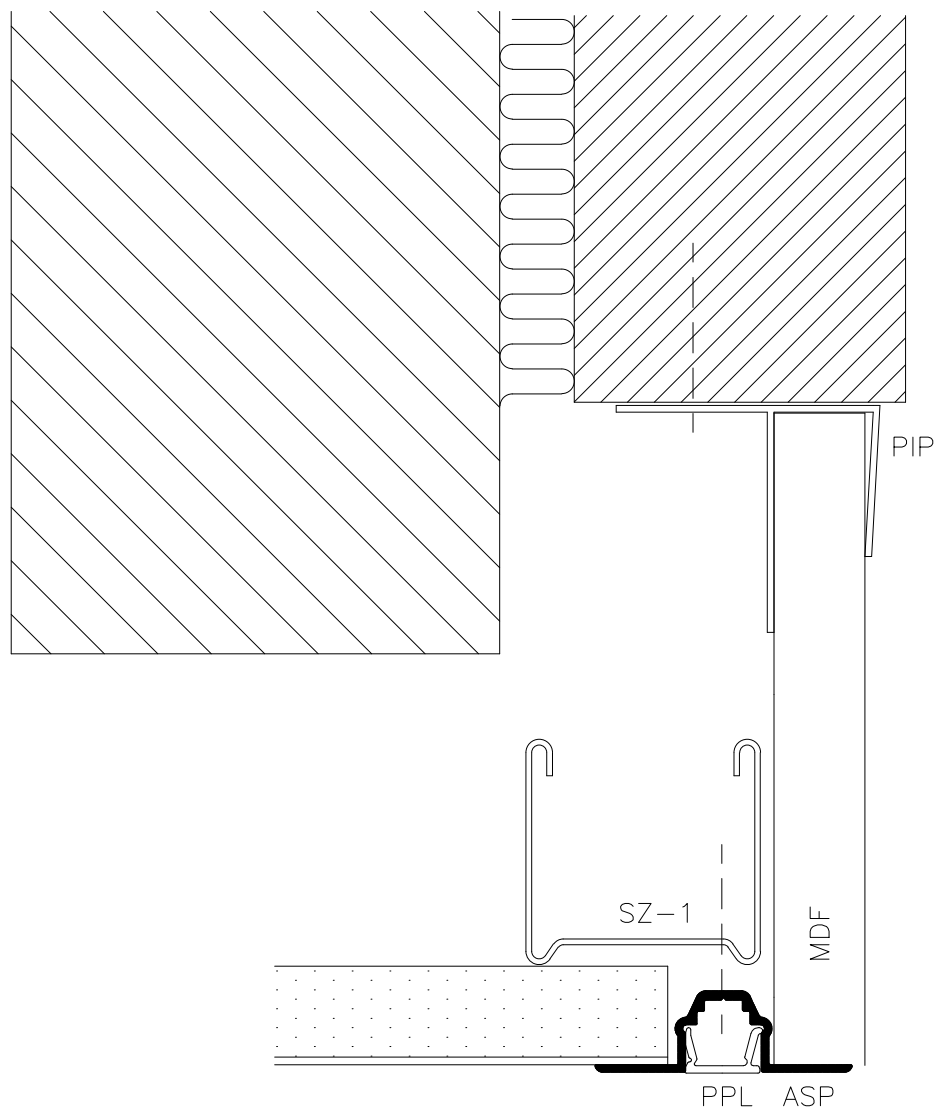

	<b>DEKO</b>	<b>Projekt/Project:</b>	
	<b>Tlf./Tel:</b> +45 43 55 77 11 www.deko.dk / www.deko.com	DEKO PV 590	
<b>Sags Nr./Case No.:</b>	<b>Emne/Subject:</b>	<b>Dato/Date:</b>	<b>Tegn. Nr. Sheet No.</b> 1/1
<b>Mål/Scale</b> 1:1	Stolpesamling V1A	<b>Revideret/Revision:</b> 2016-05-02-V01	<b>Signatur Signature</b> OP/EZ



	<b>DEKO</b> <b>Tlf./Tel:</b> +45 43 55 77 11 <a href="http://www.deko.dk">www.deko.dk</a> / <a href="http://www.deko.com">www.deko.com</a>	<b>Projekt/Project:</b> DEKO PV 590	
	<b>Sags Nr./Case No.:</b>	<b>Emne/Subject:</b> Stolpesamling V1B	<b>Dato/Date:</b>
<b>Mål/Scale</b> 1:1		<b>Revideret/Revision:</b> 2016-05-02-V01	<b>Signatur Signature</b> OP/EZ

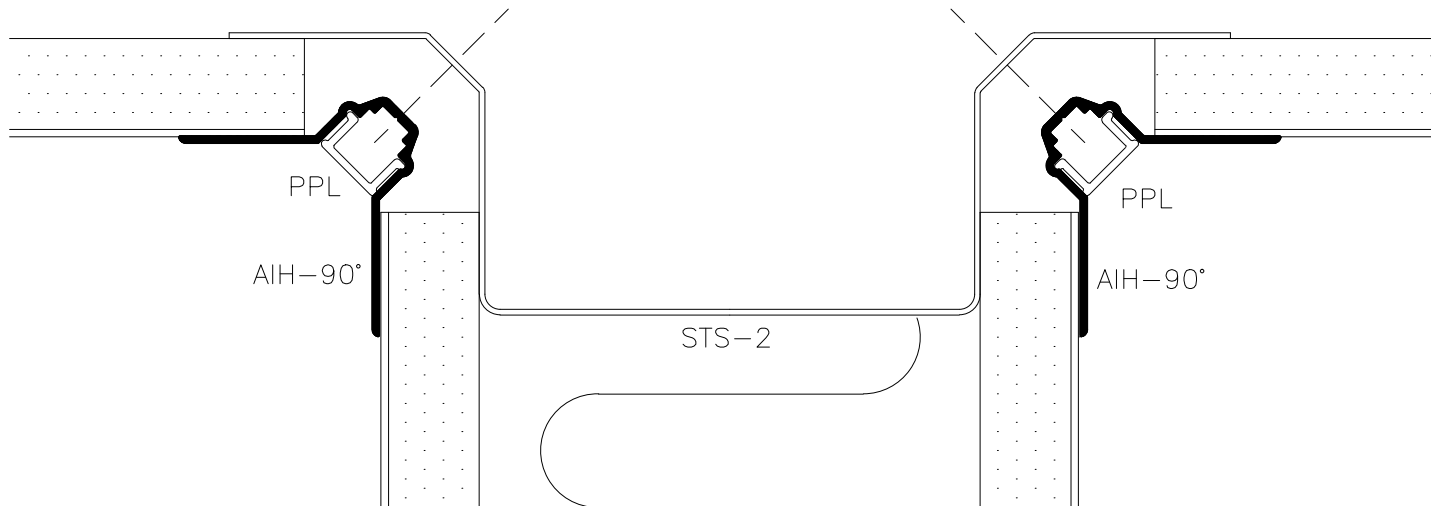
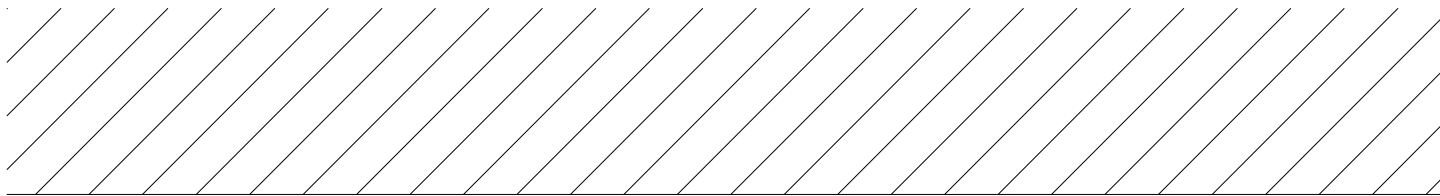

**DEKO**

**Tlf./Tel:** +45 43 55 77 11  
www.deko.dk / www.deko.com

**Projekt/Project:**

DEKO PV 590

**Sags Nr./Case No.:**

**Emne/Subject:**

T-samling

V2A

**Dato/Date:**

**Tegn. Nr.**

**Sheet No.** 1/1

**Mål/Scale**

1:1

**Revideret/Revision:**

2016-05-02-V01

**Signatur**

**Signature** OP/EZ

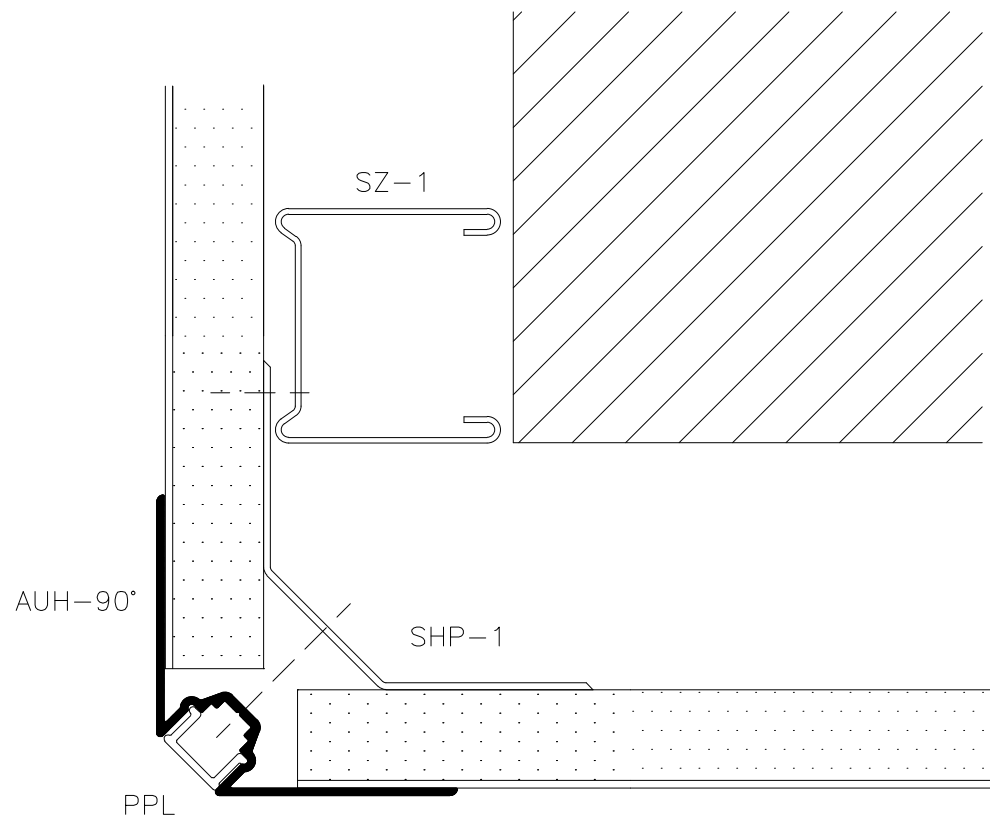

**DEKO**  
**Tlf./Tel:** +45 43 55 77 11  
[www.deko.dk](http://www.deko.dk) / [www.deko.com](http://www.deko.com)

**Projekt/Project:**  
DEKO PV 590

**Sags Nr./Case No.:**

**Emne/Subject:**  
- Ss \ \ fbY  
V3A

**Dato/Date:**

**Tegn. Nr. Sheet No.** 1/1

**Mål/Scale**  
1:1

**Revideret/Revision:**

2016-05-02-V01

**Signatur Signature** OP/EZ

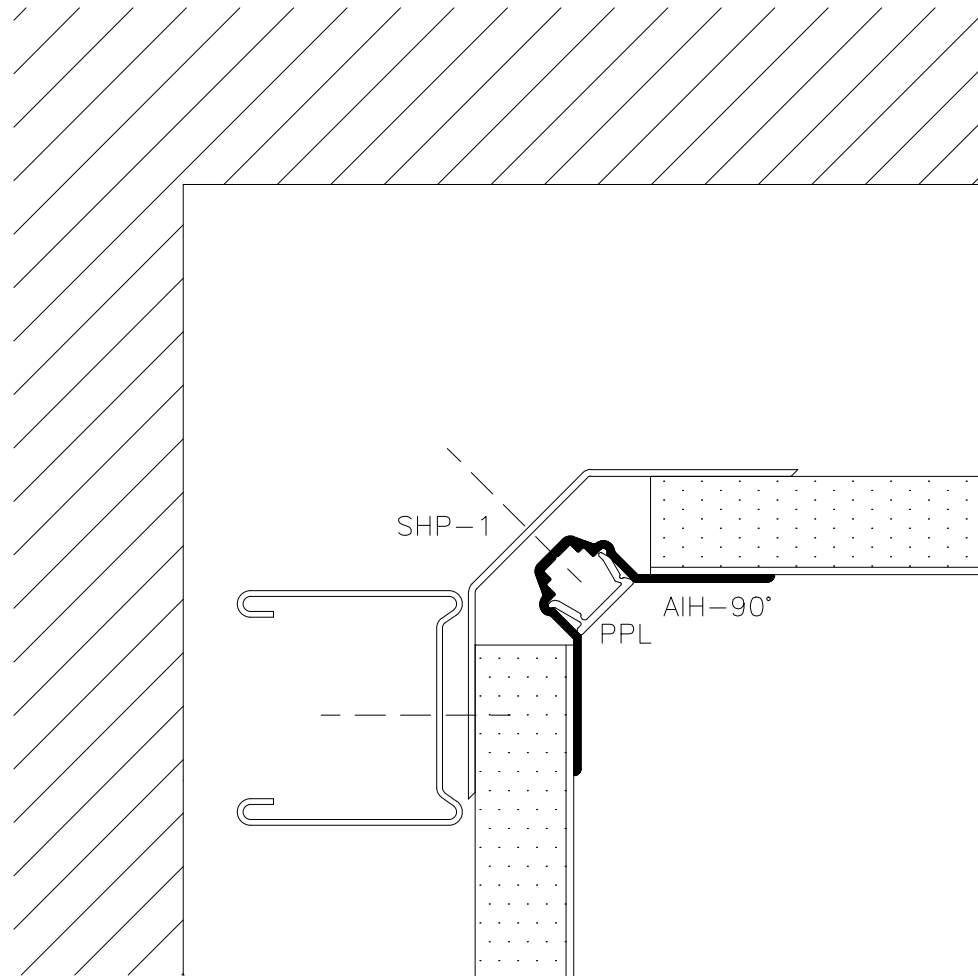

	<b>DEKO</b>	<b>Projekt/Project:</b>	
	<b>Tlf./Tel:</b> +45 43 55 77 11 www.deko.dk / www.deko.com	DEKO PV 590	
<b>Sags Nr./Case No.:</b>	<b>Emne/Subject:</b>	<b>Dato/Date:</b>	<b>Tegn. Nr. Sheet No.</b> 1/1
<b>Mål/Scale</b> 1:1	- Ss \ \ fbY V3B	<b>Revideret/Revision:</b> 2016-05-02-V01	<b>Signatur Signature</b> OP/EZ

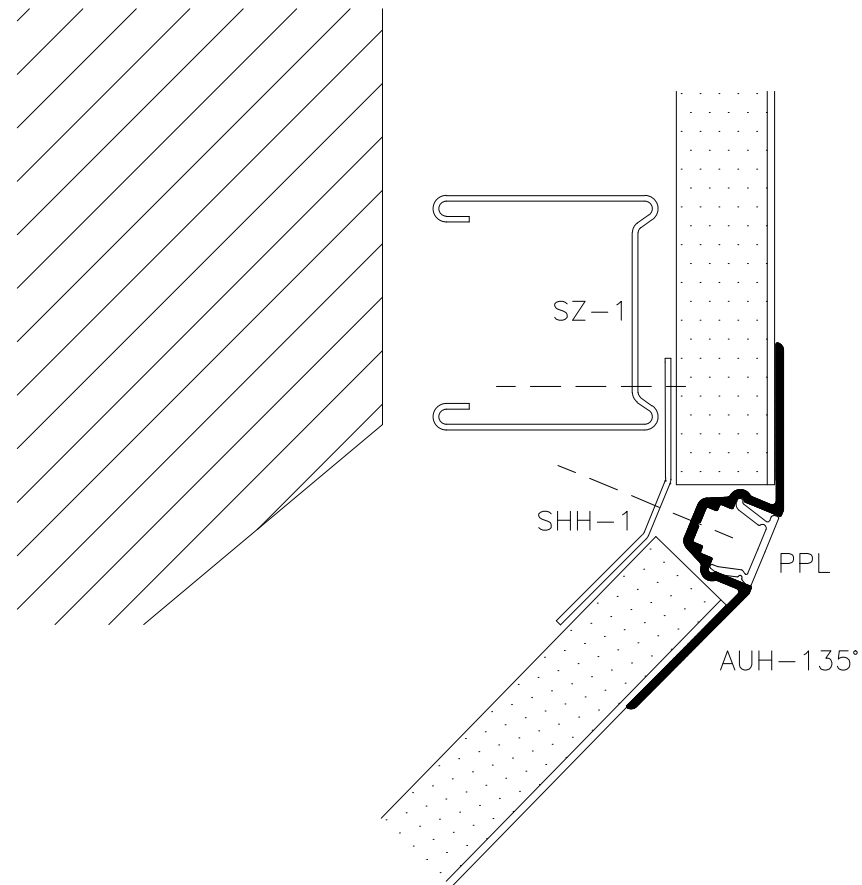

	<b>DEKO</b> <b>Tlf./Tel:</b> +45 43 55 77 11 <a href="http://www.deko.dk">www.deko.dk</a> / <a href="http://www.deko.com">www.deko.com</a>	<b>Projekt/Project:</b> DEKO PV 590	
	<b>Sags Nr./Case No.:</b>	<b>Emne/Subject:</b> % ) š` \ ¨ fbY V4A	<b>Dato/Date:</b>
<b>Mål/Scale</b> 1:1		<b>Revideret/Revision:</b> 2016-05-02-V01	<b>Signatur Signature</b> OP/EZ

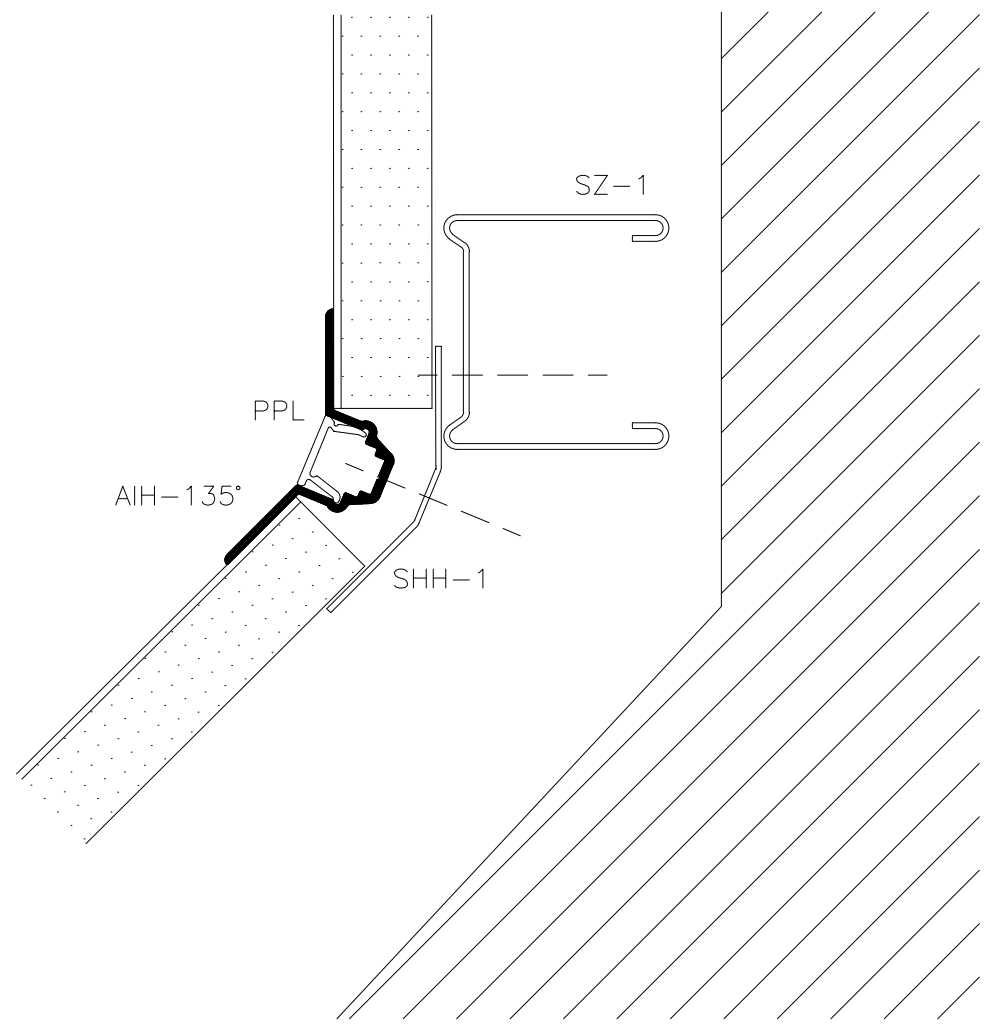

**DEKO**  
**Tlf./Tel:** +45 43 55 77 11  
www.deko.dk / www.deko.com

**Projekt/Project:**  
DEKO PV 590

**Sags Nr./Case No.:**

**Emne/Subject:**  
% ) š ` \ } fbY

**Dato/Date:**

**Tegn. Nr. Sheet No.** 1/1

**Mål/Scale**  
1:1

**V4B**

**Revideret/Revision:**  
2016-05-02-V01

**Signatur Signature** OP/EZ



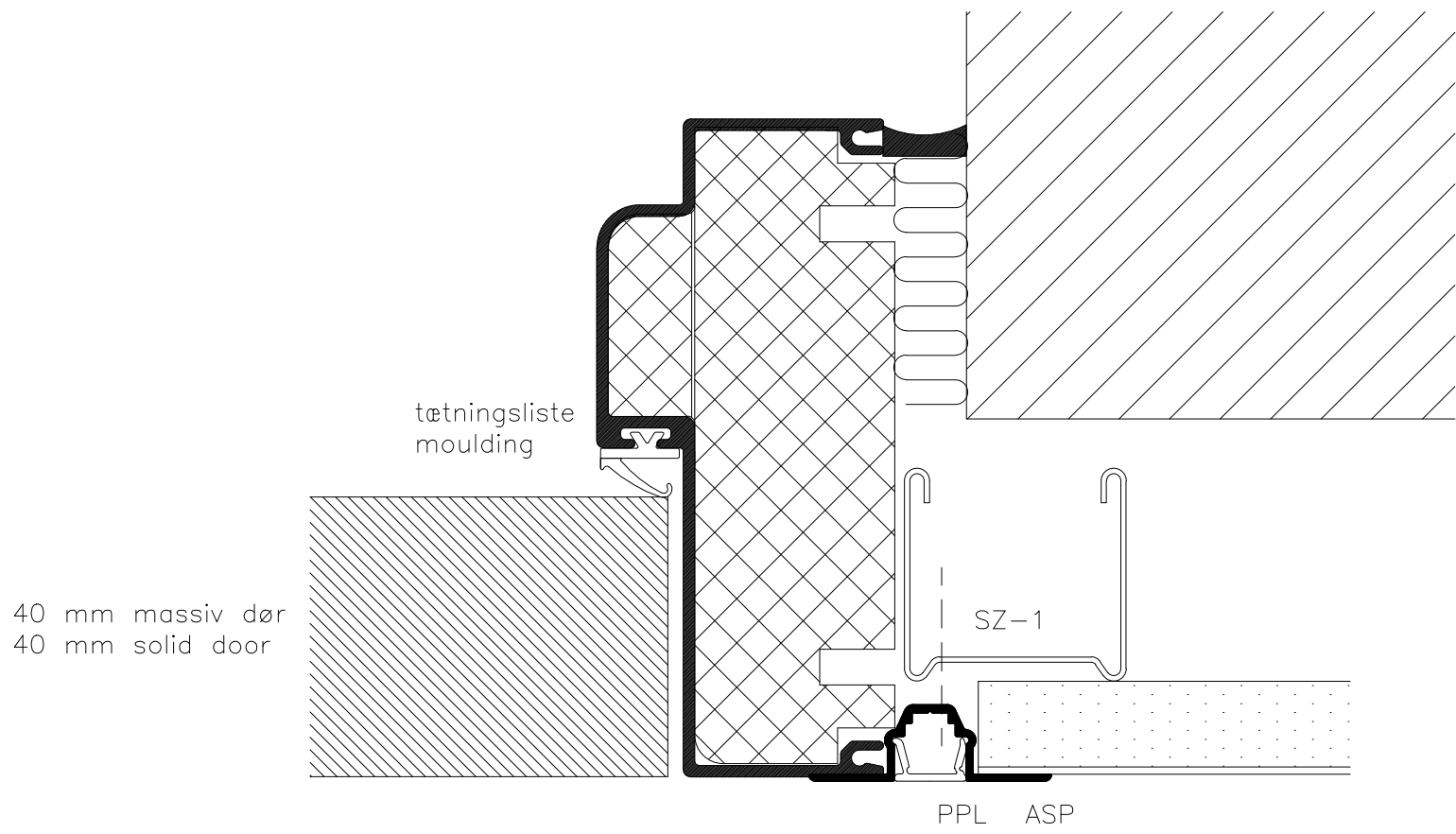

	<b>DEKO</b> <b>Tlf./Tel:</b> +45 43 55 77 11 <a href="http://www.deko.dk">www.deko.dk</a> / <a href="http://www.deko.com">www.deko.com</a>		<b>Projekt/Project:</b> DEKO PV 590	
	<b>Sags Nr./Case No.:</b>	<b>Emne/Subject:</b> 8»fh}g'i lb}b[ V5A		<b>Dato/Date:</b>
<b>Mål/Scale</b> 1:1			<b>Revideret/Revision:</b> 2016-05-02-V01	<b>Signatur Signature</b> OP/EZ

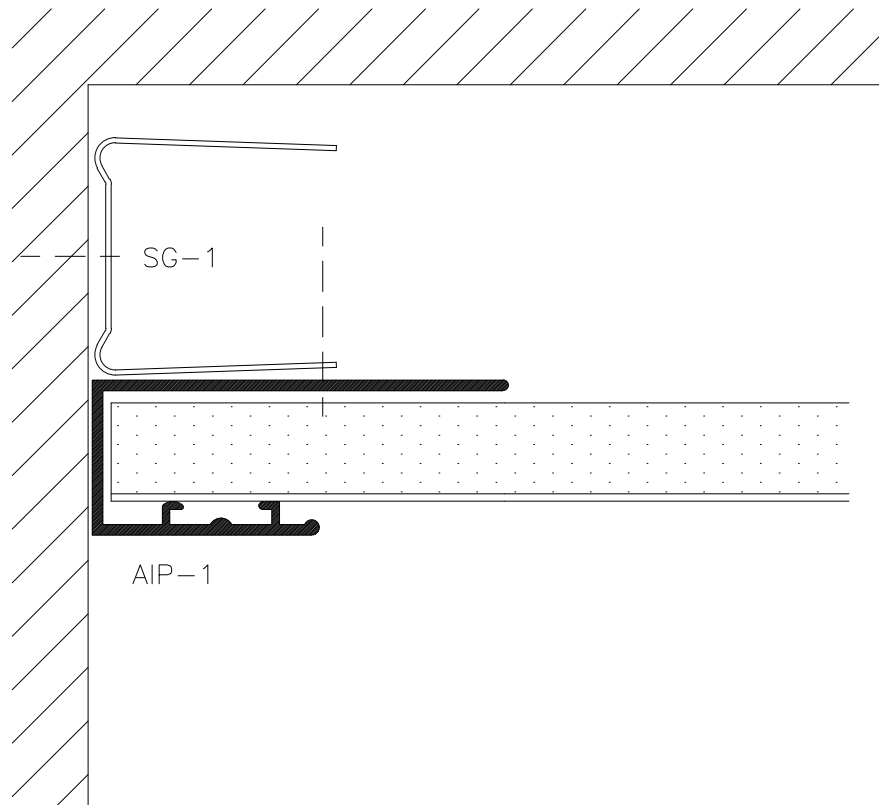

**DEKO**

**Tlf./Tel:** +45 43 55 77 11  
[www.deko.dk](http://www.deko.dk) / [www.deko.com](http://www.deko.com)

**Projekt/Project:**

DEKO PV 590

**Sags Nr./Case No.:**

**Emne/Subject:**

J° [h]g[i h]b[

V7A

**Dato/Date:**

**Tegn. Nr.**

**Sheet No.** 1/1

**Mål/Scale**

1:1

**Revideret/Revision:**

2016-05-02-V01

**Signatur**

**Signature** OP/EZ

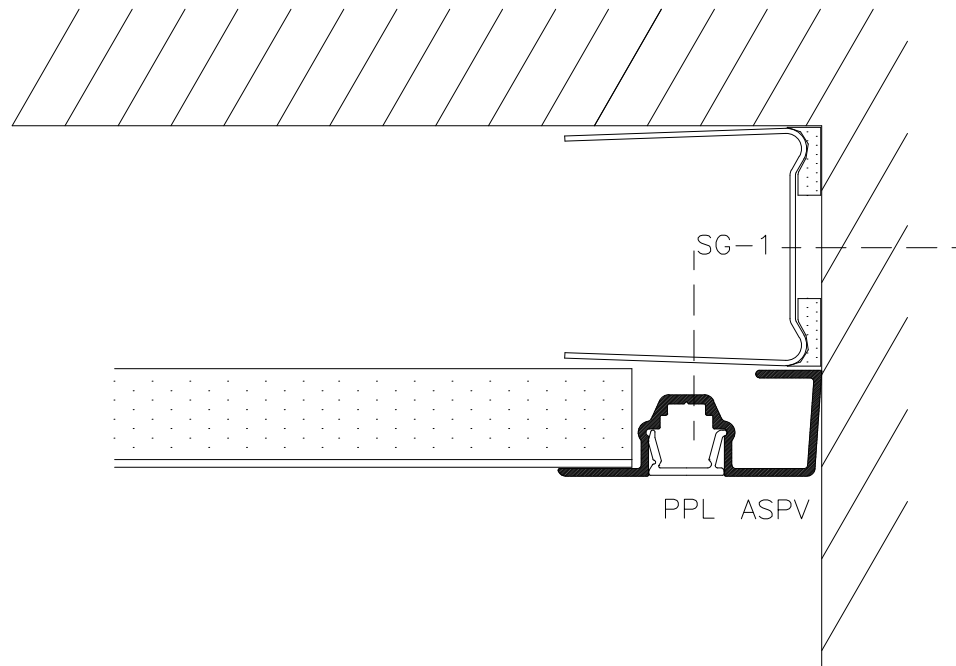

	<b>DEKO</b>	<b>Projekt/Project:</b>	
	<b>Tlf./Tel:</b> +45 43 55 77 11 www.deko.dk / www.deko.com	DEKO PV 590	
<b>Sags Nr./Case No.:</b>	<b>Emne/Subject:</b>	<b>Dato/Date:</b>	<b>Tegn. Nr. Sheet No.</b> 1/1
<b>Mål/Scale</b> 1:1	J° [h]g[i h]b[ V7B	<b>Revideret/Revision:</b> 2016-05-02-V01	<b>Signatur</b> OP/EZ