

	DEKO Tlf./Tel: +45 43 55 77 11 www.deko.dk / www.deko.com	Projekt/Project: DEKO	
	Sags Nr./Case No.: 2017-05-30-1400	Emne/Subject: DEKO MV Åben Topskinne Vægopstalt	Dato/Date: 2017-05-30
Mål/Scale: 1:1		Revideret/Revision: 2017-06-02-V01	Signatur Signature

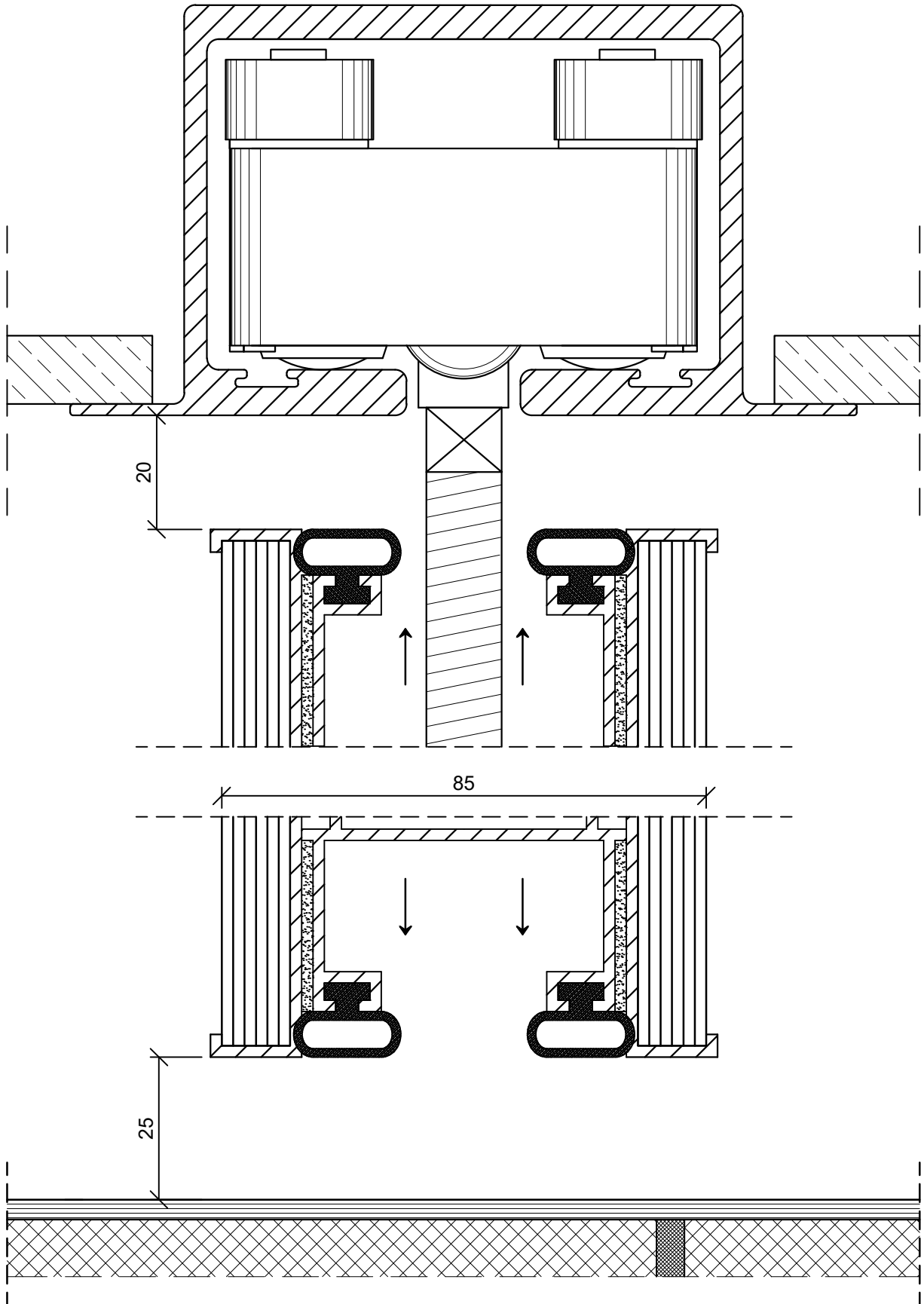

	DEKO Tlf./Tel: +45 43 55 77 11 www.deko.dk / www.deko.com	Projekt/Project: DEKO	
	Sags Nr./Case No.: 2017-05-30-1400	Emne/Subject: DEKO MV Åben Topskinn Vægopstalt Vinger	Dato/Date: 2017-05-30
Mål/Scale: 1:1		Revideret/Revision: 2017-06-02-V01	Signatur Signature

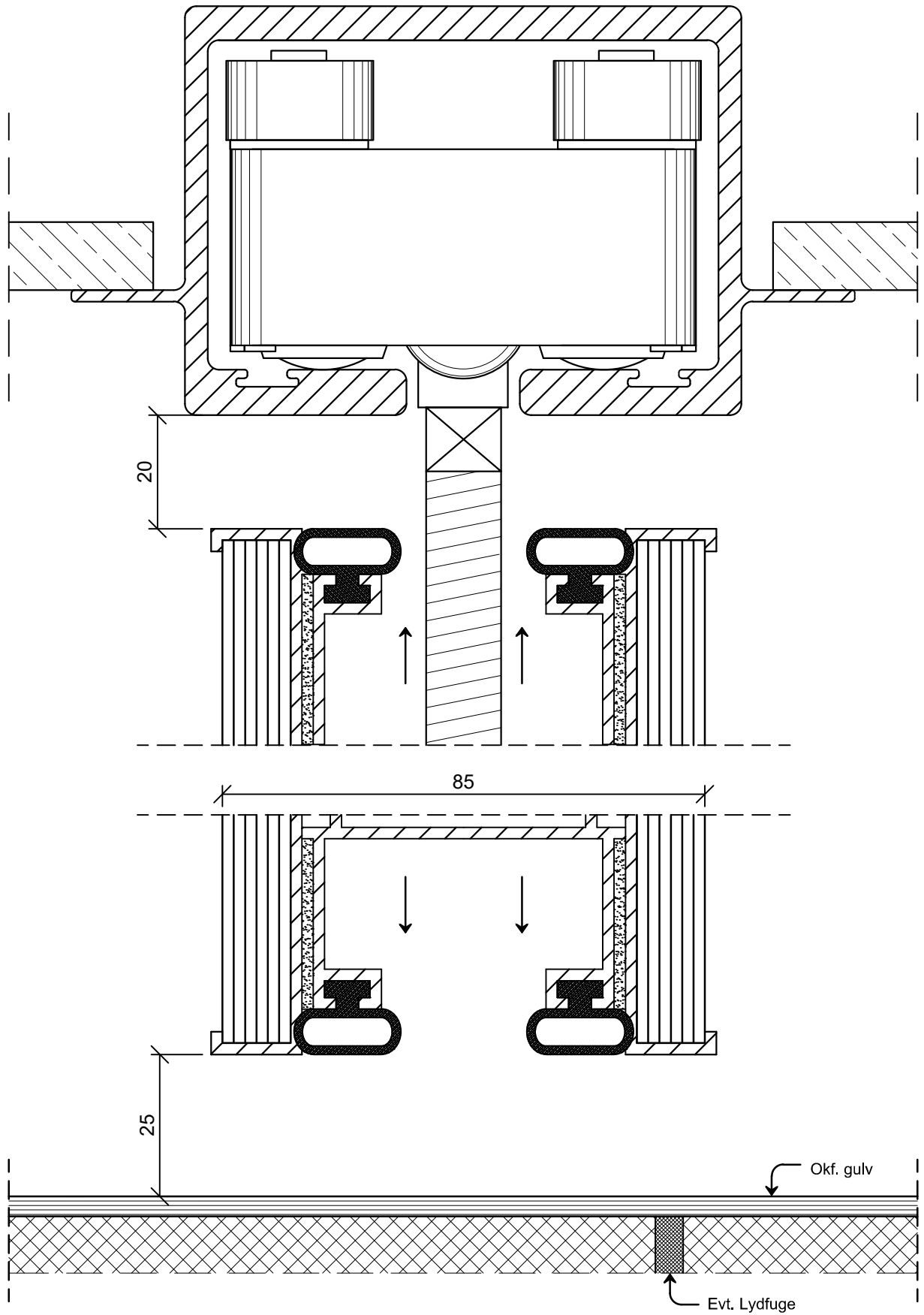

	DEKO Tlf./Tel: +45 43 55 77 11 www.deko.dk / www.deko.com		Projekt/Project: DEKO	
	Sags Nr./Case No.: 2017-05-30-1400		Dato/Date: 2017-05-30	
Mål/Scale: 1:1		Emne/Subject: DEKO MV Åben Topskinne Vægopstalt Vinger		Tegn. Nr. Sheet No. 1/1
		Revideret/Revision: 2017-06-05-V01		Signatur Signature

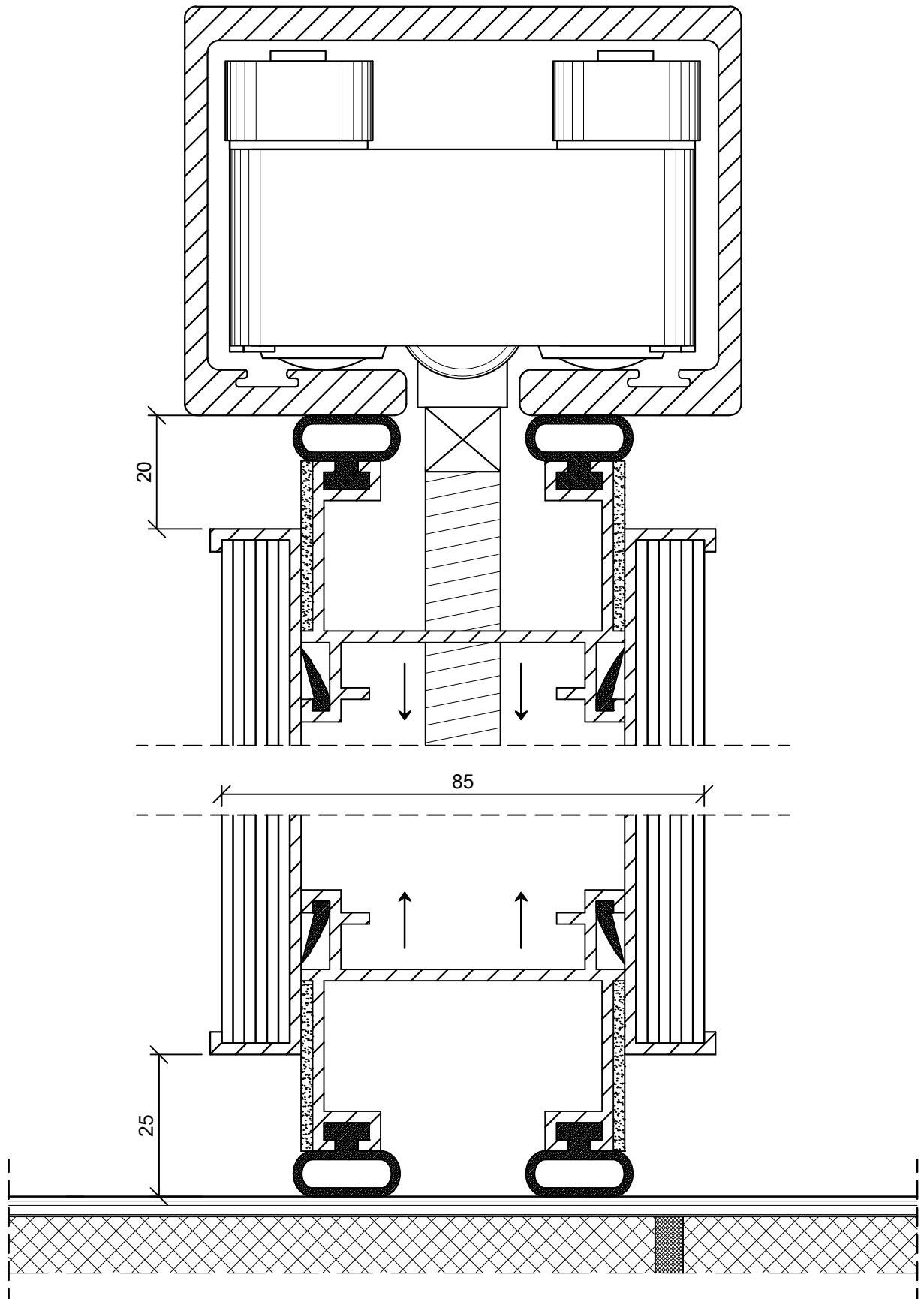

	DEKO Tlf./Tel: +45 43 55 77 11 www.deko.dk / www.deko.com	Projekt/Project: DEKO	
	Sags Nr./Case No.: 2017-05-30-1400	Emne/Subject: DEKO MV ben Topskinne Vgopstalt	Dato/Date: 2017-05-30
Ml/Scale: 1:1		Revideret/Revision: 2017-06-05-V01	Signatur Signature

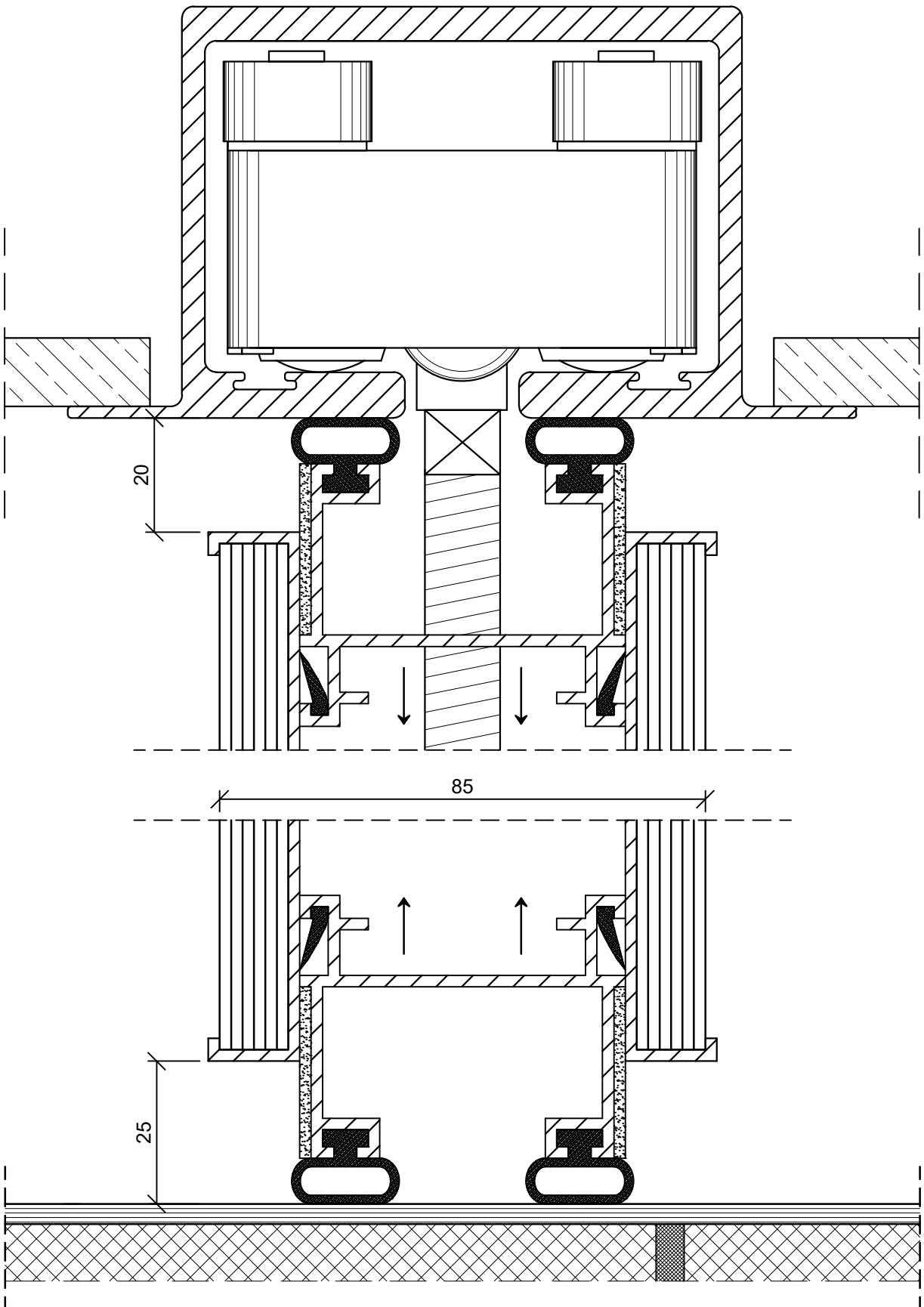

	DEKO Tlf./Tel: +45 43 55 77 11 www.deko.dk / www.deko.com	Projekt/Project: DEKO	
	Sags Nr./Case No.: 2017-05-30-1400	Emne/Subject: DEKO MV �ben Topskinne Vægopstalt Vinger	Dato/Date: 2017-05-30
M�l/Scale: 1:1		Revideret/Revision: 2017-06-05-V01	Signatur Signature

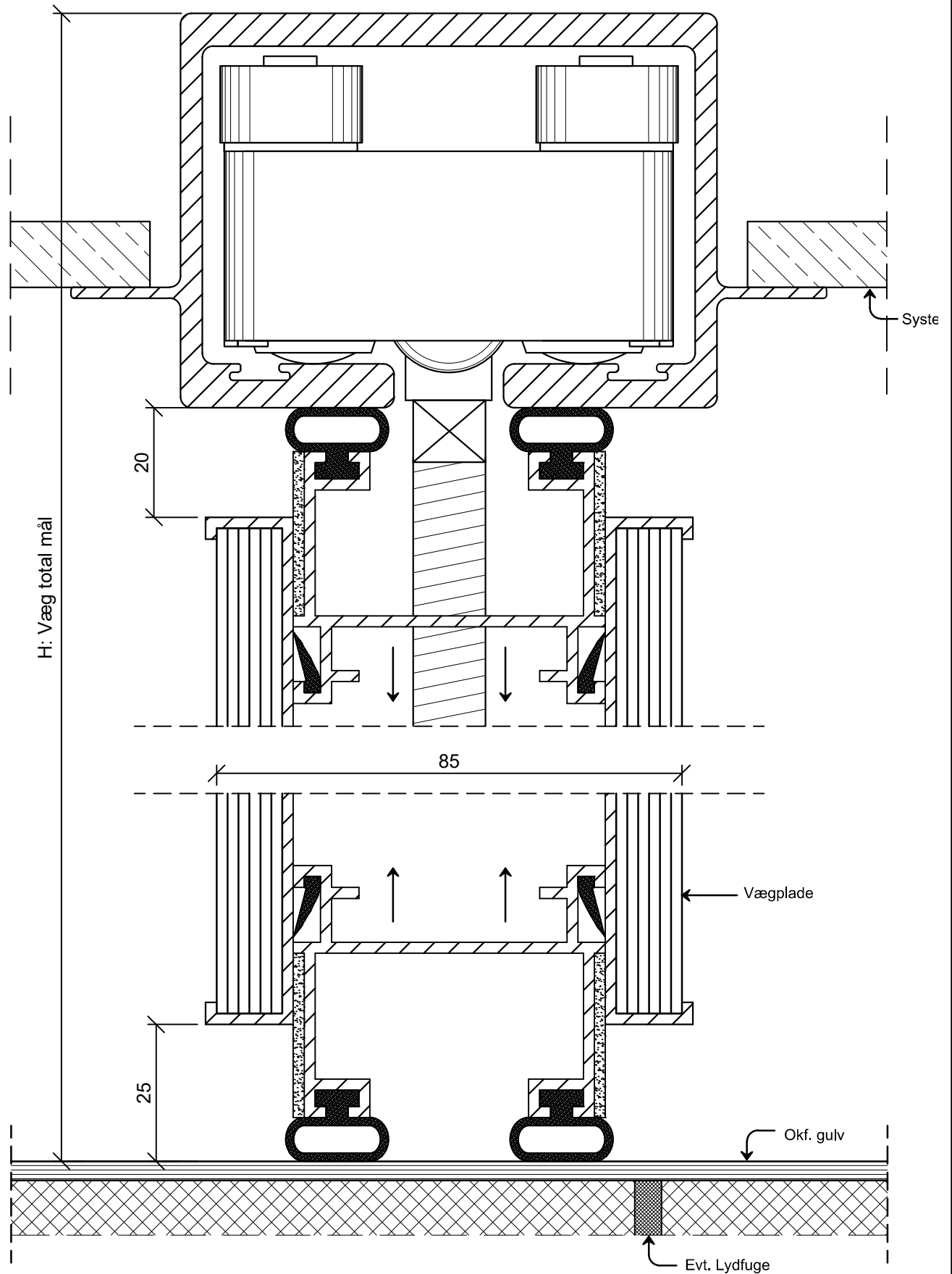

	DEKO Tlf./Tel: +45 43 55 77 11 www.deko.dk / www.deko.com	Projekt/Project: DEKO	
	Sags Nr./Case No.: 2017-05-30-1400	Emne/Subject: DEKO MV Åben Topskinne Vægopstalt Vinger	Dato/Date: 2017-05-30
Mål/Scale: 1:1		Revideret/Revision: 2017-06-05-V01	Signatur Signature

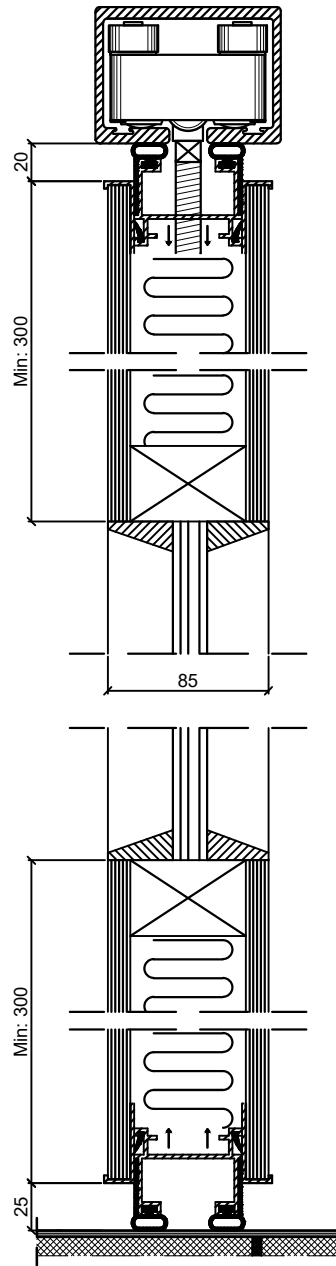

DEKO

Tlf./Tel: +45 43 55 77 11
 www.deko.dk / www.deko.com

Projekt/Project:

DEKO

Sags Nr./Case No.:
 2017-05-30-1400

Emne/Subject:

DEKO MV
 Lodret Snit i Glasmobilvæg

Dato/Date:
 2017-05-30

Tegn. Nr. / Sheet No. 1/1

Mål/Scale: 1:4

Revideret/Revision:
 2017-06-05-V01

Signatur / Signature

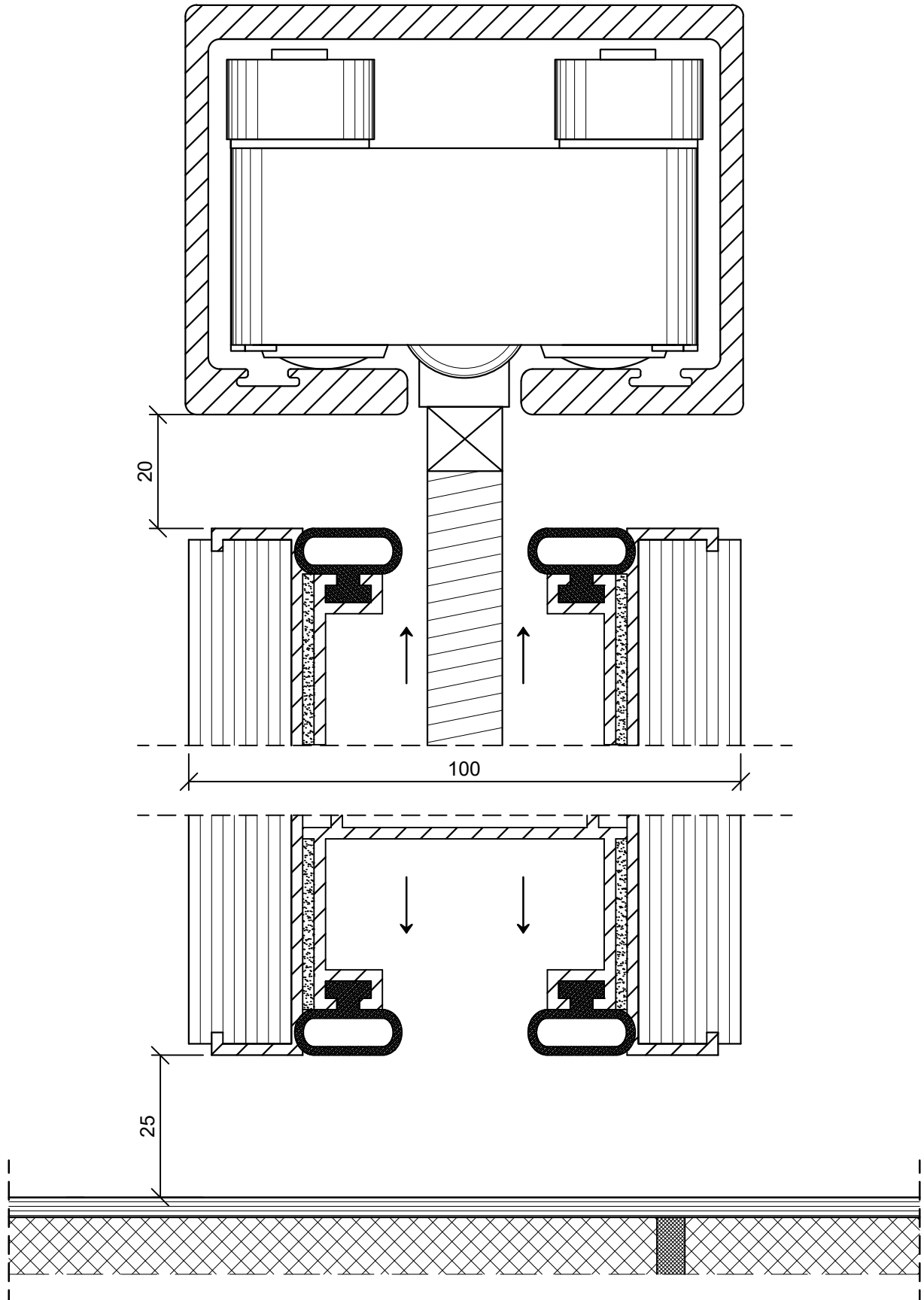

	DEKO Tlf./Tel: +45 43 55 77 11 www.deko.dk / www.deko.com	Projekt/Project: DEKO	
	Sags Nr./Case No.: 2017-05-30-1400	Emne/Subject: DEKO MV Åben Topskinne Vægopstalt	Dato/Date: 2017-05-30
Mål/Scale: 1:1		Revideret/Revision: 2017-06-05-V01	Signatur Signature

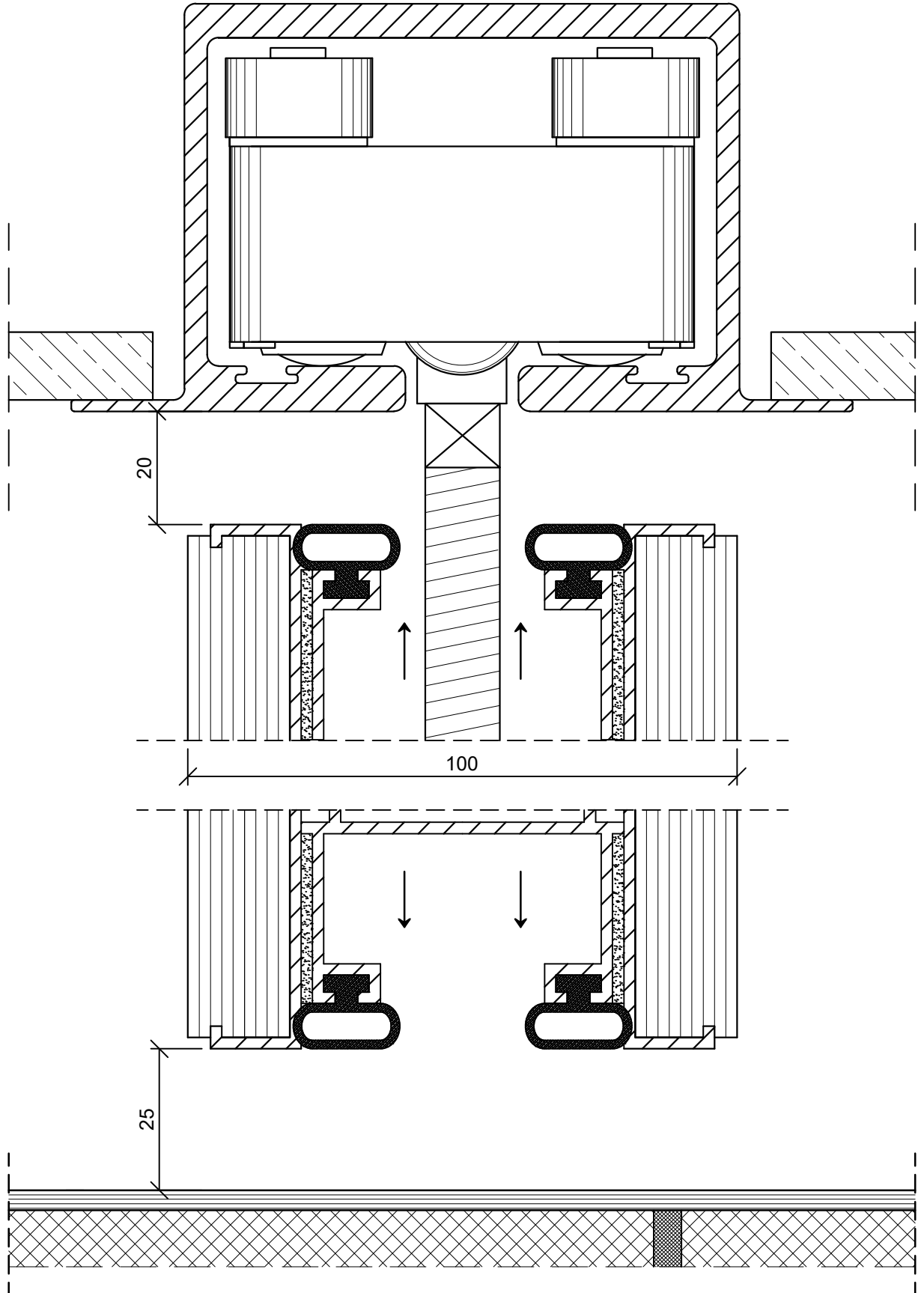

	DEKO Tlf./Tel: +45 43 55 77 11 www.deko.dk / www.deko.com	Projekt/Project: DEKO	
	Sags Nr./Case No.: 2017-05-30-1400	Emne/Subject: DEKO MV Åben Topskinne Vægopstalt Vinger	Dato/Date: 2017-05-30
Mål/Scale: 1:1		Revideret/Revision: 2017-06-05-V01	Signatur Signature

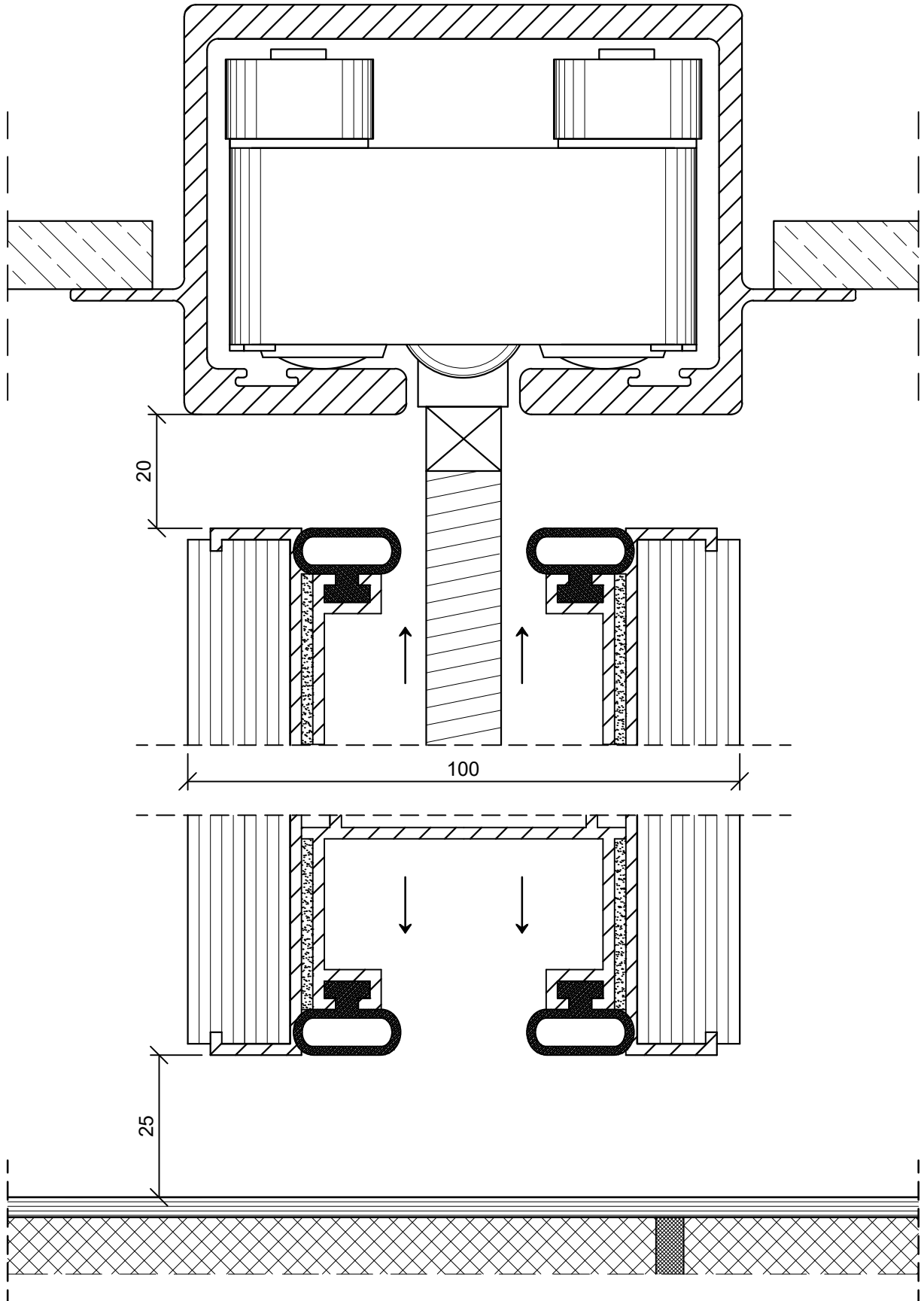

	DEKO Tlf./Tel: +45 43 55 77 11 www.deko.dk / www.deko.com	Projekt/Project: DEKO	
	Sags Nr./Case No.: 2017-05-30-1400	Emne/Subject: DEKO MV Åben Topskinne Vægopstalt Vinger	Dato/Date: 2017-05-30
Mål/Scale: 1:1		Revideret/Revision: 2017-06-05-V01	Signatur Signature

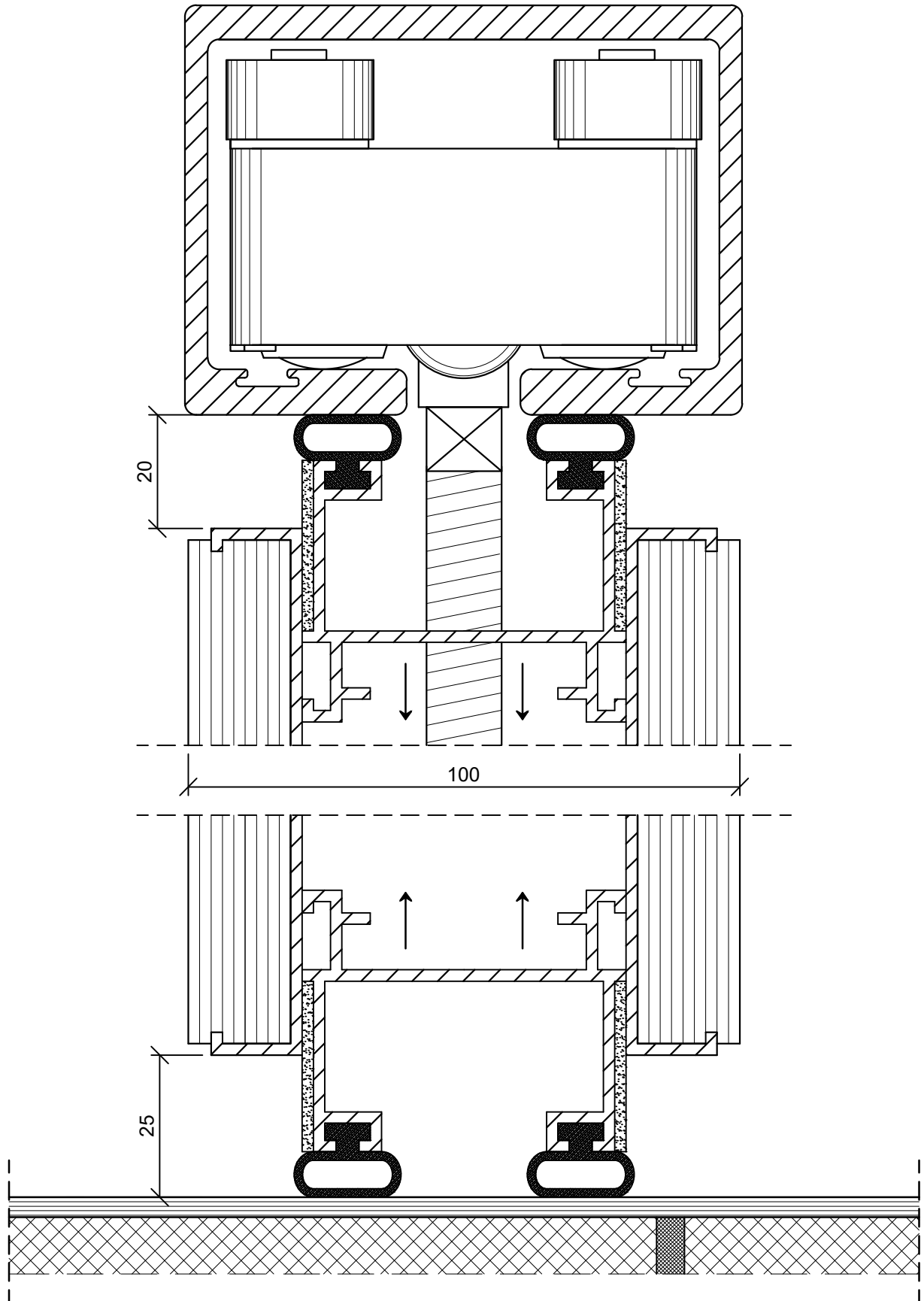

	DEKO Tlf./Tel: +45 43 55 77 11 www.deko.dk / www.deko.com	Projekt/Project: DEKO	
	Sags Nr./Case No.: 2017-05-30-1400	Emne/Subject: DEKO MV Fastlåst Topskinne Vægopstalt	Dato/Date: 2017-05-30
Mål/Scale: 1:1		Revideret/Revision: 2017-06-05-V01	Signatur Signature

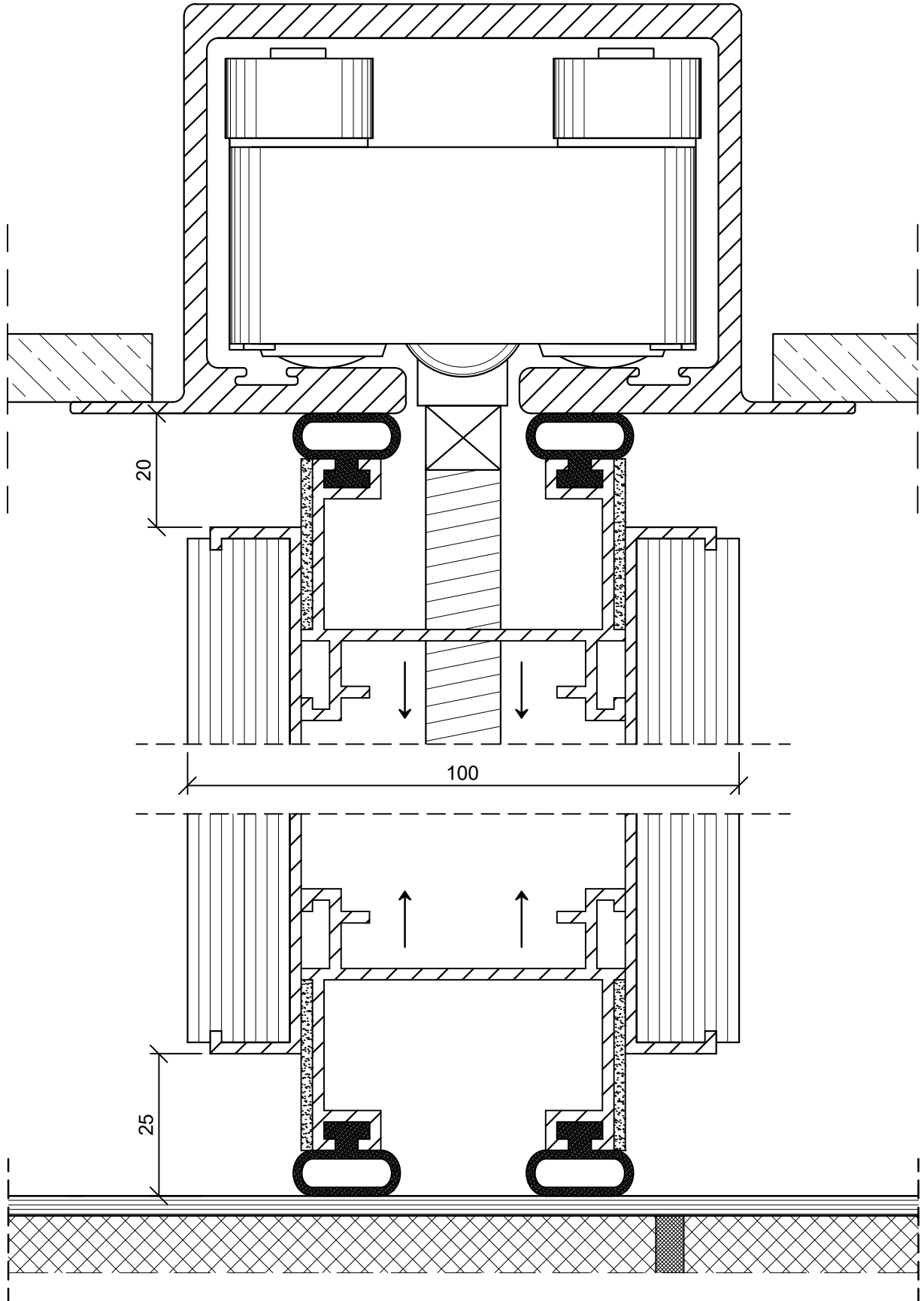

	DEKO Tlf./Tel: +45 43 55 77 11 www.deko.dk / www.deko.com	Projekt/Project: DEKO	
	Sags Nr./Case No.: 2017-05-30-1400	Emne/Subject: DEKO MV Fastlåst Topskinne Vægopstalt Vinger	Dato/Date: 2017-05-30
Mål/Scale: 1:1		Revideret/Revision: 2017-06-05-V01	Signatur Signature