

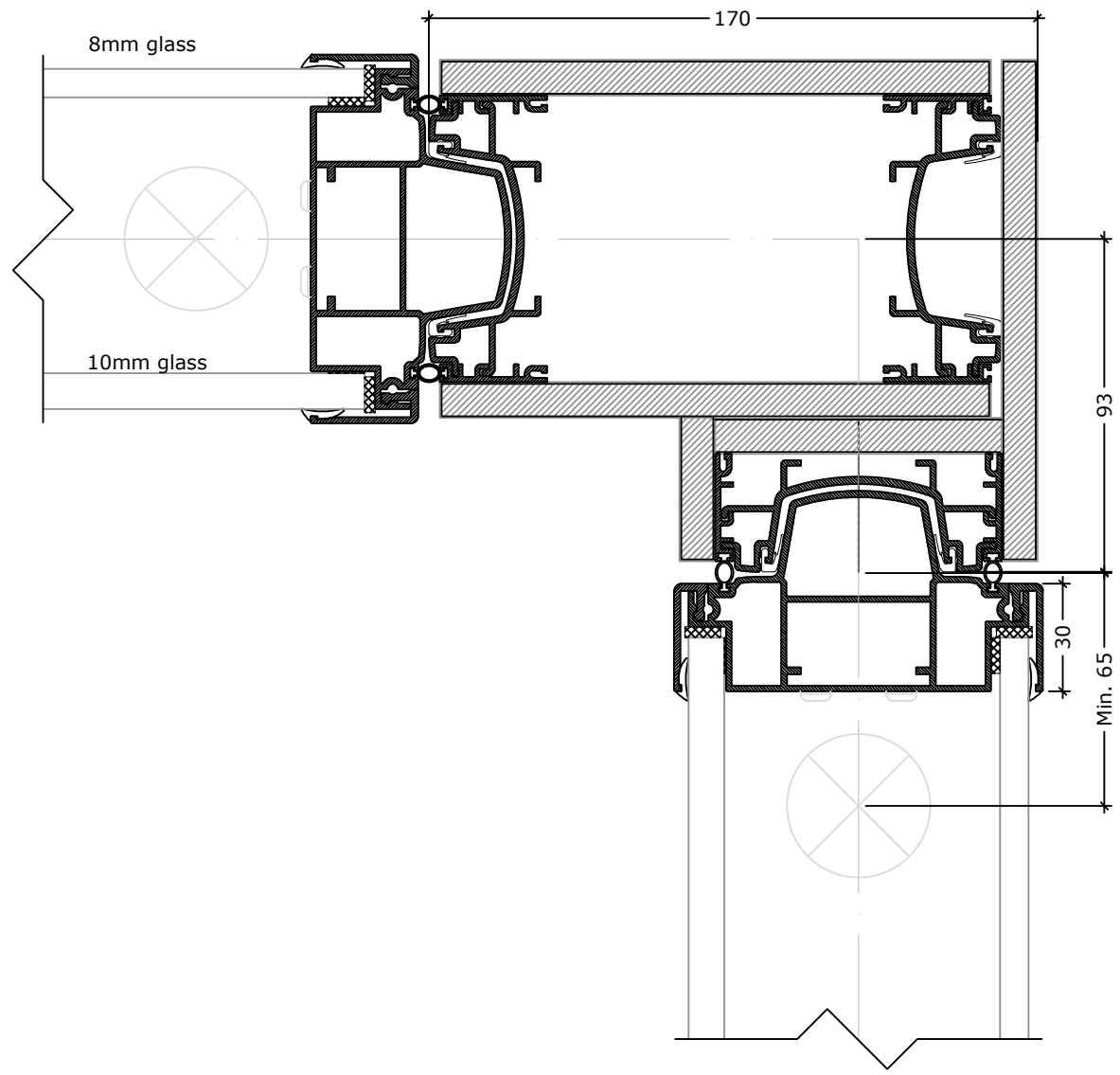

NOTE: Optional glass for 50dB is available.

	DEKO Tlf./Tel: +45 43 55 77 11 www.deko.dk / www.deko.com		Projekt/Project: DEKO	
	Sags Nr./Case No.:	Emne/Subject: DEKO MV2 Glass 50 - Dorma Moveo MV2 Glass_V1A	Dato/Date: 2017-05-31	Tegn. Nr. Sheet No. 1/1
Mål/Scale: 1:2		Revideret/Revision: 2017-06-01-V01	Signatur Signature XX	



NOTE: Optional glass for 50dB is available.

	DEKO Tlf./Tel: +45 43 55 77 11 www.deko.dk / www.deko.com	Projekt/Project: DEKO Glass element 90° corner	
	Sags Nr./Case No.:	Emne/Subject: DEKO MV2 Glass 44 - Dorma Moveo MV2 Glass_V1B	Dato/Date: 2017-05-31
Mål/Scale: 1:2		Revideret/Revision: 2017-06-01-V01	Signatur Signature XX

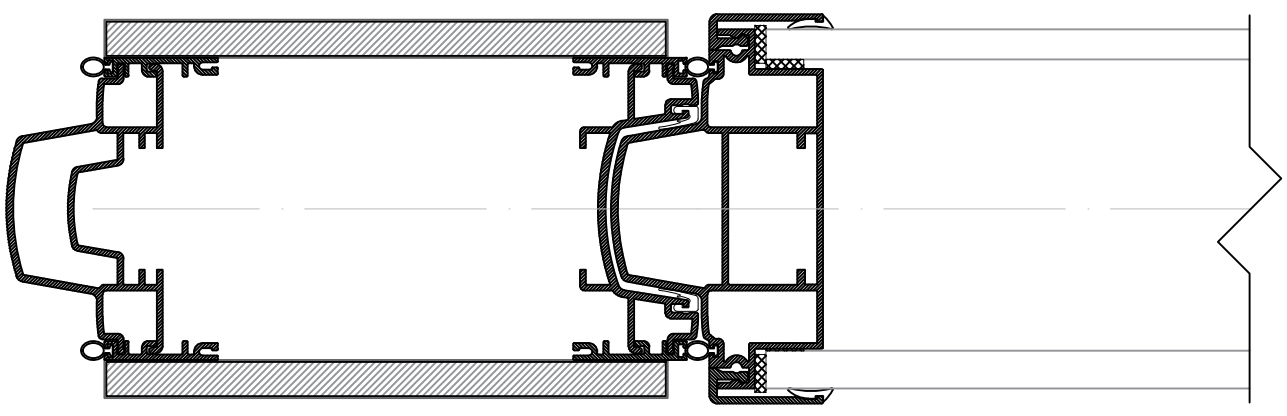
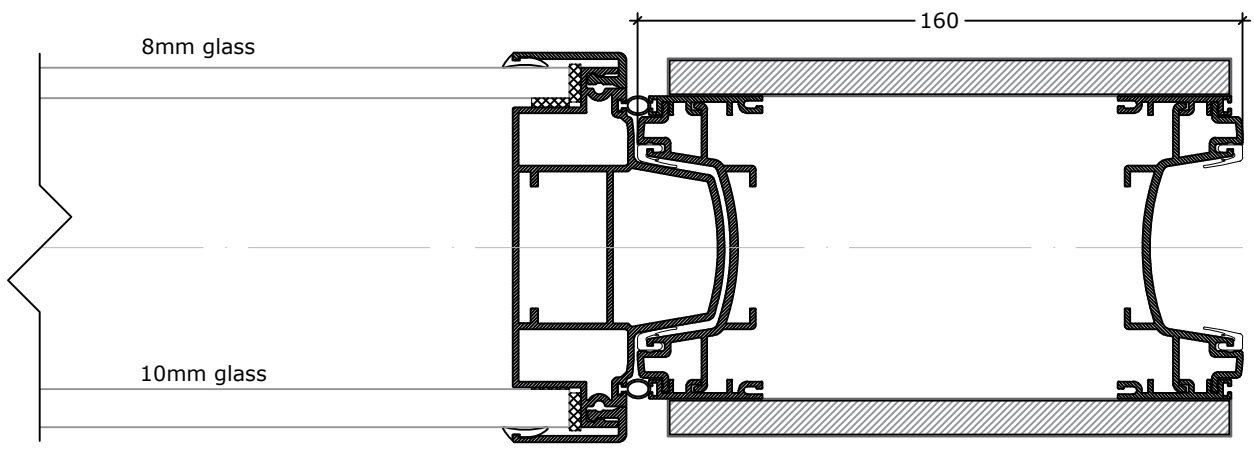

NOTE: Optional glass for 50dB is available.

	DEKO Tlf./Tel: +45 43 55 77 11 www.deko.dk / www.deko.com		Projekt/Project: DEKO Glaselement with Extension		
	Sags Nr./Case No.:	Emne/Subject: DEKO MV2 Glass 50 - Dorma Moveo MV2 Glass_V1C		Dato/Date: 2017-05-31	Tegn. Nr. Sheet No. 1/1
Mål/Scale: 1:2			Revideret/Revision: 2017-06-01-V01	Signatur Signature XX	

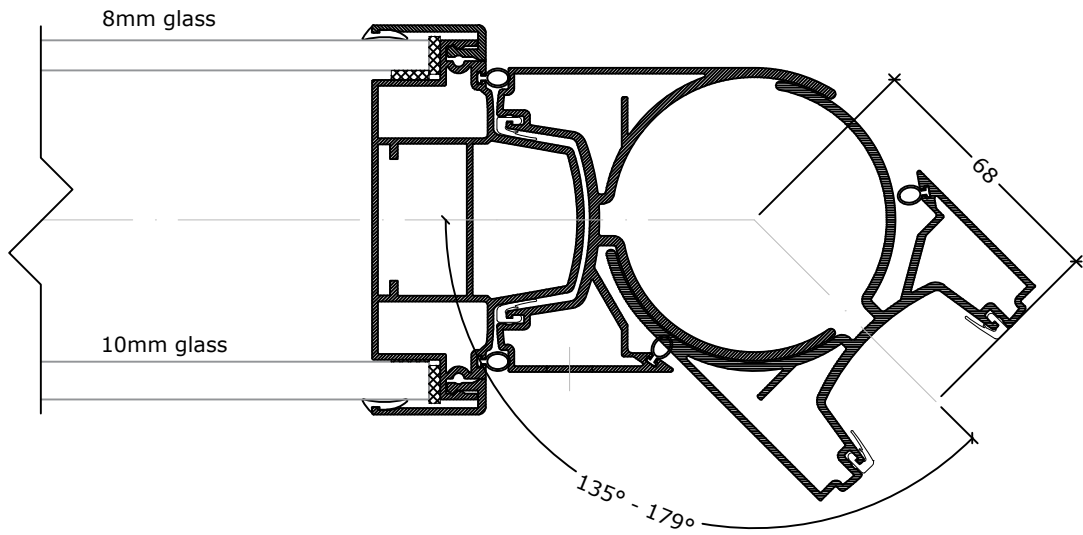

NOTE: Optional glass for 50dB is available.

	DEKO Tlf./Tel: +45 43 55 77 11 www.deko.dk / www.deko.com	Projekt/Project: DEKO 135° - 179° connection	
	Sags Nr./Case No.:	Emne/Subject: DEKO MV2 Glass 50 - Dorma Moveo MV2 Glass_V1D	Dato/Date: 2017-05-31
Mål/Scale: 1:2		Revideret/Revision: 2017-06-01-V01	Signatur Signature XX

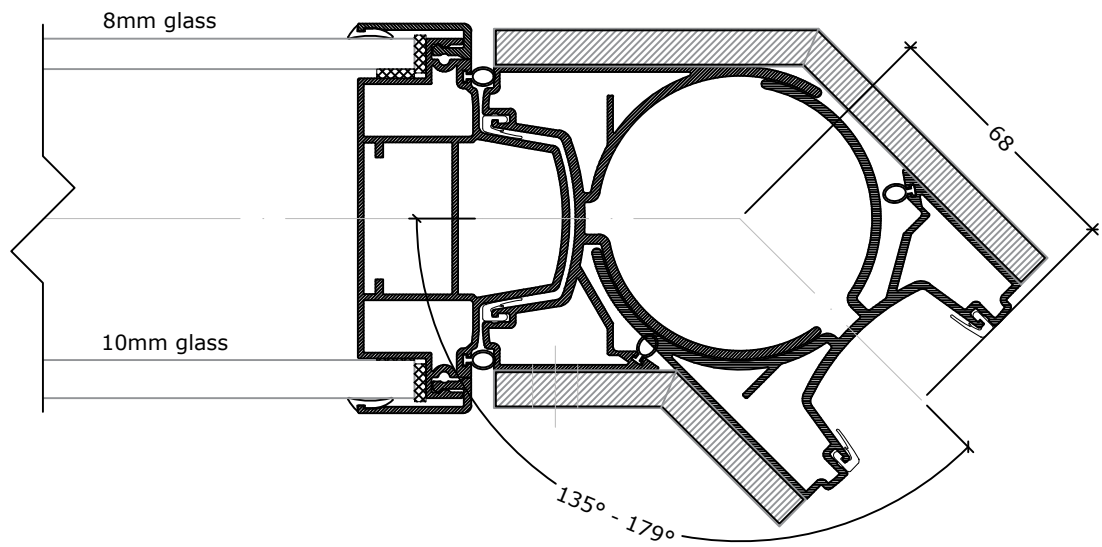

NOTE: Optional glass for 50dB is available.

	DEKO Tlf./Tel: +45 43 55 77 11 www.deko.dk / www.deko.com		Projekt/Project: DEKO 135° - 179° connection		
	Sags Nr./Case No.:	Emne/Subject: DEKO MV2 Glass 50 - Dorma Moveo MV2 Glass_V1E		Dato/Date: 2017-05-31	Tegn. Nr. Sheet No. 1/1
Mål/Scale: 1:2			Revideret/Revision: 2017-06-01-V01	Signatur Signature XX	

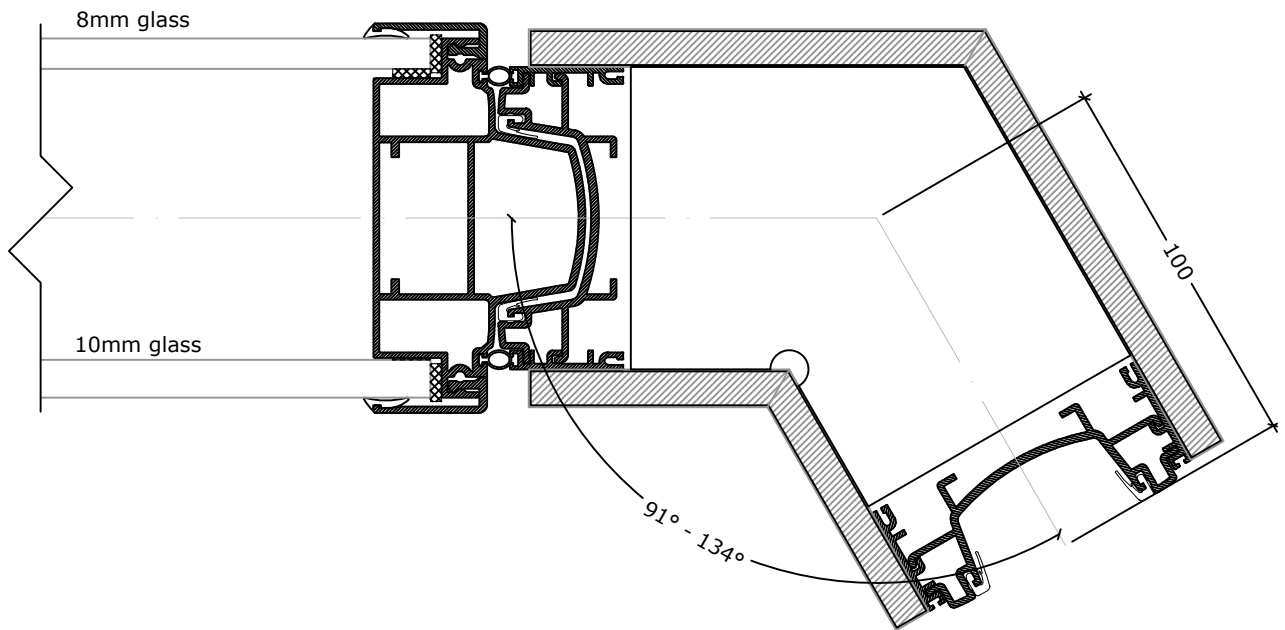

NOTE: Optional glass for 50dB is available.

	DEKO Tlf./Tel: +45 43 55 77 11 www.deko.dk / www.deko.com		Projekt/Project: DEKO 91° - 134° connection	
	Sags Nr./Case No.:	Emne/Subject: DEKO MV2 Glass 50 - Dorma Moveo MV2 Glass_V1F		Dato/Date: 2017-05-31
Mål/Scale: 1:2			Revideret/Revision: 2017-06-01-V01	Signatur Signature XX

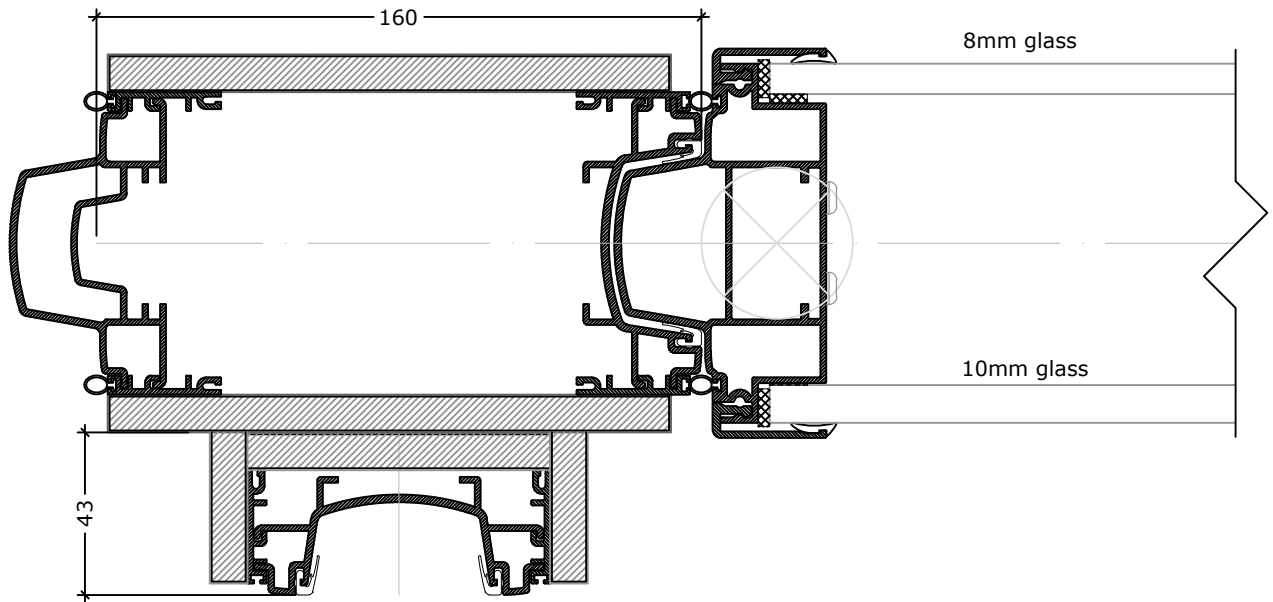

NOTE: Optional glass for 50dB is available.

	DEKO Tlf./Tel: +45 43 55 77 11 www.deko.dk / www.deko.com	Projekt/Project: DEKO 180° extension with "T" connection	
	Sags Nr./Case No.:	Emne/Subject: DEKO MV2 Glass 50 - Dorma Moveo MV2 Glass_V1G	Dato/Date: 2017-05-31
Mål/Scale: 1:2		Revideret/Revision: 2017-06-01-V01	Signatur Signature XX