

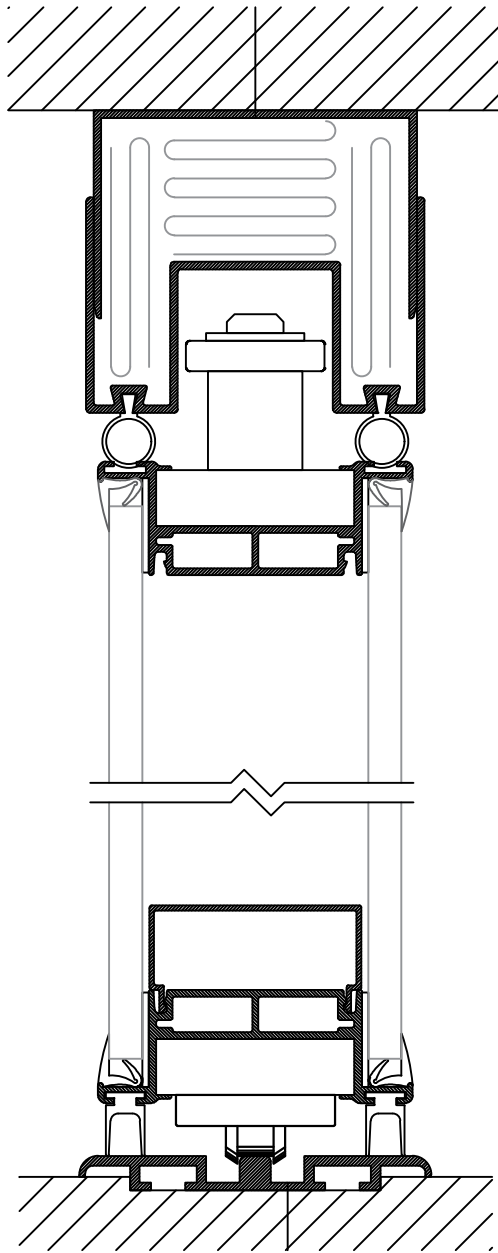

	<b>DEKO</b> Tlf./Tel: +45 43 55 77 11 www.deko.dk / www.deko.com	<b>Projekt/Project:</b> DEKO	
	<b>Sags Nr./Case No.:</b>	<b>Emne/Subject:</b> DEKO FV2 Glass Vertical section FV2 Glass_L1A+L3A	<b>Dato/Date:</b> 2017-06-01
<b>Mål/Scale:</b> 1:2		<b>Revideret/Revision:</b> 2017-06-01-V01	<b>Signatur Signature</b> XX



	<b>DEKO</b> Tlf./Tel: +45 43 55 77 11 www.deko.dk / www.deko.com	<b>Projekt/Project:</b> DEKO	
	<b>Sags Nr./Case No.:</b>	<b>Emne/Subject:</b> DEKO FV2 Glass Vertical section FV2 Glass_L1A+L3A	<b>Dato/Date:</b> 2017-06-01
<b>Mål/Scale:</b> 1:2		<b>Revideret/Revision:</b> 2017-06-01-V01	<b>Signatur Signature</b> XX

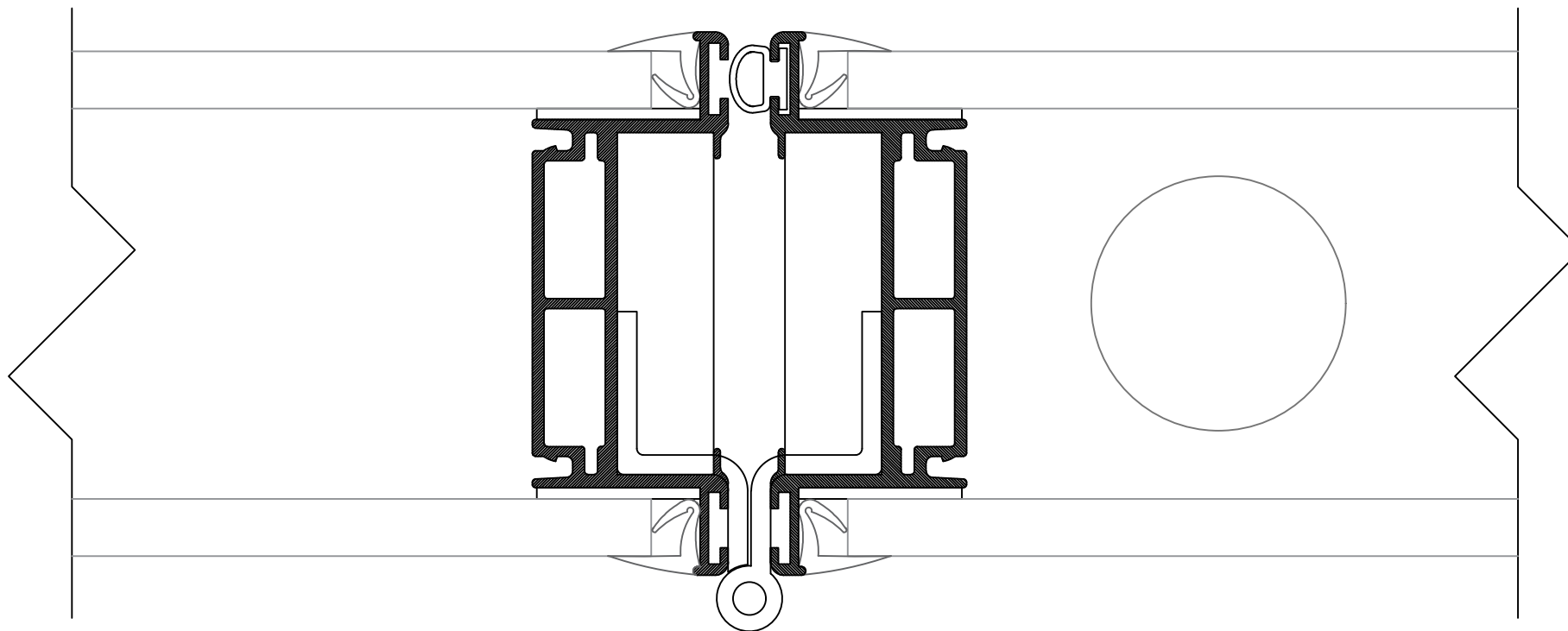

	<b>DEKO</b> Tlf./Tel: +45 43 55 77 11 www.deko.dk / www.deko.com		<b>Projekt/Project:</b> DEKO	
	<b>Sags Nr./Case No.:</b>		<b>Dato/Date:</b> 2017-06-01	<b>Tegn. Nr. Sheet No.</b> 1/1
<b>Mål/Scale:</b> 1:1	<b>Emne/Subject:</b> DEKO FV2 Glass FV2 Glass_V1A		<b>Revideret/Revision:</b> 2017-06-01-V01	<b>Signatur Signature</b> XX

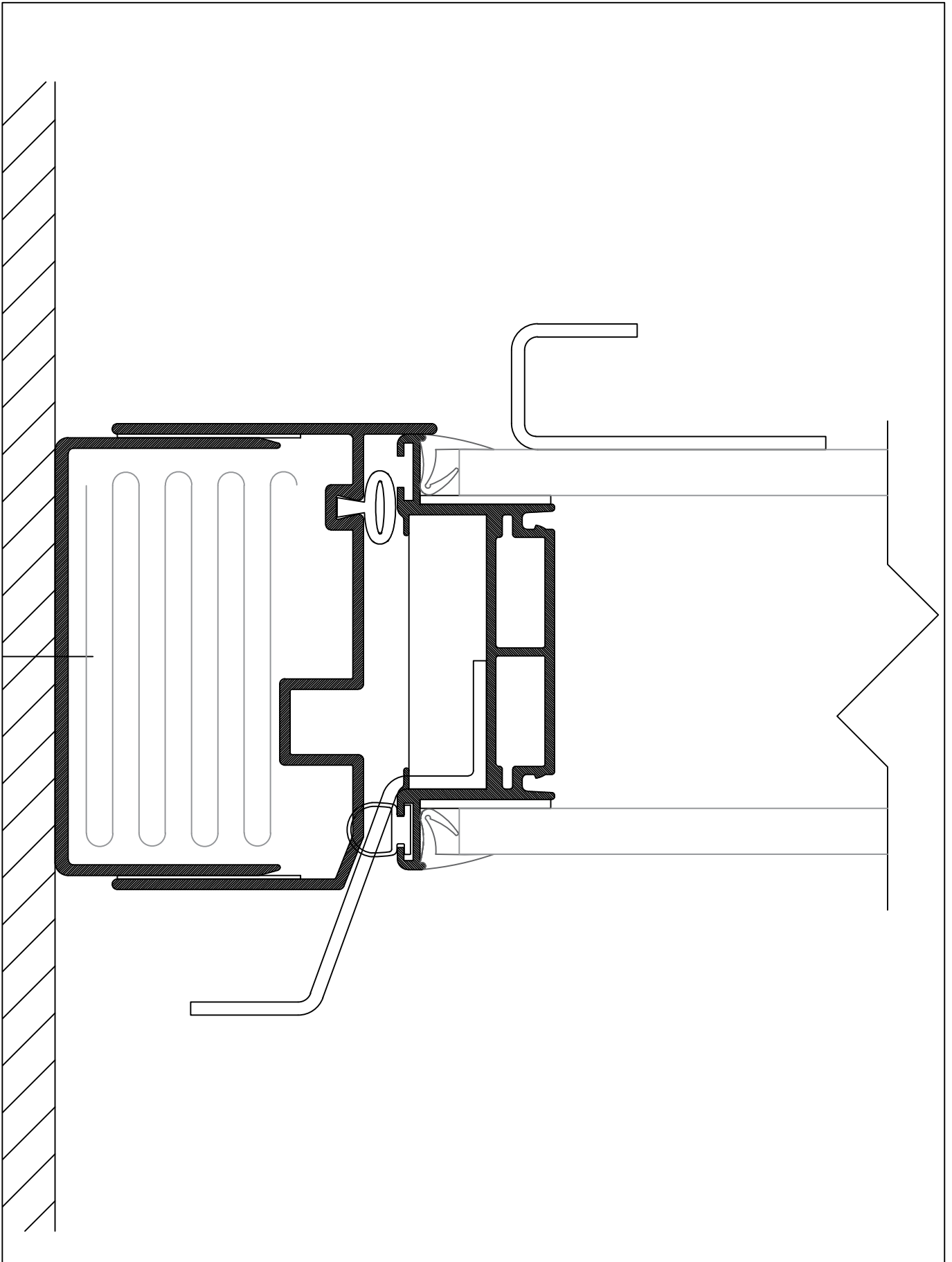

	<b>DEKO</b> Tlf./Tel: +45 43 55 77 11 www.deko.dk / www.deko.com	<b>Projekt/Project:</b> DEKO Wall starter [door closing side]	
	<b>Sags Nr./Case No.:</b>	<b>Emne/Subject:</b> DEKO FV2 Glass FV2 Glass_V7A	<b>Dato/Date:</b> 2017-06-01
<b>Mål/Scale:</b> 1:1		<b>Revideret/Revision:</b> 2017-06-01-V01	<b>Signatur Signature</b> XX

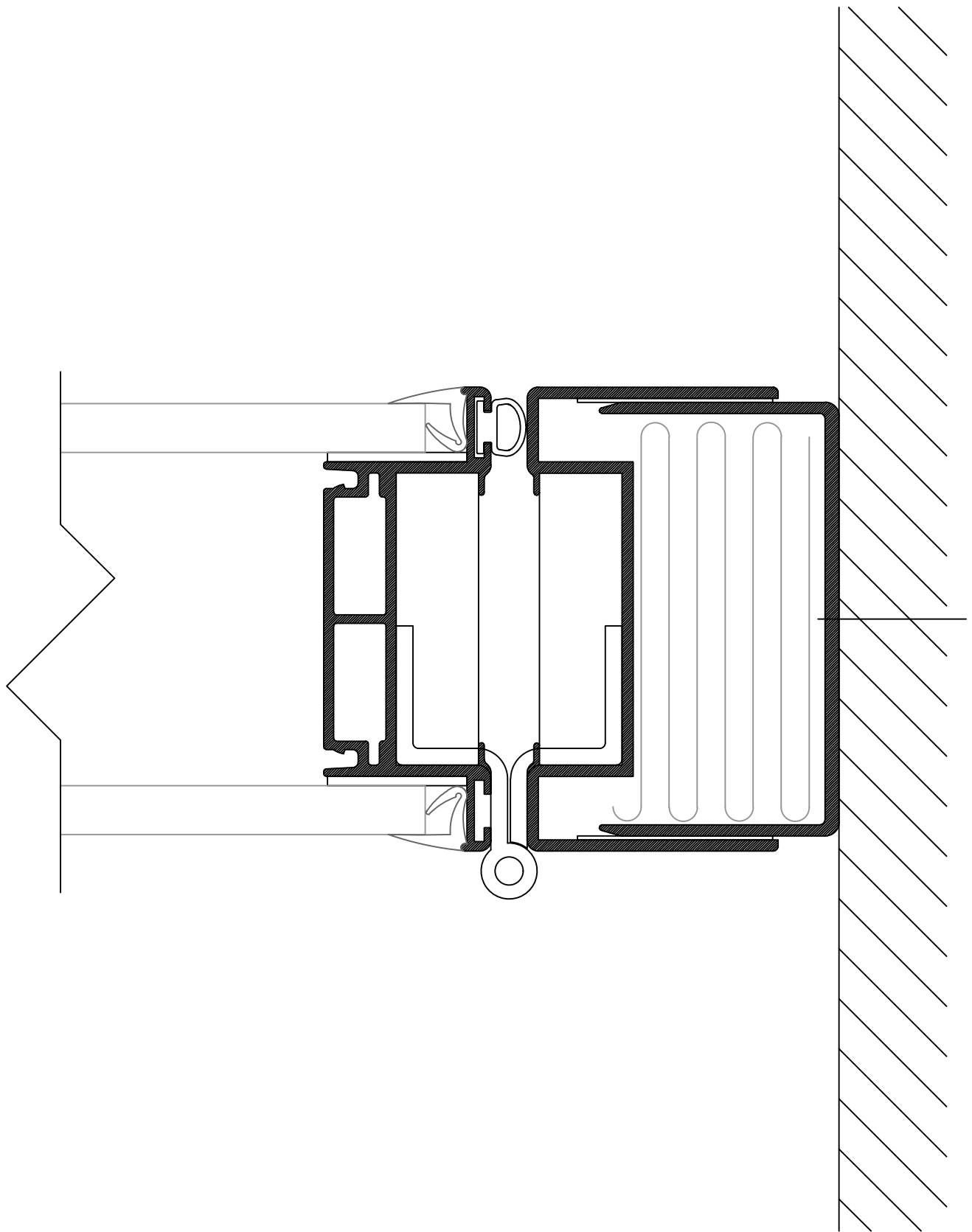

	<b>DEKO</b>	<b>Projekt/Project:</b>	
	Tlf./Tel: +45 43 55 77 11 www.deko.dk / www.deko.com	DEKO Wall starter	
<b>Sags Nr./Case No.:</b>	<b>Emne/Subject:</b>	<b>Dato/Date:</b>	<b>Tegn. Nr. Sheet No.</b> 1/1
<b>Mål/Scale:</b> 1:1	DEKO FV2 Glass	2017-06-01	<b>Signatur Signature</b> XX
	FV2 Glass_V7B	<b>Revideret/Revision:</b> 2017-06-01-V01	